

US00D868047S

(12) **United States Design Patent**  
**Zheng**

(10) **Patent No.:** **US D868,047 S**

(45) **Date of Patent:** **\*\* Nov. 26, 2019**

|   |                |        |                  |                       |
|---|----------------|--------|------------------|-----------------------|
| (54) <b>ANTENNA</b>   | 7,215,296 B2 † | 5/2007 | Abramov .....    | H01Q 3/24<br>343/83   |
| (71) Applicant: <b>Airgain Incorporated</b> , San Diego, CA<br>(US) | D546,821 S †   | 7/2007 | Oliver .....     | D14/23                |
|   | D549,696 S †   | 8/2007 | Oshima .....     | D14/23                |
|   | 7,333,067 B2 † | 2/2008 | Hung .....       | H01Q 1/36<br>343/70   |
| (72) Inventor: <b>Bei Zheng</b> , Zhang Jia Gang (CN)               | 7,336,959 B2 † | 2/2008 | Khitrik .....    | H04L 12/28<br>455/43  |
| (73) Assignee: <b>Airgain Incorporated</b> , San Diego, CA<br>(US)  | D573,589 S †   | 7/2008 | Montgomery ..... | D14/23                |
|   | 7,405,704 B1 † | 8/2008 | Lin .....        | H01Q 1/2266<br>343/70 |
| (**) Term: <b>15 Years</b>  | 7,477,195 B2 † | 1/2009 | Vance .....      | H01Q 9/0457<br>343/70 |
| (21) Appl. No.: <b>29/700,616</b>                                   | D592,195 S †   | 5/2009 | Wu .....         | D14/23                |

(Continued)

*Primary Examiner* — Jeffrey D Asch  
*Assistant Examiner* — Rebekah A Carusso  
(74) *Attorney, Agent, or Firm* — Clause Eight IPS;  
Michael Catania

**Related U.S. Application Data**

(62) Division of application No. 29/615,352, filed on Aug. 28, 2017, now Pat. No. Des. 856,983.

(51) **LOC (12) Cl.** ..... **14-03**

(52) **U.S. Cl.**  
USPC ..... **D14/230**

(58) **Field of Classification Search**  
USPC ..... D14/230–238, 238.1, 299, 343; D13/182  
CPC ..... H01Q 7/00; H01Q 13/10; H01Q 9/285;  
H01Q 19/30; H01Q 19/12; H01Q 1/36;  
H01Q 1/38; H04B 1/0475; H04B 1/034;  
H05K 11/00; G05D 1/0234; G06K  
19/07749

See application file for complete search history.

(56) **References Cited**

U.S. PATENT DOCUMENTS

|                |         |            |                         |
|----------------|---------|------------|-------------------------|
| 6,667,718 B2 * | 12/2003 | Back ..... | H01Q 1/38<br>343/700 MS |
| D493,446 S *   | 7/2004  | Hung ..... | D14/230                 |
| 7,061,437 B2 † | 6/2006  | Lin .....  | H01Q 9/0421<br>343/70   |
| 7,148,849 B2 † | 12/2006 | Lin .....  | H01Q 1/243<br>343/70    |

(57) **CLAIM**

The ornamental design for an antenna, as shown and described.

**DESCRIPTION**

FIG. 1 is a top plan view of an antenna, showing my new design;  
FIG. 2 is a front elevation view thereof;  
FIG. 3 is a bottom plan view thereof;  
FIG. 4 is a top perspective view thereof;  
FIG. 5 is a top plan view showing only the top portion of the design, with the broken line environment not shown;  
FIG. 6 is a front elevation view, with the broken line environment not shown; and,  
FIG. 7 is a bottom plan view showing only the bottom portion of the design, with the broken line environment not shown.  
The broken lines show environment only and form no part of the claimed design.

**1 Claim, 1 Drawing Sheet**

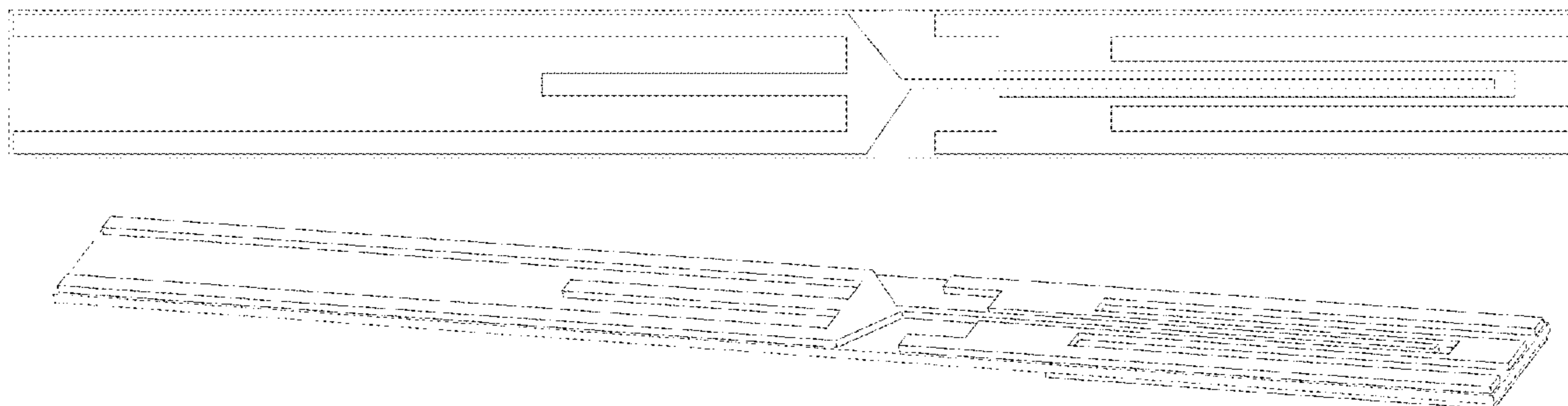

(56)

References Cited

U.S. PATENT DOCUMENTS

|                |         |           |       |              |                   |         |                   |       |               |
|----------------|---------|-----------|-------|--------------|-------------------|---------|-------------------|-------|---------------|
| 7,570,215 B2 ‡ | 8/2009  | Abramov   | ..... | H01Q 3/242   | D706,751 S ‡      | 6/2014  | Chang             | ..... | D14/23        |
|                |         |           |       | 343/70       | D708,602 S ‡      | 7/2014  | Gosalia           | ..... | D14/23        |
| D599,334 S ‡   | 9/2009  | Chiang    | ..... | D14/23       | D709,053 S ‡      | 7/2014  | Chang             | ..... | D14/23        |
| D599,787 S ‡   | 9/2009  | Deguchi   | ..... | D14/230      | D710,339 S *      | 8/2014  | Bishop            | ..... | D14/230       |
| D606,053 S ‡   | 12/2009 | Wu        | ..... | D14/23       | D710,832 S ‡      | 8/2014  | Yang              | ..... | D14/23        |
| D607,442 S ‡   | 1/2010  | Su        | ..... | D14/23       | D710,833 S *      | 8/2014  | Zheng             | ..... | D14/230       |
| D608,769 S ‡   | 1/2010  | Bufe      | ..... | D14/23       | 8,854,265 B1 ‡    | 10/2014 | Yang              | ..... | H01Q 9/045    |
| D612,368 S ‡   | 3/2010  | Yang      | ..... | D14/23       |                   |         |                   |       | 343/70        |
| 7,705,783 B2 ‡ | 4/2010  | Rao       | ..... | H01Q 1/243   | D716,775 S ‡      | 11/2014 | Bidermann         | ..... | D14/23        |
|                |         |           |       | 343/70       | D766,883 S ‡      | 9/2016  | Yang              | ..... | D14/230       |
| 7,729,662 B2 ‡ | 6/2010  | Abramov   | ..... | H04B 7/0408  | D796,492 S ‡      | 9/2017  | He                | ..... | D14/230       |
|                |         |           |       | 370/33       | D798,280 S ‡      | 9/2017  | Zheng             | ..... | D14/230       |
| D621,819 S ‡   | 8/2010  | Tsai      | ..... | D14/23       | D814,448 S *      | 4/2018  | Montgomery        | ..... | D14/230       |
| 7,843,390 B2 ‡ | 11/2010 | Liu       | ..... | H01Q 9/42    | D822,649 S ‡      | 7/2018  | He                | ..... | D14/230       |
|                |         |           |       | 343/70       | D826,910 S *      | 8/2018  | Zhao              | ..... | D14/230       |
| D633,483 S ‡   | 3/2011  | Su        | ..... | D14/23       | D838,261 S *      | 1/2019  | He                | ..... | D14/230       |
| D635,127 S ‡   | 3/2011  | Tsai      | ..... | D14/23       | D849,724 S *      | 5/2019  | He                | ..... | D14/230       |
| 7,907,971 B2 ‡ | 3/2011  | Salo      | ..... | H04B 1/1027  | D850,426 S *      | 6/2019  | He                | ..... | D14/230       |
|                |         |           |       | 455/56       | D859,374 S *      | 9/2019  | He                | ..... | D14/230       |
| D635,560 S ‡   | 4/2011  | Tsai      | ..... | D14/23       | 2002/0003499 A1 ‡ | 1/2002  | Kouam             | ..... | H01Q 1/243    |
| D635,963 S ‡   | 4/2011  | Podduturi | ..... | D14/23       |                   |         |                   |       | 343/70        |
| D635,964 S *   | 4/2011  | Podduturi | ..... | D14/230      | 2004/0222936 A1 ‡ | 11/2004 | Hung              | ..... | H01Q 1/38     |
| D635,965 S ‡   | 4/2011  | Mi        | ..... | D14/23       |                   |         |                   |       | 343/79        |
| D636,382 S ‡   | 4/2011  | Podduturi | ..... | D14/23       | 2005/0073462 A1 ‡ | 4/2005  | Lin               | ..... | G06F 1/1616   |
| 7,965,242 B2 ‡ | 6/2011  | Abramov   | ..... | H01Q 1/521   |                   |         |                   |       | 343/70        |
|                |         |           |       | 343/70       | 2005/0190108 A1 ‡ | 9/2005  | Lin               | ..... | H01Q 9/42     |
| D649,962 S ‡   | 12/2011 | Tseng     | ..... | D14/23       |                   |         |                   |       | 343/70        |
| D651,198 S ‡   | 12/2011 | Mi        | ..... | D14/23       | 2006/0208900 A1 ‡ | 9/2006  | Tavassoli Hozouri | ..... | G06K 19/07749 |
| D654,059 S ‡   | 2/2012  | Mi        | ..... | D14/23       |                   |         |                   |       | 340/57        |
| D654,060 S ‡   | 2/2012  | Ko        | ..... | D14/23       | 2007/0030203 A1 ‡ | 2/2007  | Tsai              | ..... | H01Q 9/42     |
| 8,115,618 B2 * | 2/2012  | Robertson | ..... | A61B 1/00016 |                   |         |                   |       | 343/70        |
|                |         |           |       | 340/539.12   | 2008/0150829 A1 ‡ | 6/2008  | Lin               | ..... | G06F 1/1616   |
| D658,639 S ‡   | 5/2012  | Huang     | ..... | D14/23       |                   |         |                   |       | 343/86        |
| D659,129 S ‡   | 5/2012  | Mi        | ..... | D14/23       | 2008/0246668 A1 ‡ | 10/2008 | Qi                | ..... | H01Q 1/243    |
| D659,685 S ‡   | 5/2012  | Huang     | ..... | D14/23       |                   |         |                   |       | 343/702       |
| D659,688 S ‡   | 5/2012  | Huang     | ..... | D14/23       | 2009/0002244 A1 ‡ | 1/2009  | Woo               | ..... | H01Q 1/38     |
| 8,175,036 B2 ‡ | 5/2012  | Visuri    | ..... | H04L 1/1874  |                   |         |                   |       | 343/70        |
|                |         |           |       | 370/32       | 2009/0058739 A1 ‡ | 3/2009  | Konishi           | ..... | G06F 1/1616   |
| 8,184,601 B2 ‡ | 5/2012  | Abramov   | ..... | H01Q 3/24    |                   |         |                   |       | 343/70        |
|                |         |           |       | 370/31       | 2009/0135072 A1 ‡ | 5/2009  | Ke                | ..... | H01Q 1/36     |
| D662,916 S ‡   | 7/2012  | Huang     | ..... | D14/23       |                   |         |                   |       | 343/70        |
| 8,248,970 B2 ‡ | 8/2012  | Abramov   | ..... | H04B 7/0617  | 2009/0262028 A1 ‡ | 10/2009 | Mumbru            | ..... | H01Q 5/371    |
|                |         |           |       | 370/26       |                   |         |                   |       | 343/70        |
| D671,097 S ‡   | 11/2012 | Mi        | ..... | D14/23       | 2010/0060526 A1 * | 3/2010  | Cheng             | ..... | H01Q 1/38     |
| 8,310,402 B2 ‡ | 11/2012 | Yang      | ..... | H01Q 1/38    |                   |         |                   |       | 343/700 MS    |
|                |         |           |       | 343/70       | 2010/0188297 A1 ‡ | 7/2010  | Chen              | ..... | H01Q 1/243    |
| D676,429 S ‡   | 2/2013  | Gosalia   | ..... | D14/13       |                   |         |                   |       | 343/70        |
| D678,255 S ‡   | 3/2013  | Ko        | ..... | D14/23       | 2010/0309067 A1 ‡ | 12/2010 | Tsou              | ..... | H01Q 3/26     |
| 8,423,084 B2 ‡ | 4/2013  | Abramov   | ..... | H01Q 1/246   |                   |         |                   |       | 343/72        |
|                |         |           |       | 370/33       | 2011/0006950 A1 ‡ | 1/2011  | Park              | ..... | H01Q 9/0407   |
| D682,813 S ‡   | 5/2013  | Huang     | ..... | D14/230      |                   |         |                   |       | 343/70        |
| D684,565 S ‡   | 6/2013  | Wei       | ..... | D14/23       | 2011/0220727 A1 * | 9/2011  | Lee               | ..... | H01Q 1/2208   |
| D684,954 S ‡   | 6/2013  | Huang     | ..... | D14/230      |                   |         |                   |       | 235/492       |
| D685,352 S ‡   | 7/2013  | Wei       | ..... | D14/23       | 2012/0038514 A1 ‡ | 2/2012  | Bang              | ..... | H05K 1/16     |
| D685,772 S ‡   | 7/2013  | Zheng     | ..... | D14/23       |                   |         |                   |       | 343/70        |
| D686,600 S ‡   | 7/2013  | Yang      | ..... | D14/23       | 2012/0229348 A1 ‡ | 9/2012  | Chiang            | ..... | H01Q 1/2266   |
| D689,474 S ‡   | 9/2013  | Yang      | ..... | D14/23       |                   |         |                   |       | 343/70        |
| D692,870 S ‡   | 11/2013 | He        | ..... | D14/23       | 2012/0242546 A1 ‡ | 9/2012  | Hu                | ..... | H01Q 1/243    |
| D694,738 S ‡   | 12/2013 | Yang      | ..... | D14/23       |                   |         |                   |       | 343/70        |
| D695,279 S ‡   | 12/2013 | Yang      | ..... | D14/23       | 2013/0315511 A1 * | 11/2013 | Chen              | ..... | G06K 19/07745 |
| D695,280 S ‡   | 12/2013 | Yang      | ..... | D14/23       |                   |         |                   |       | 383/116       |
| D703,195 S ‡   | 4/2014  | Zheng     | ..... | D14/23       | 2016/0012329 A1 * | 1/2016  | Machado           | ..... | G06K 19/07786 |
| D703,196 S ‡   | 4/2014  | Zheng     | ..... | D14/23       |                   |         |                   |       | 235/492       |
| D706,247 S ‡   | 6/2014  | Zheng     | ..... | D14/23       |                   |         |                   |       |               |
| D706,750 S ‡   | 6/2014  | Bringuier | ..... | D14/23       |                   |         |                   |       |               |

\* cited by examiner

‡ imported from a related application

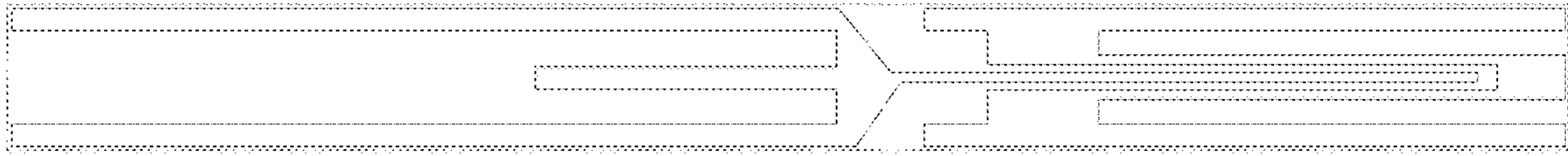

FIG. 1

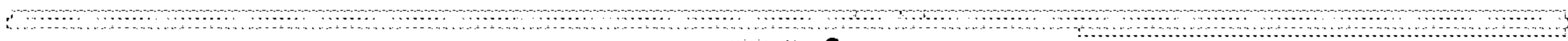

FIG. 2



FIG. 3

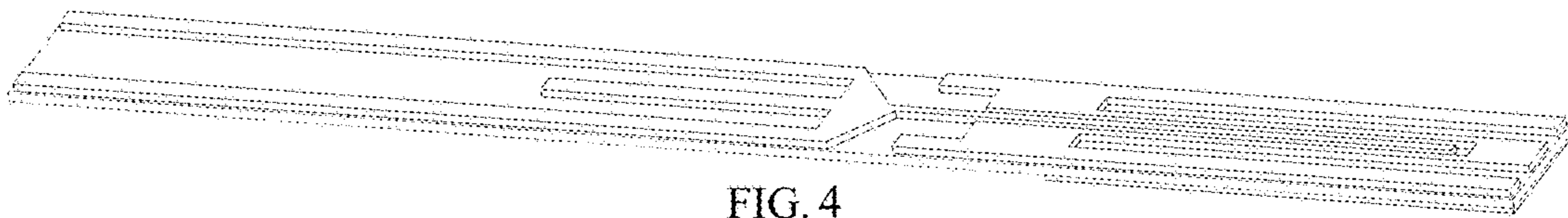

FIG. 4

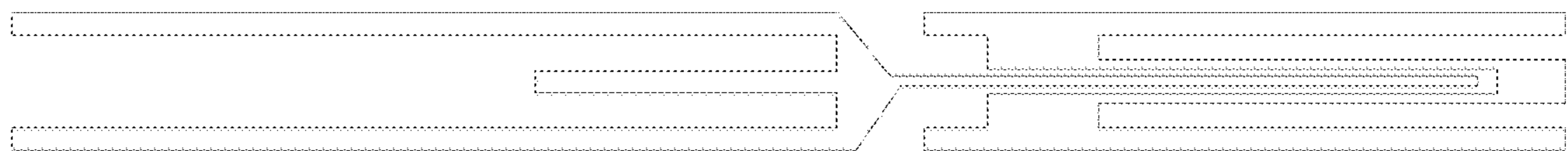

FIG. 5

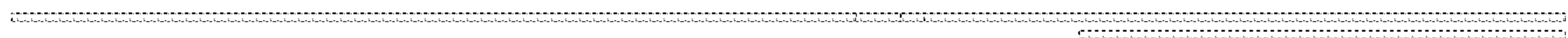

FIG. 6

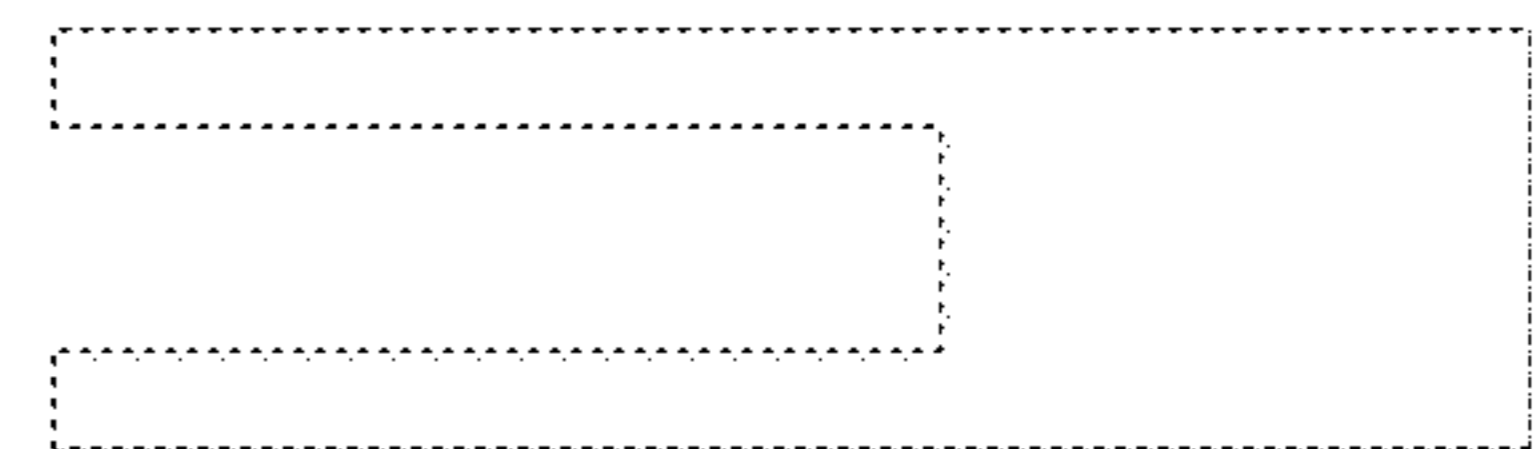

FIG. 7