



US00D868032S

(12) **United States Design Patent** (10) **Patent No.:** **US D868,032 S**
Wen (45) **Date of Patent:** **** Nov. 26, 2019**

(54) **SOUND DEVICE**

(71) Applicant: **Long Wen**, Guangdong (CN)

(72) Inventor: **Long Wen**, Guangdong (CN)

(73) Assignee: **Shenzhen BAXIA Technology Co., Ltd**, Shenzhen, Guangdong (CN)

(**) Term: **15 Years**

(21) Appl. No.: **29/619,427**

(22) Filed: **Sep. 29, 2017**

(51) **LOC (12) Cl.** **14-01**

(52) **U.S. Cl.**
USPC **D14/216**

(58) **Field of Classification Search**
USPC D14/167, 168, 170–172, 188, 194–196,
D14/204, 209.1, 210–216, 219, 221, 222,
D14/224, 239, 496

CPC B60R 11/0217; G06F 1/1688; G10K 9/22;
G10K 11/004; H03F 1/327; H04M 1/03;
H04M 1/035; H04N 5/642; H04N
21/4852; H04R 1/02; H04R 1/06; H04R
1/021; H04R 1/025; H04R 1/026; H04R
1/028; H04R 1/105; H04R 1/323; H04R
1/403; H04R 1/2803; H04R 1/2834;
H04R 5/02; H04R 7/20; H04R 9/06;
H04R 9/025; H04R 2201/021; H04R
2400/00; H04R 2400/07; H04R 2499/11;
H04R 2499/13; H04R 2499/15; H04S
3/00; H04S 7/30

See application file for complete search history.

(56) **References Cited**

U.S. PATENT DOCUMENTS

| | | | |
|--------------|---------|------------------|-----------|
| D802,559 S * | 11/2017 | Holzer | D14/210 |
| D815,149 S * | 4/2018 | Langhammer | D14/496 |
| D817,928 S * | 5/2018 | Holzer | D14/216 |
| D818,991 S * | 5/2018 | Zhang | D14/216 |
| D820,318 S * | 6/2018 | Mullins | D14/496 |
| D826,205 S * | 8/2018 | Langhammer | D14/203.6 |
| D828,333 S * | 9/2018 | Hu | D14/216 |
| D829,242 S * | 9/2018 | Laine | D14/496 |

* cited by examiner

Primary Examiner — Keli L Hill

(57) **CLAIM**

The ornamental design for a sound device, as shown and described.

DESCRIPTION

FIG. 1 is a perspective view of a sound device showing my new design;
FIG. 2 is a front elevation view thereof;
FIG. 3 is a rear elevation view thereof;
FIG. 4 is a left side elevation view thereof;
FIG. 5 is a right side elevation view thereof;
FIG. 6 is a top plan view thereof; and,
FIG. 7 is a bottom plan view thereof.
The broken lines in the figures depict portions of the article which form no part of the claimed design.

1 Claim, 7 Drawing Sheets

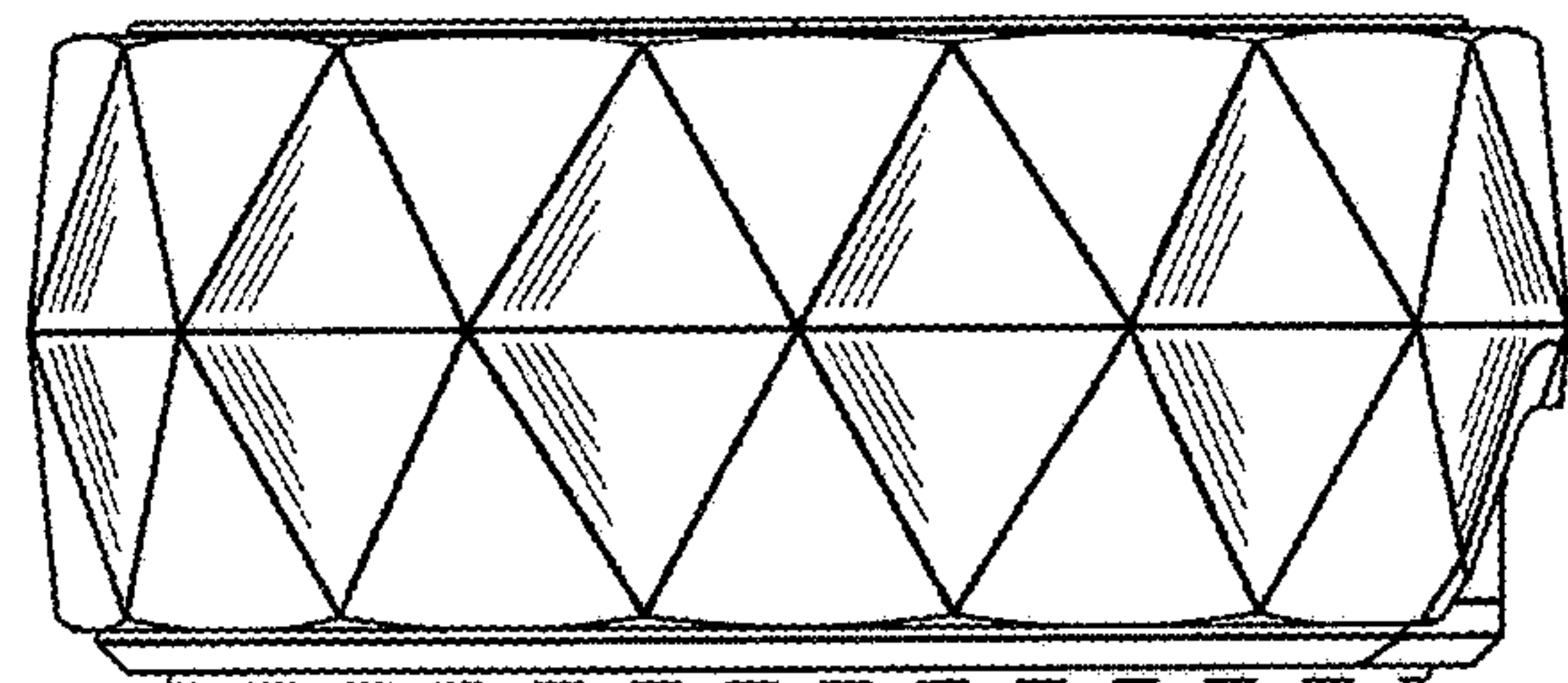
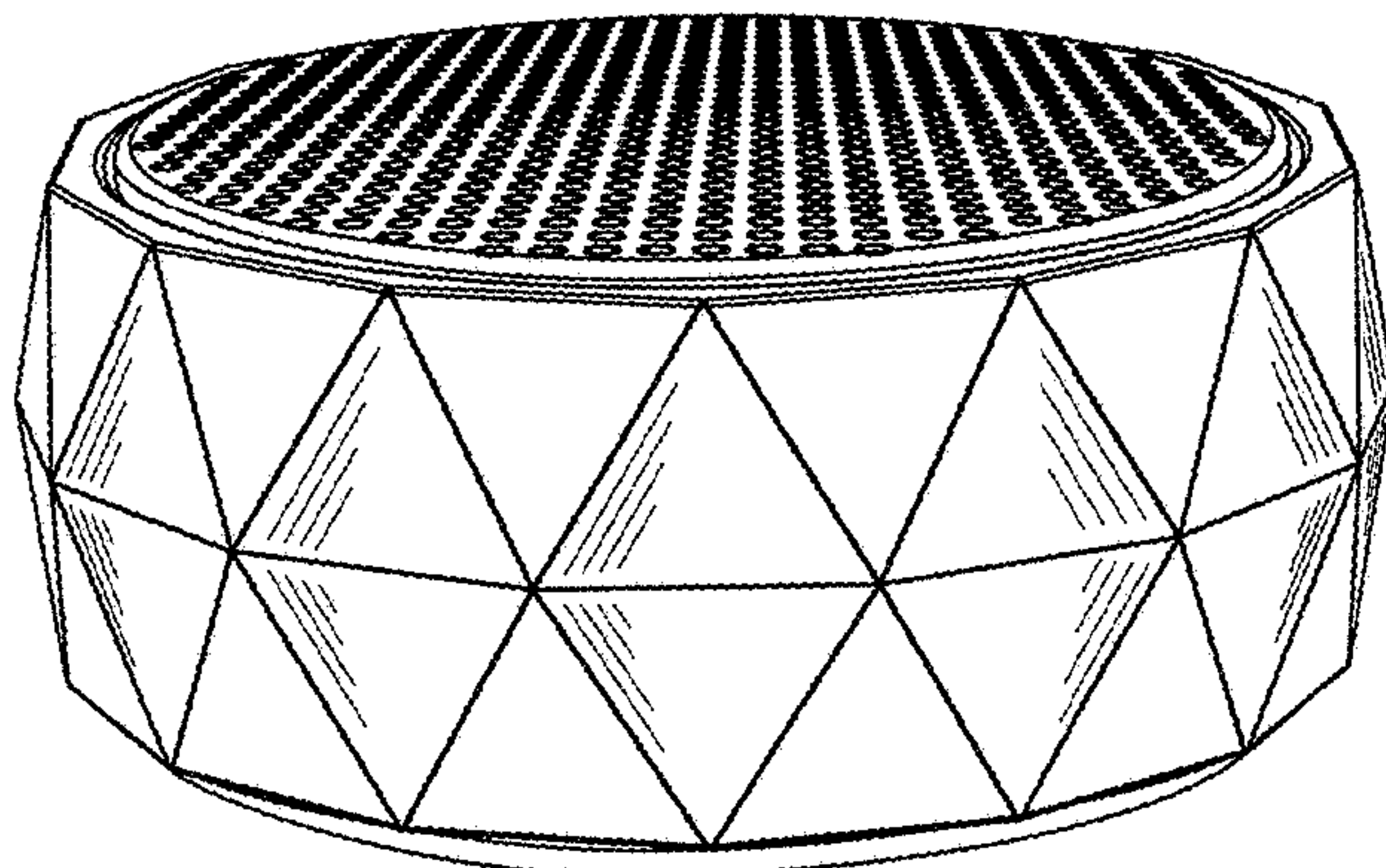

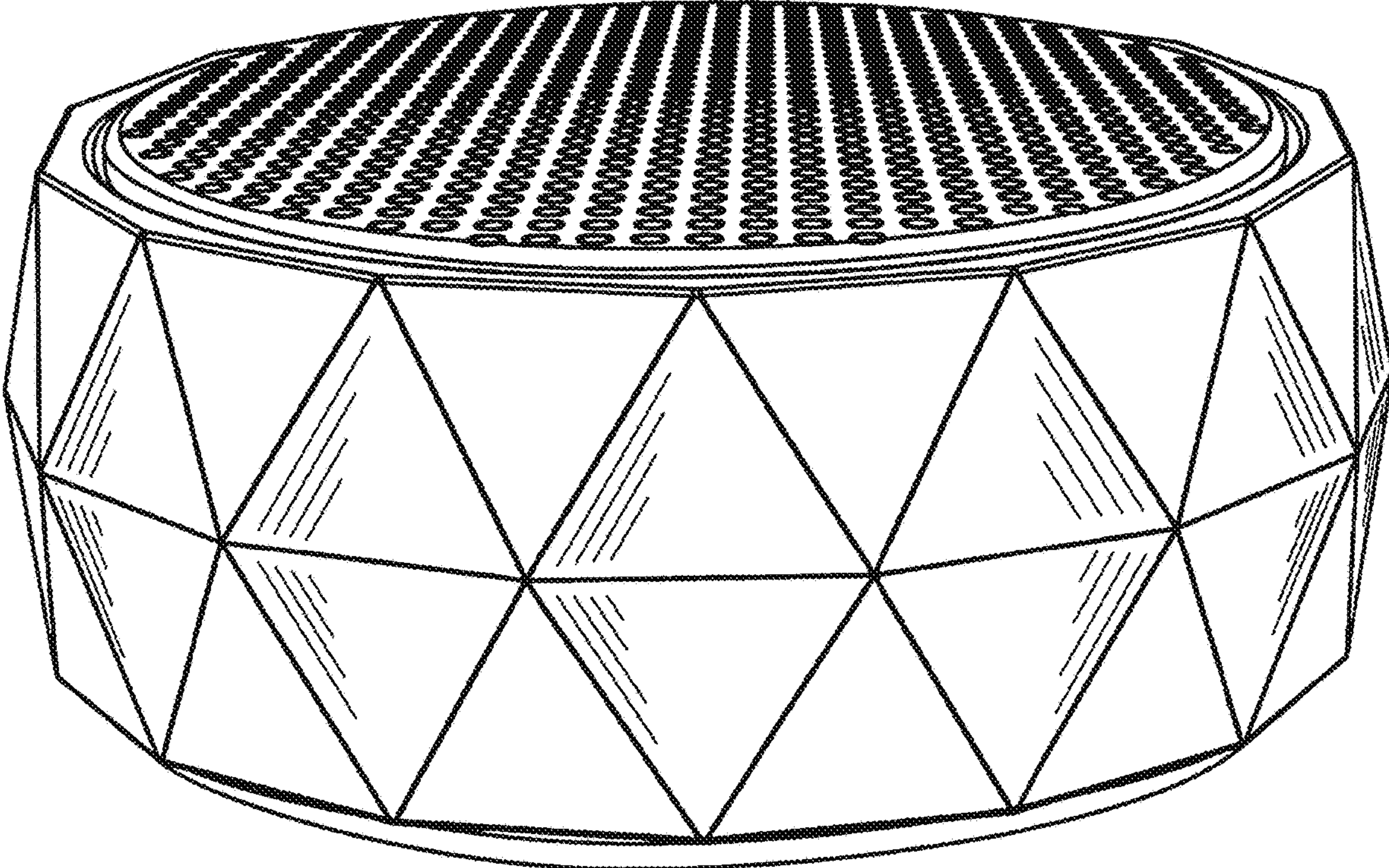

FIG.1

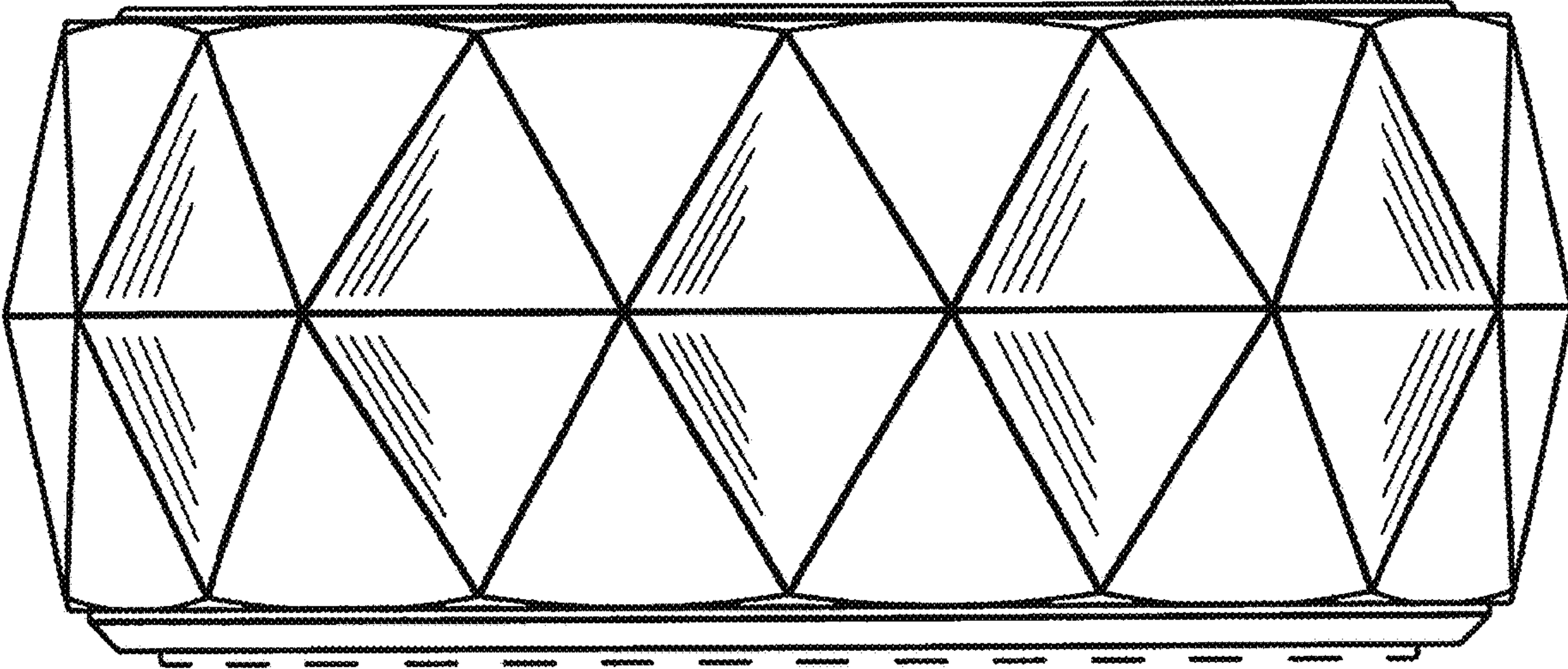

FIG.2

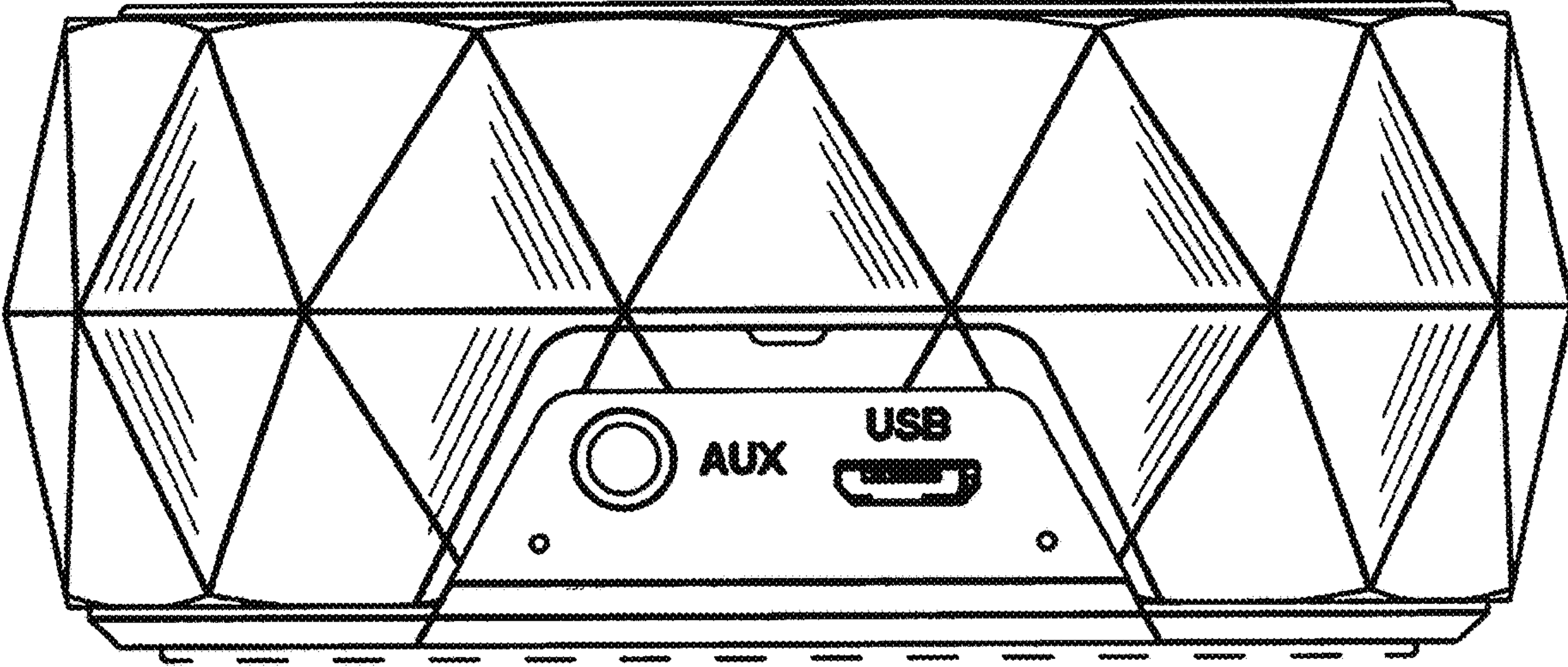

FIG.3

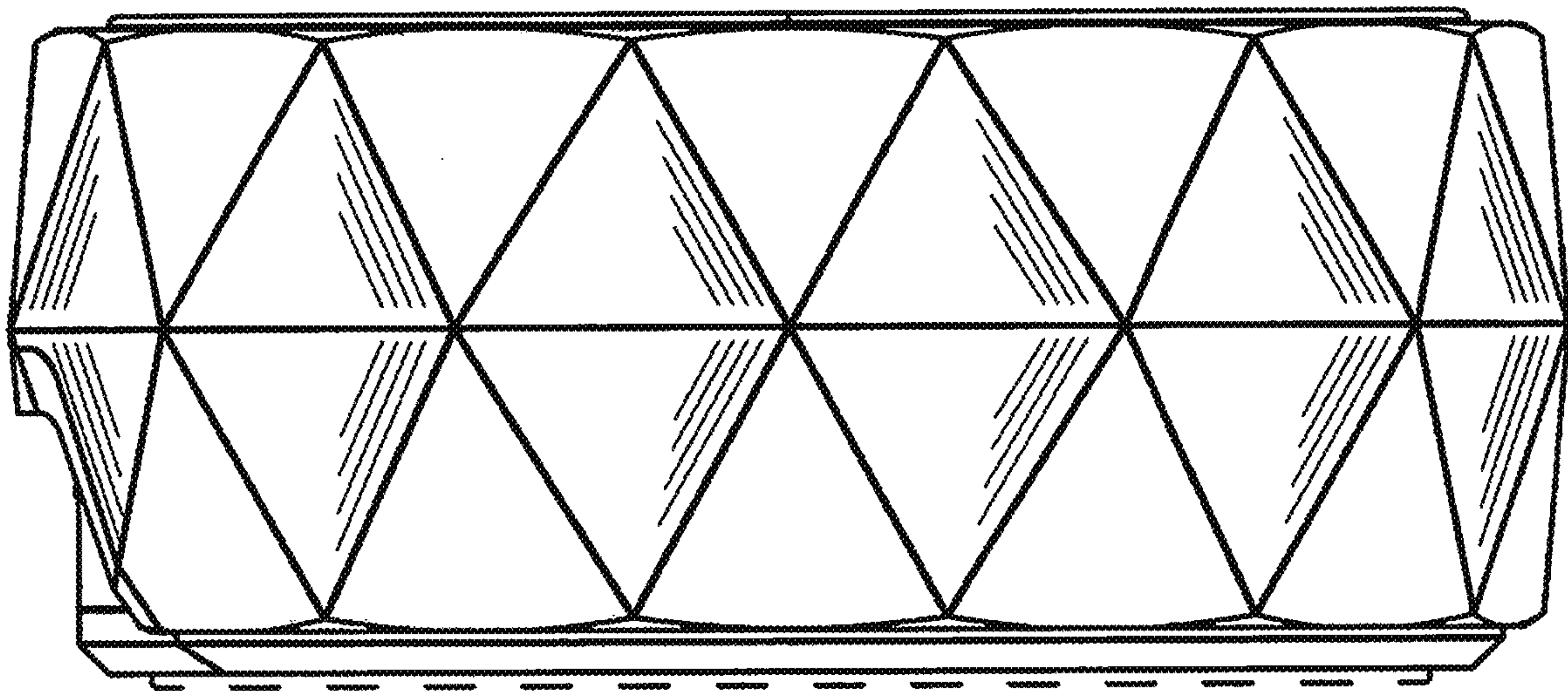

FIG.4

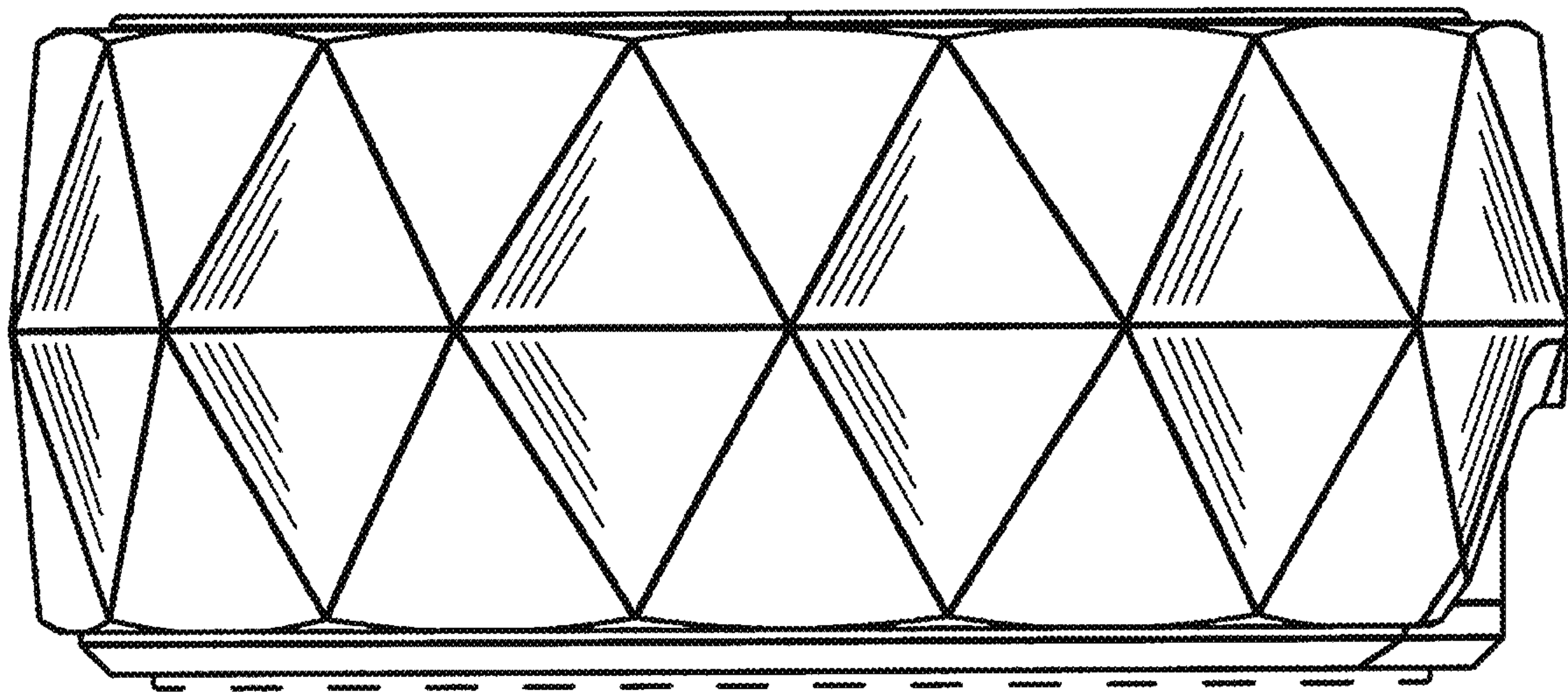

FIG.5

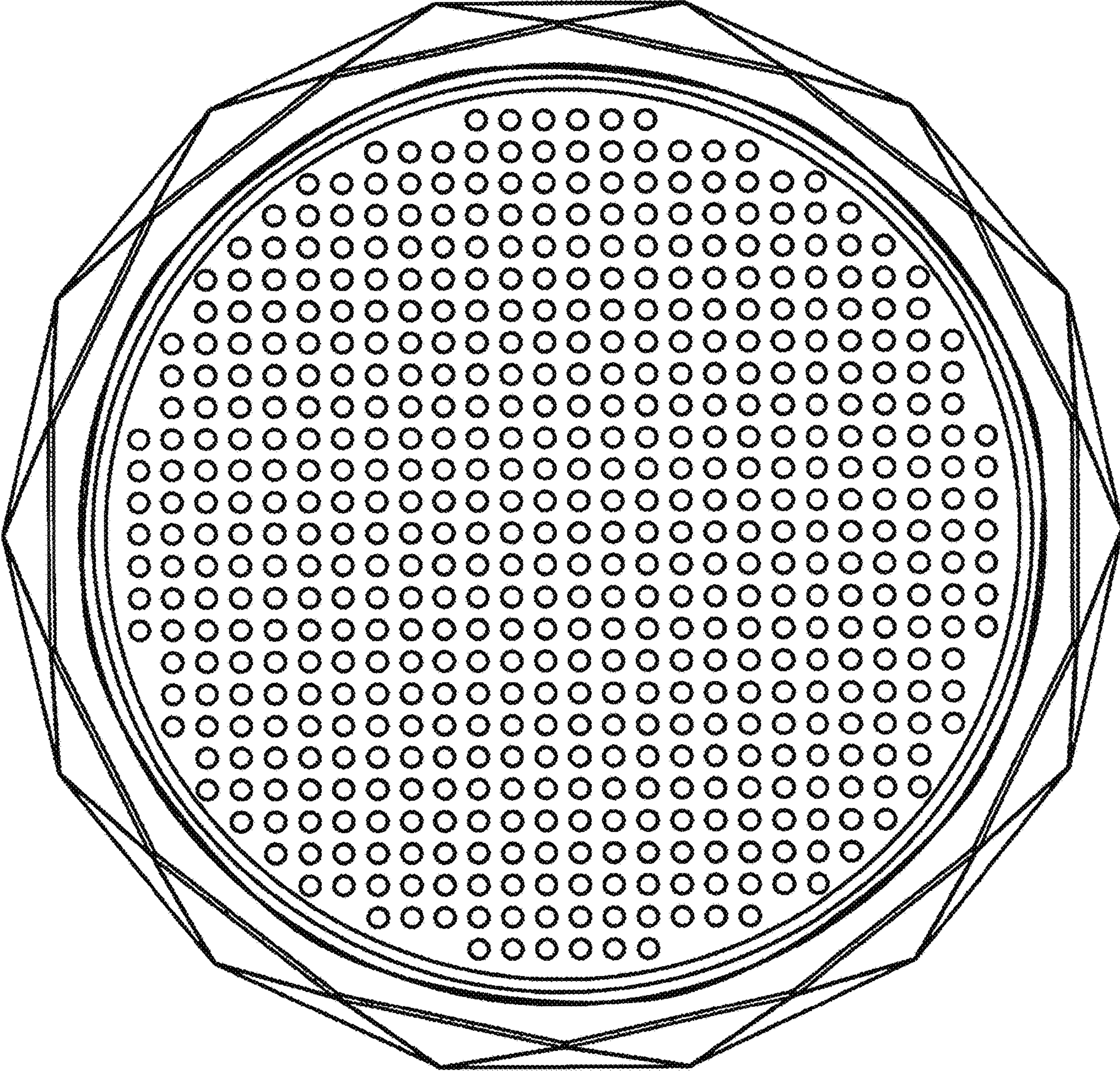

FIG.6

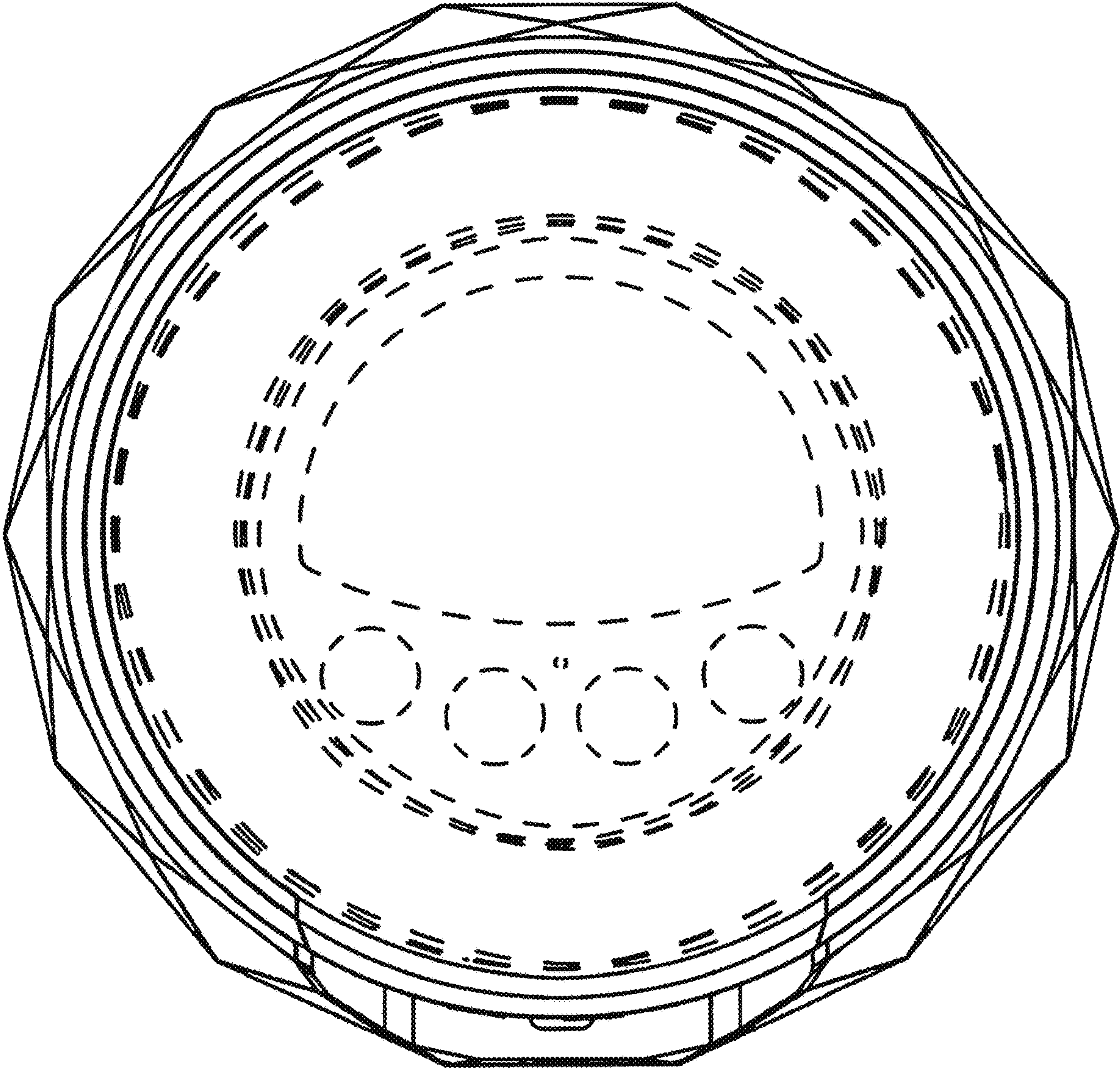

FIG. 7