



US00D867938S

(12) **United States Design Patent** (10) **Patent No.:** **US D867,938 S**  
**Brockway et al.** (45) **Date of Patent:** **\*\* Nov. 26, 2019**

(54) **KICKSTAND**

(71) Applicant: **Medline Industries, Inc.**, Northfield, IL (US)

(72) Inventors: **Todd Brockway**, Vernon Hills, IL (US);  
**Emily Berman**, Park Ridge, IL (US);  
**Caren Wax**, Deerfield, IL (US);  
**Tambra Martin**, Trevor, WI (US);  
**William Elliott Brooks**, Chicago, IL (US);  
**Robert W. Sheldon**, Winnetka, IL (US);  
**Gregory J. Foster**, Chicago, IL (US)

(73) Assignee: **Medline Industries, Inc.**, Northfield, IL (US)

(\*\*) Term: **15 Years**

(21) Appl. No.: **29/612,031**

(22) Filed: **Jul. 27, 2017**

(51) **LOC (12) Cl.** ..... **12-12**

(52) **U.S. Cl.**  
USPC ..... **D12/133**

(58) **Field of Classification Search**  
USPC ..... D12/128–133  
CPC ..... A61H 3/00; A61H 3/04; A61H  
2003/001–007; A61H 2003/043; A61H  
2003/046

See application file for complete search history.

(56) **References Cited**

U.S. PATENT DOCUMENTS

D681,642	S	*	5/2013	Meadows	.....	D14/447
D721,013	S	*	1/2015	Fragassi	.....	D12/111
D728,580	S	*	5/2015	Campbell	.....	D14/447
D777,606	S	*	1/2017	Dai	.....	D12/111
D803,222	S	*	11/2017	Cheng	.....	D14/440
D829,722	S	*	10/2018	Kim	.....	D14/447
2017/0055660	A1	*	3/2017	Tien	.....	A45C 11/00

\* cited by examiner

*Primary Examiner* — Charles D Hanson

(74) *Attorney, Agent, or Firm* — Fitch, Even, Tabin & Flannery LLP

(57) **CLAIM**

The ornamental design for a kickstand, as shown and described.

**DESCRIPTION**

FIG. 1 is a rear perspective view of a kickstand showing our new design;  
FIG. 2 is a front perspective view thereof;  
FIG. 3 is a rear elevation view thereof;  
FIG. 4 is a front elevation view thereof;  
FIG. 5 is a left side elevation view thereof;  
FIG. 6 is a right side elevation view thereof;  
FIG. 7 is a top plan view thereof; and,  
FIG. 8 is a bottom plan view thereof.  
The broken lines in FIGS. 1-8 depict unclaimed portions of the kickstand and form no part of the claimed design.

**1 Claim, 7 Drawing Sheets**

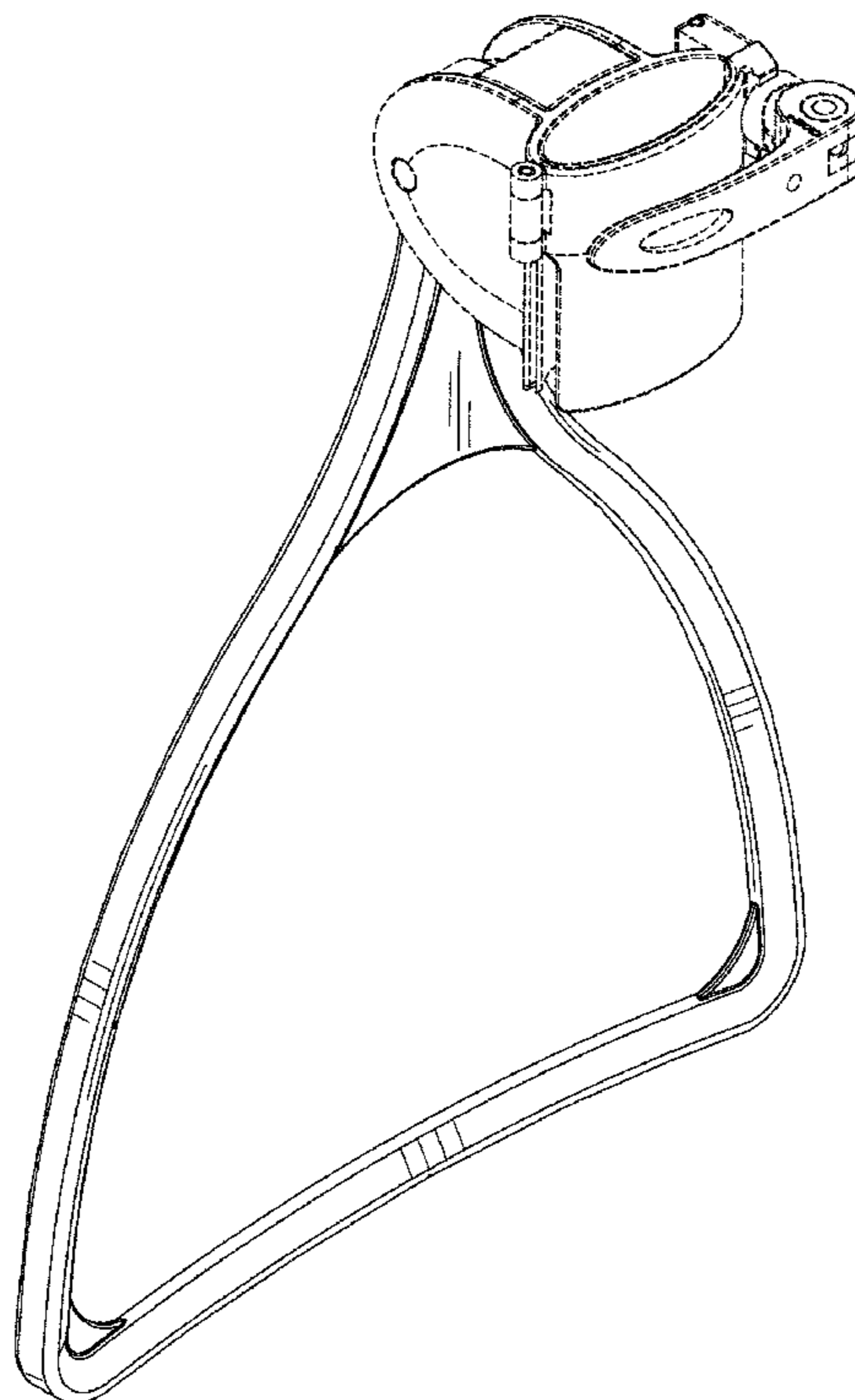

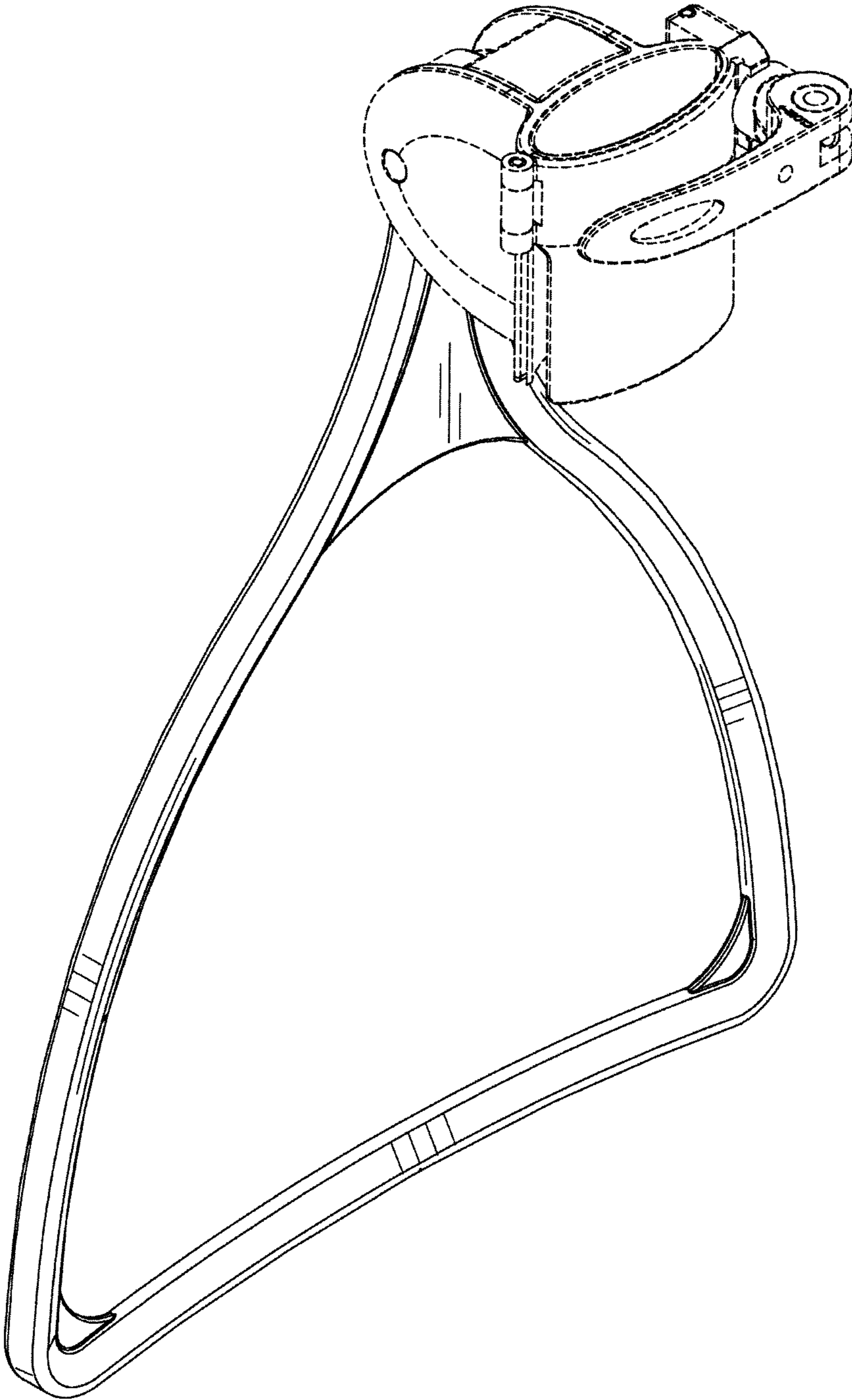

FIG. 1

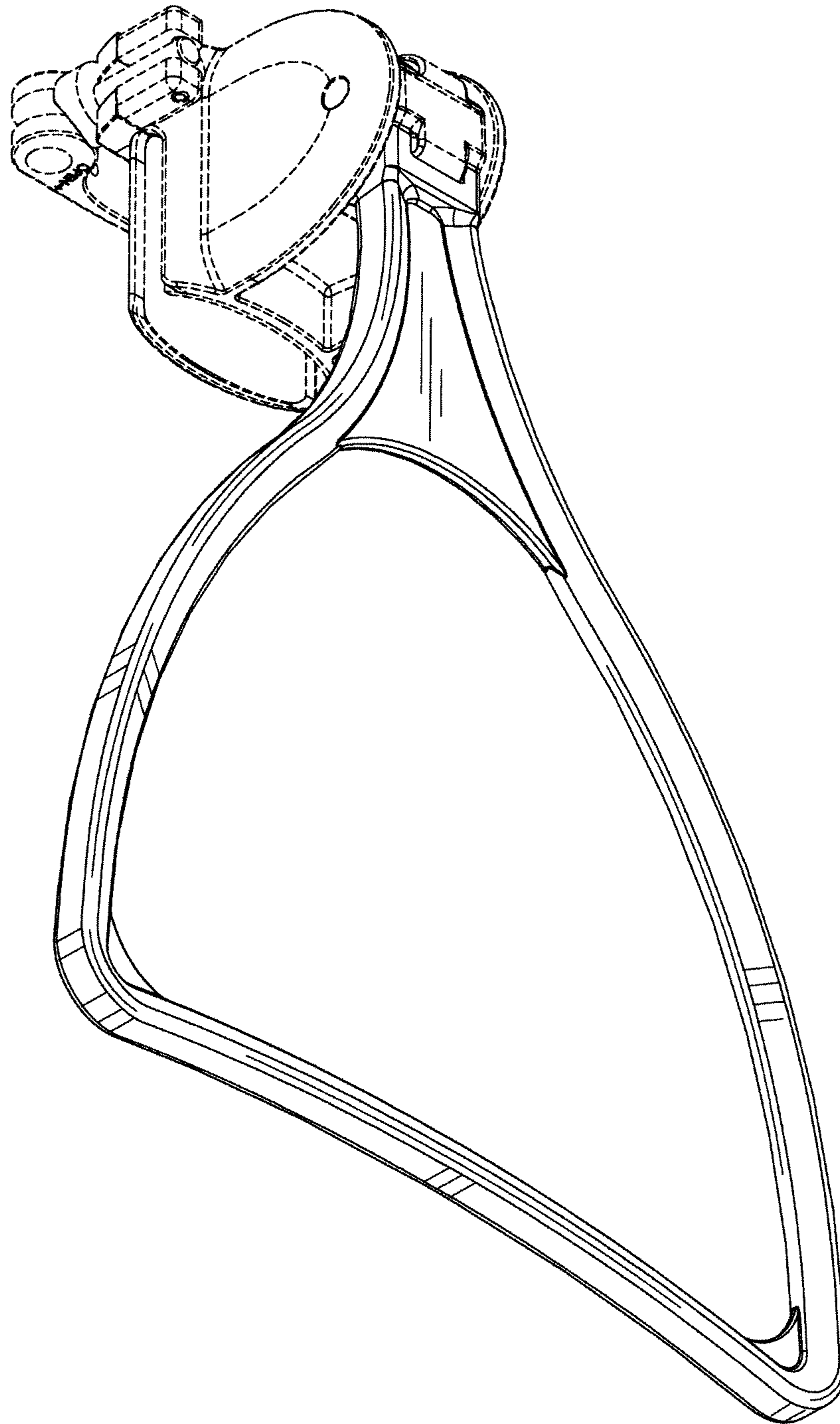

FIG. 2

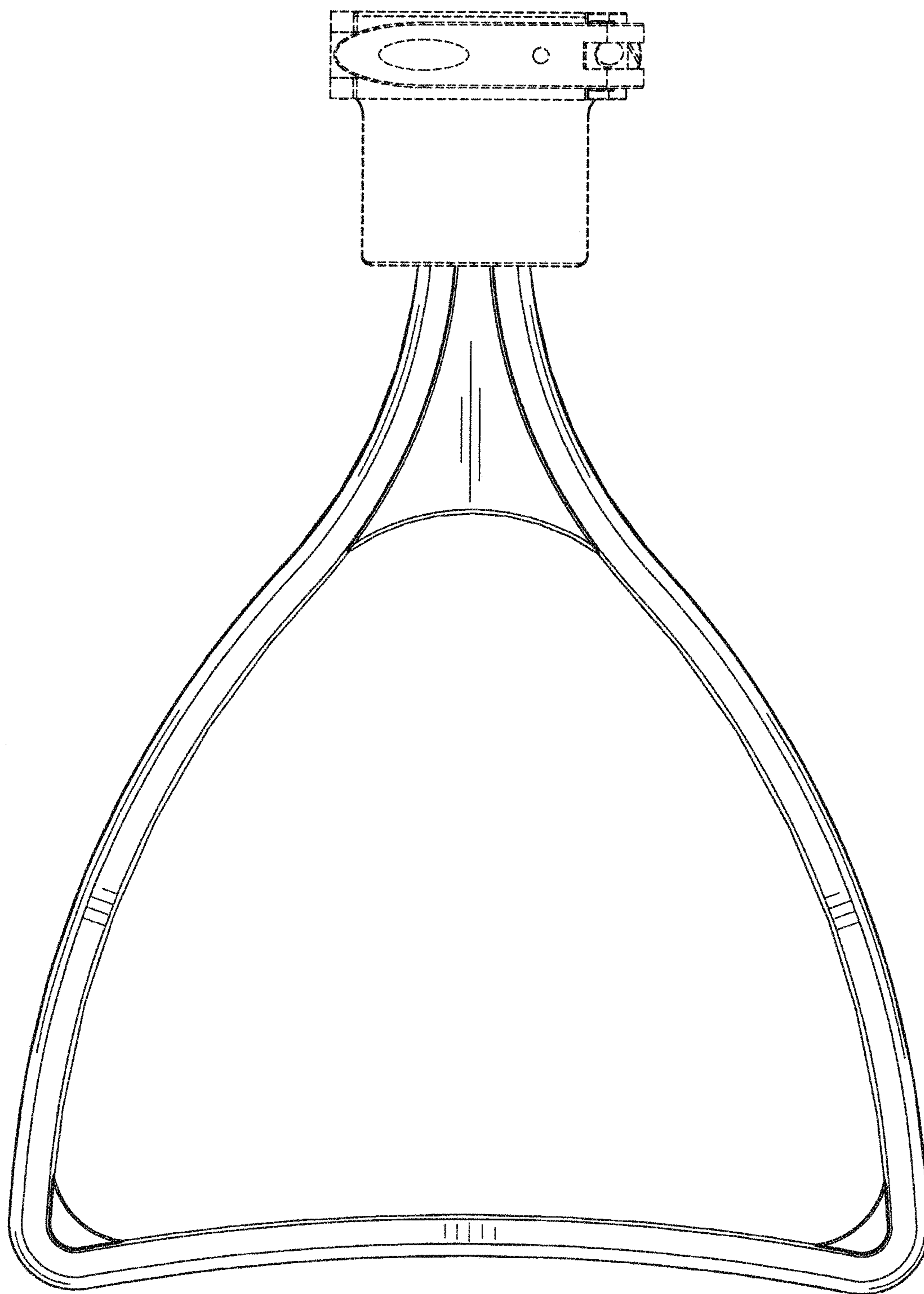

FIG. 3

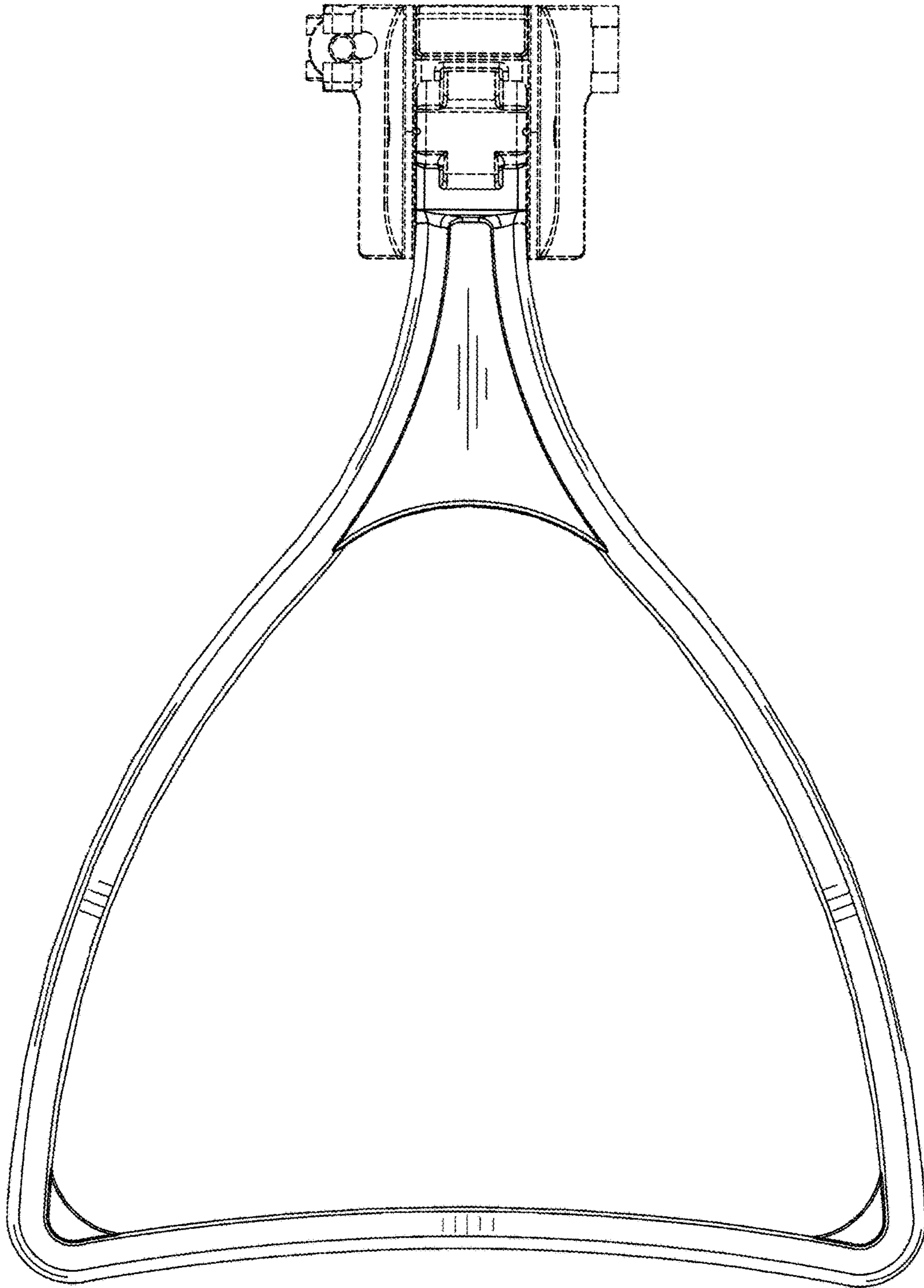

FIG. 4

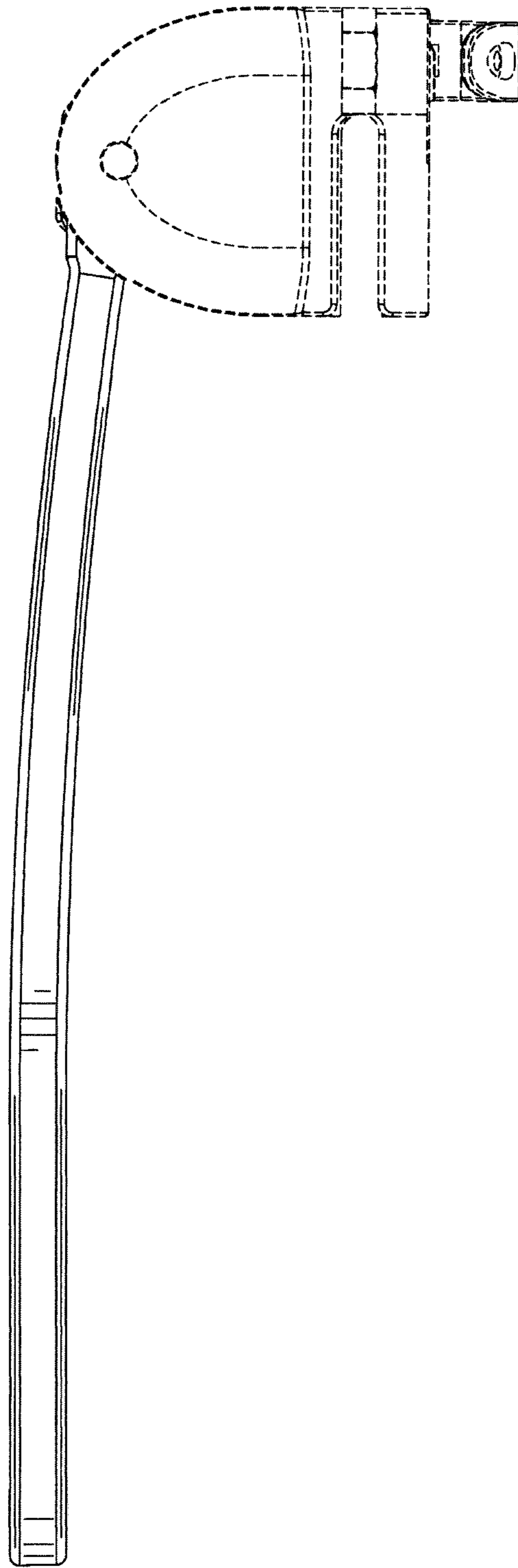

FIG. 5

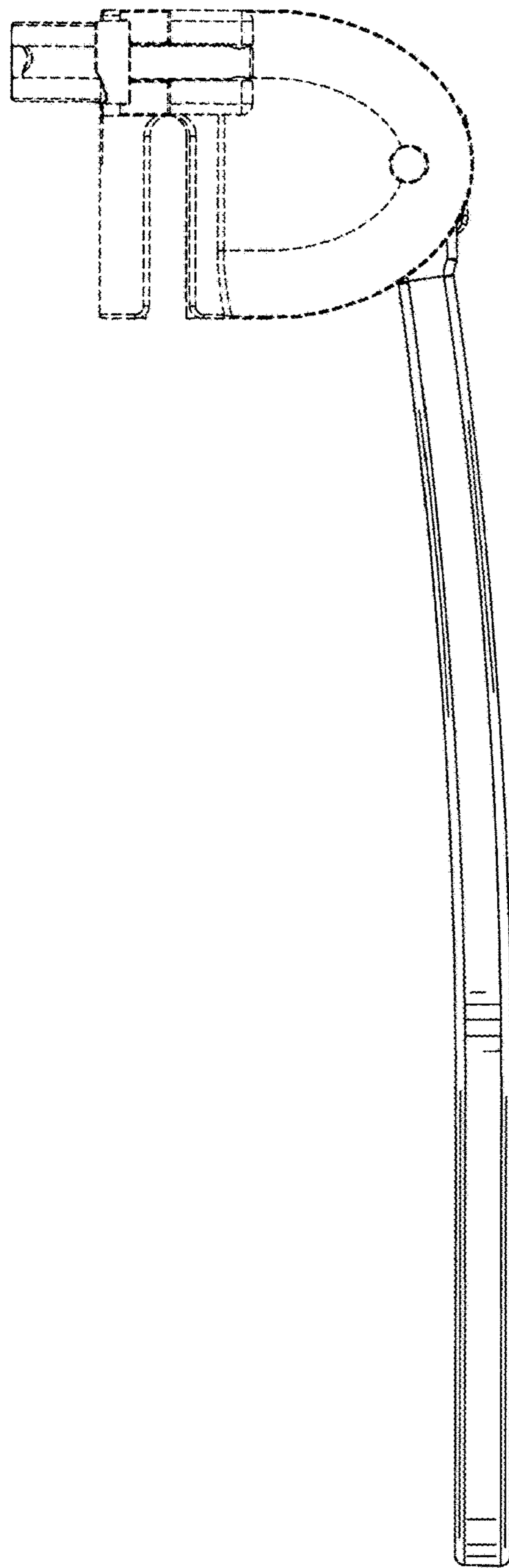

FIG. 6

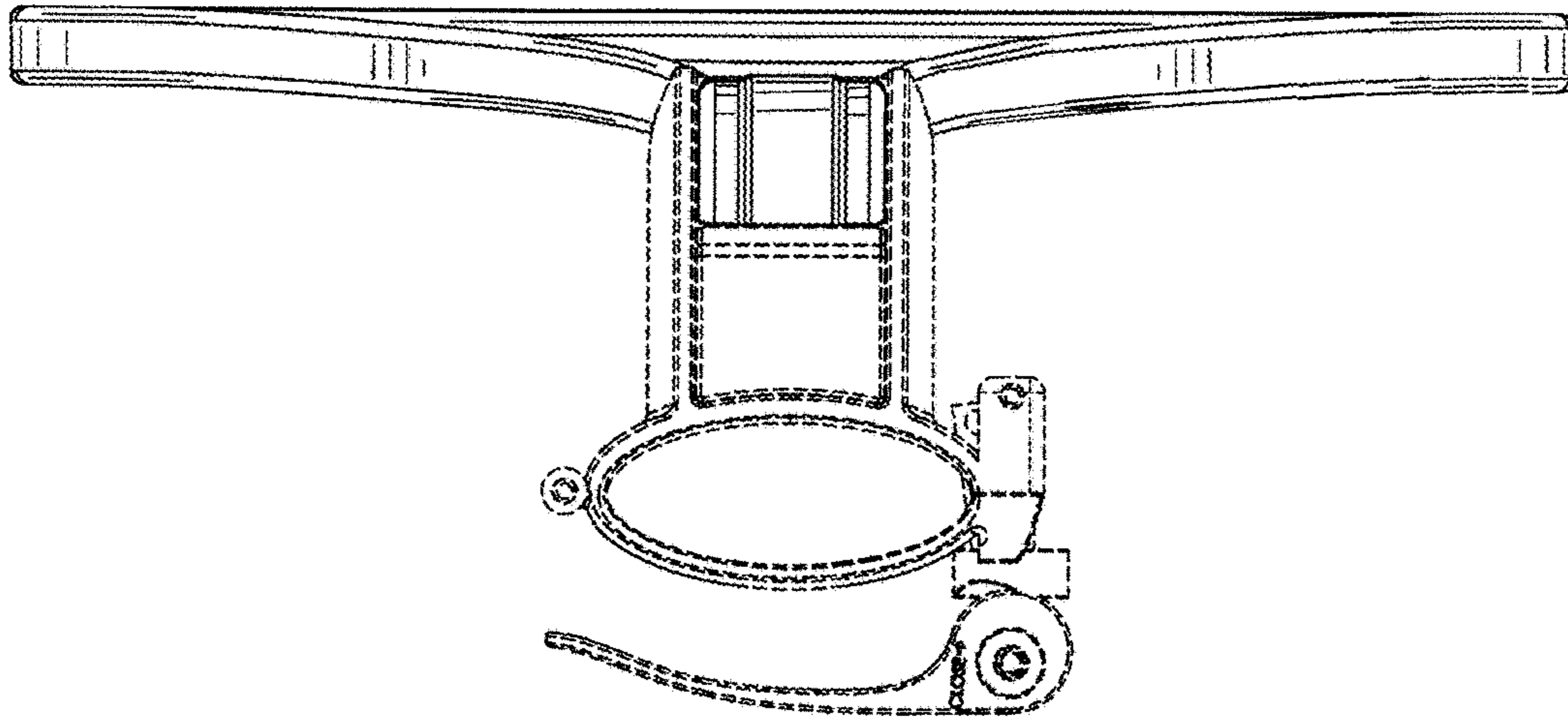

FIG. 7

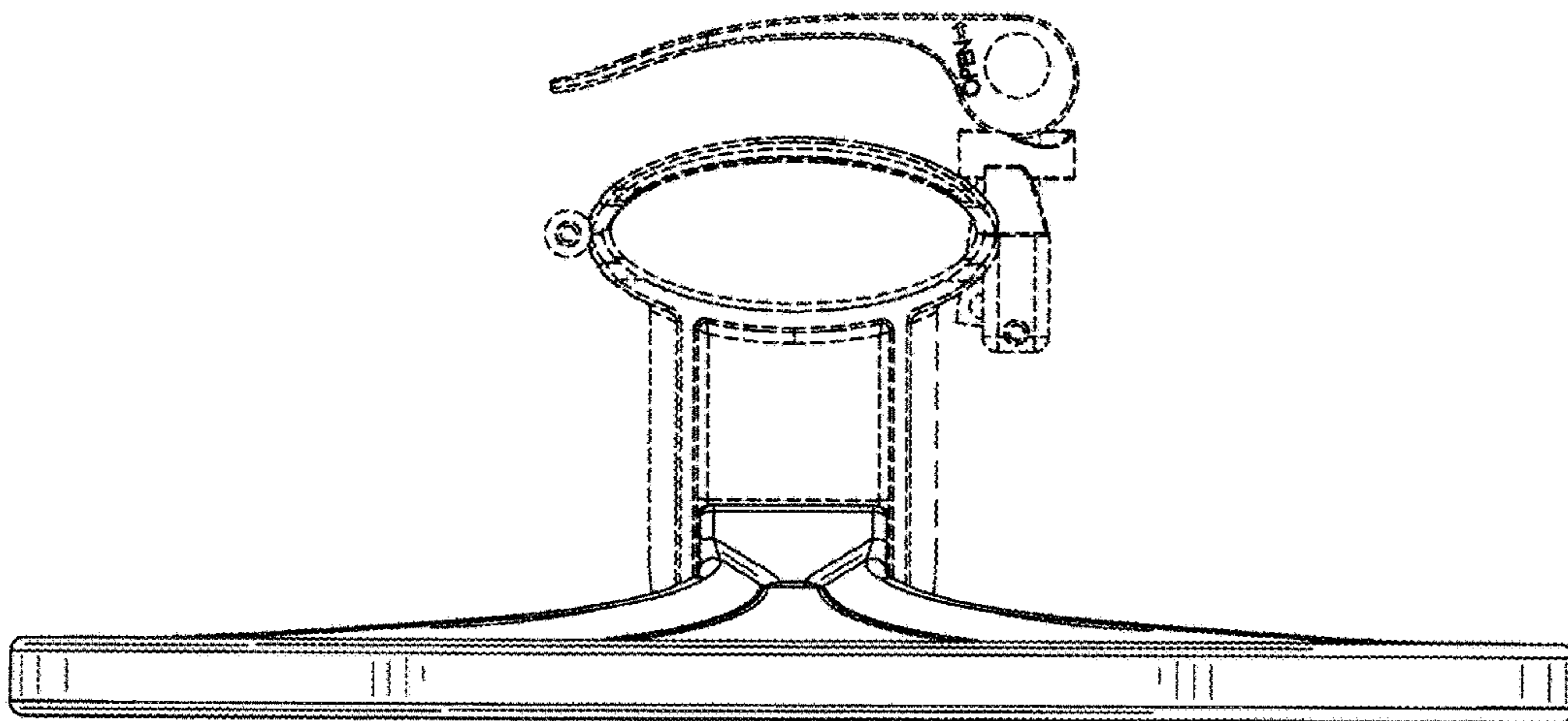

FIG. 8