



US00D867900S

(12) **United States Design Patent** (10) **Patent No.:** **US D867,900 S**
Thompson et al. (45) **Date of Patent:** **** Nov. 26, 2019**

(54) **CARRIER**
(71) Applicant: **Graphic Packaging International, LLC, Atlanta, GA (US)**
(72) Inventors: **Jon Thompson, Bristol (GB); Steve M. Gould, Bristol (GB)**

2,872,036 A 2/1959 Forrer
2,874,869 A 2/1959 Hennessey
2,888,135 A 5/1959 Reynolds
RE24,667 E 7/1959 Fielding
2,922,561 A 1/1960 Curri van
2,928,541 A 3/1960 Fielding
(Continued)

(73) Assignee: **Graphic Packaging International, LLC, Atlanta, GA (US)**

FOREIGN PATENT DOCUMENTS

BE 671762 3/1966
CA 877792 8/1971
(Continued)

(**) Term: **15 Years**

(21) Appl. No.: **29/638,862**

OTHER PUBLICATIONS

(22) Filed: **Mar. 1, 2018**

International Search Report and Written Opinion for PCT/US2019/012474 dated Apr. 30, 2019.

(51) **LOC (12) Cl.** **09-03**

(52) **U.S. Cl.**
USPC **D9/754; D9/432; D9/433**

Primary Examiner — Vy N Koenig
(74) *Attorney, Agent, or Firm* — Womble Bond Dickinson (US) LLP

(58) **Field of Classification Search**
USPC D9/414–423, 430–433, 454, 456, 457, D9/711, 713, 721–722, 738–740, D9/751–755; D20/10, 22
CPC ... B65D 5/00; B65D 5/02; B65D 5/18; B65D 5/20

(57) **CLAIM**

The ornamental design for a carrier, as shown and described.

See application file for complete search history.

DESCRIPTION

(56) **References Cited**

FIG. 1 is a perspective view of a carrier showing our new design.
FIG. 2 is a left elevation view of the carrier of FIG. 1, the right elevation view is a mirror image.
FIG. 3 is a front elevation view of the carrier of FIG. 1, the rear elevation view is a mirror image.
FIG. 4 is a top plan view of the carrier of FIG. 1.
FIG. 5 is a bottom plan view of the carrier of FIG. 1; and, FIG. 6 is a plan view of the carrier of FIG. 1 shown in an unfolded configuration.
All evenly-spaced broken lines depict environmental subject matter only and do no form part of the claimed design.

U.S. PATENT DOCUMENTS

1,253,193 A 1/1918 Hill
2,375,631 A 5/1945 DeVillard
2,383,183 A 8/1945 Fischer
2,594,376 A 4/1952 Arneson
2,702,144 A 2/1955 Forrer
2,718,301 A 9/1955 Palmer
2,785,847 A 3/1957 Forrer
2,797,856 A 7/1957 Jaeschke
2,810,506 A 10/1957 Kessler
2,811,250 A 10/1957 Arneson
2,849,111 A 8/1958 Fielding
2,868,433 A 1/1959 Anderson, Jr.

1 Claim, 6 Drawing Sheets

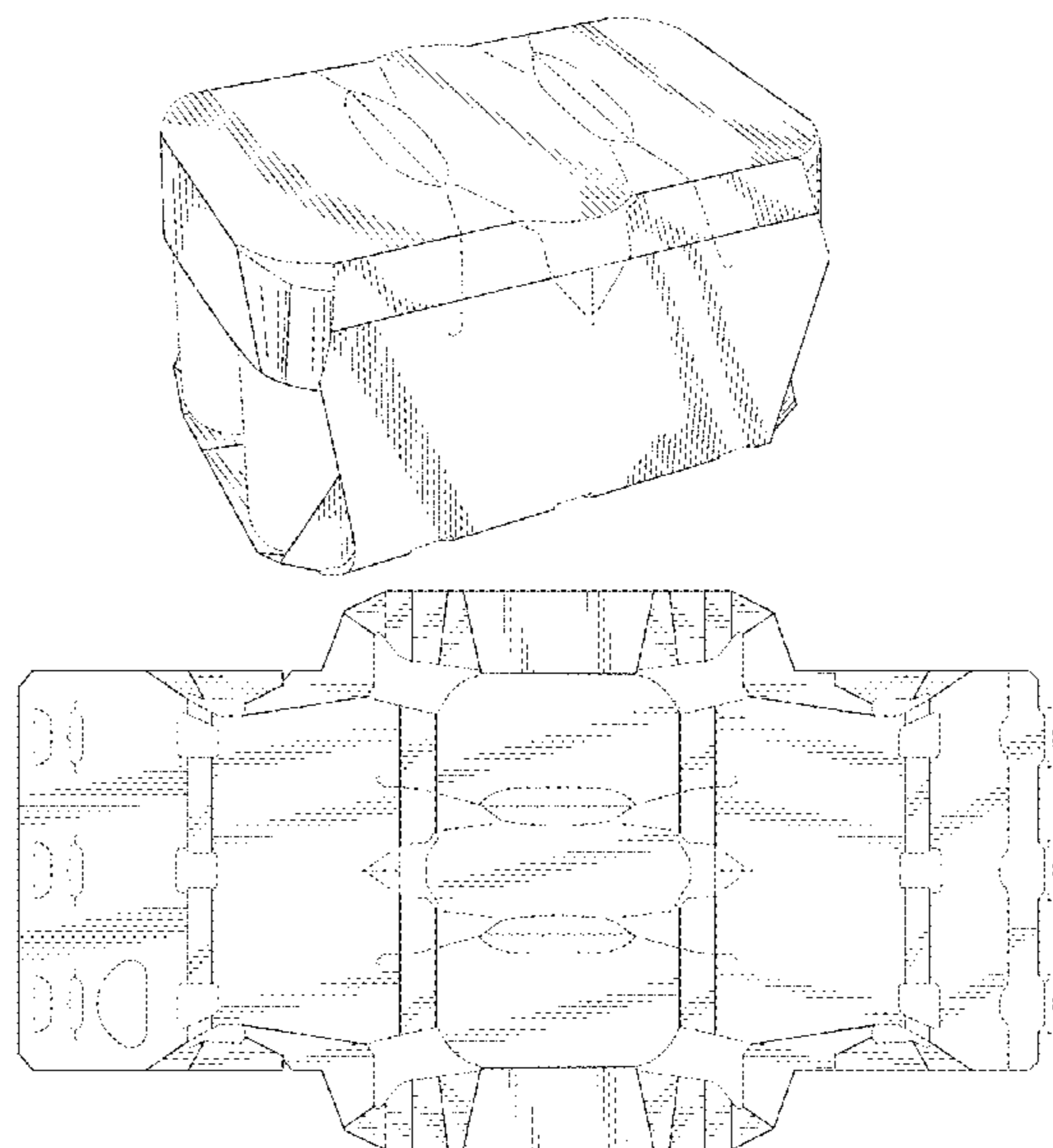

(56)

References Cited

U.S. PATENT DOCUMENTS

2,929,497 A	3/1960	De Million-Czarnecki	4,378,905 A	4/1983	Roccaforte
2,955,739 A	10/1960	Collura	4,382,505 A	5/1983	Sutherland
3,112,856 A	12/1963	MacIntosh et al.	4,394,903 A	7/1983	Bakx
3,127,720 A	4/1964	Gentry et al.	4,405,078 A	9/1983	Dutcher
3,128,010 A	4/1964	Forrer	4,421,232 A	12/1983	Konaka
3,156,404 A	11/1964	Wood	4,424,901 A	1/1984	Lanier
3,178,242 A	4/1965	Ellis	4,440,340 A	4/1984	Bakx
3,194,476 A	7/1965	Weiss	4,470,503 A	9/1984	Stone
3,204,815 A	9/1965	Weiss	4,478,334 A	10/1984	Graser
3,229,892 A	1/1966	Weiss	4,498,619 A	2/1985	Roccaforte
3,237,762 A	3/1966	Wood	4,508,258 A	4/1985	Graser
3,252,649 A	5/1966	Graser et al.	4,533,047 A	8/1985	Calvert
3,257,066 A	6/1966	Williams	4,538,759 A	9/1985	Dutcher
3,269,531 A	8/1966	Weiss	4,545,485 A	10/1985	Oliff
3,278,075 A	10/1966	Weiss	4,546,914 A	10/1985	Roccaforte
3,292,843 A	12/1966	Chidsey, Jr. et al.	4,558,816 A	12/1985	Wood
3,300,115 A	1/1967	Schauer	4,566,593 A	1/1986	Muller
3,306,519 A	2/1967	Wood	4,577,799 A	3/1986	Oliff
3,309,005 A	3/1967	Pilger	4,582,199 A	4/1986	Schuster
3,334,767 A	8/1967	Cornelius et al.	4,588,084 A	5/1986	Holley, Jr.
3,339,723 A	9/1967	Wood	4,611,754 A	9/1986	Sutherland
3,343,660 A	9/1967	Bailey	4,637,515 A	1/1987	Wilson
3,353,709 A	11/1967	Lawrence	4,653,686 A	3/1987	Wood
3,355,012 A	11/1967	Weiss	4,681,217 A	7/1987	Hernandez
3,356,279 A	12/1967	Root	4,681,252 A	7/1987	Doerr
3,367,557 A	2/1968	Farquhar	4,684,059 A	8/1987	Rusnock
3,371,846 A	3/1968	Detzel	4,706,876 A	11/1987	Wilson
3,373,867 A	3/1968	Wood	4,708,284 A	11/1987	Sutherland et al.
3,375,968 A	4/1968	Weiss	4,728,025 A	3/1988	Oliff
3,381,881 A	5/1968	Granz et al.	4,728,026 A	3/1988	Schuster
3,429,496 A	2/1969	Hickin	4,747,487 A	5/1988	Wood
3,447,672 A	6/1969	Bailey	4,747,534 A	5/1988	Marie
3,462,011 A	8/1969	Farquhar	4,784,266 A	11/1988	Chaussadas
3,517,858 A	6/1970	Farquhar	4,784,316 A	11/1988	Crouch
3,517,876 A	6/1970	Stout	4,785,991 A	11/1988	Schuster
3,554,402 A	1/1971	Lock	4,802,583 A	2/1989	Calvert
3,593,849 A	7/1971	Helms	4,804,089 A	2/1989	Wilson
3,635,452 A	1/1972	Helms	4,811,894 A	3/1989	Schuster
3,655,117 A	4/1972	Weiss	4,815,599 A	3/1989	Schuster
3,669,342 A	6/1972	Funkhouse	4,830,267 A	5/1989	Wilson
3,669,343 A	6/1972	Howard	4,836,375 A	6/1989	Schuster
3,715,029 A	2/1973	Wood	4,838,479 A	6/1989	Wood
3,747,835 A	7/1973	Graser	4,844,328 A	7/1989	Cooper
3,767,042 A	10/1973	Ganz	4,860,943 A	8/1989	Cooper
3,828,926 A	8/1974	Rossi	4,875,585 A	10/1989	Kadleck
3,886,901 A	6/1975	Zeitler	4,875,586 A	10/1989	Chaussadas
3,904,036 A	9/1975	Forrer	RE33,110 E	11/1989	Wood
3,933,303 A	1/1976	Kirby, Jr.	4,878,612 A	11/1989	Schuster
3,963,121 A	6/1976	Kipp	4,901,849 A	2/1990	Wilson
3,994,432 A	11/1976	Kirby, Jr.	4,919,266 A	4/1990	McIntosh, Jr. et al.
4,004,500 A	1/1977	Wood	4,958,734 A	9/1990	Wood
4,010,593 A	3/1977	Graham	4,966,324 A	10/1990	Steel
4,029,204 A	6/1977	Manizza	4,972,991 A	11/1990	Schuster
4,032,053 A	6/1977	Wilson	4,974,771 A	12/1990	Lavery
4,034,852 A	7/1977	Forrer	4,981,253 A	1/1991	Quaintance
4,036,423 A	7/1977	Gordon	5,000,313 A	3/1991	Oliff
4,096,985 A	6/1978	Wood	5,002,186 A	3/1991	Cooper
4,101,069 A	7/1978	Wood	5,020,337 A	6/1991	Krieg
4,111,306 A	9/1978	Roccaforte	5,042,660 A	8/1991	Carver
4,200,220 A	4/1980	Ganz	5,060,792 A	10/1991	Oliff
4,202,446 A	5/1980	Sutherland	5,060,804 A	10/1991	Beales et al.
4,215,781 A	8/1980	Humphries et al.	5,072,876 A	12/1991	Wilson
4,216,861 A	8/1980	Oliff	5,094,347 A	3/1992	Schuster
4,222,485 A	9/1980	Focke	5,094,359 A	3/1992	DeMars
4,295,562 A	10/1981	Wood	5,106,014 A	4/1992	Miller
4,314,634 A	2/1982	Stone	5,108,030 A	4/1992	Schuster
4,318,474 A	3/1982	Hasegawa	5,119,985 A	6/1992	Dawson
4,327,829 A	5/1982	Hughes	5,131,588 A	7/1992	Oliff
4,328,893 A	5/1982	Oliff et al.	5,180,100 A	1/1993	Shimizu
4,328,923 A	5/1982	Graser	5,195,676 A	3/1993	LeBras
4,331,289 A	5/1982	Killy	5,197,598 A	3/1993	Stout
4,339,070 A	7/1982	Davies	5,221,041 A	6/1993	Stout
4,355,717 A	10/1982	Oliff	5,222,658 A	6/1993	DeMaio
4,364,509 A	12/1982	Holley, Jr.	5,234,102 A	8/1993	Schuster
4,375,258 A	3/1983	Crayne	5,246,112 A	9/1993	Stout
			5,246,122 A	9/1993	Schick et al.
			5,284,294 A	2/1994	Floyd
			5,292,058 A	3/1994	Zoss
			5,292,059 A	3/1994	Oliff

(56)

References Cited

U.S. PATENT DOCUMENTS

5,297,673 A	3/1994	Sutherland	5,924,628 A	7/1999	Oliff
5,297,725 A	3/1994	Sutherland	5,931,300 A	8/1999	Sutherland
5,303,863 A	4/1994	Arasim	5,937,620 A	8/1999	Chalendar
5,307,932 A	5/1994	Stout	5,941,389 A	8/1999	Gomes
5,307,986 A	5/1994	Schuster	5,941,453 A	8/1999	Oliff
5,310,050 A	5/1994	Sutherland	5,943,847 A	8/1999	Chalendar
5,311,984 A	5/1994	Harris	5,947,367 A	9/1999	Miller
5,320,277 A	6/1994	Stout	5,957,289 A	9/1999	Negelen
5,328,080 A	7/1994	Holley, Jr.	D415,423 S *	10/1999	Miller D9/431
5,333,734 A	8/1994	Stout	5,975,286 A	11/1999	Oliff
D350,480 S	9/1994	Sutherland	5,992,733 A	11/1999	Gomes
5,351,878 A	10/1994	Cooper	5,996,883 A	12/1999	Bates
5,379,944 A	1/1995	Stout	6,019,220 A	2/2000	Sutherland
5,381,891 A	1/1995	Harris	6,019,276 A	2/2000	Auclair
5,385,234 A	1/1995	Stout	6,021,898 A	2/2000	Sutherland
5,395,043 A	3/1995	Bacques et al.	6,021,899 A	2/2000	Sutherland
5,395,044 A	3/1995	Stout	6,065,590 A	5/2000	Spivey
5,398,870 A	3/1995	Bienaime	6,085,969 A	7/2000	Burgoyne
5,421,458 A	6/1995	Campbell	6,105,853 A	8/2000	Lamare
5,427,241 A	6/1995	Sutherland	6,105,854 A	8/2000	Spivey
5,437,363 A	8/1995	Gungner	6,109,438 A	8/2000	Sutherland
5,443,203 A	8/1995	Sutherland	6,126,066 A	10/2000	Peterson
5,458,234 A	10/1995	Harris	6,129,266 A	10/2000	Oliff
5,472,090 A	12/1995	Sutherland	6,131,803 A	10/2000	Oliff
5,472,138 A	12/1995	Ingram	6,155,480 A	12/2000	Botsford
5,480,091 A	1/1996	Stout	6,158,586 A	12/2000	Muller
5,482,203 A	1/1996	Stout	6,164,526 A	12/2000	Dalvey
5,485,915 A	1/1996	Harris	6,170,741 B1	1/2001	Skolik
5,495,727 A	3/1996	Strong	6,173,889 B1	1/2001	Sutherland
5,505,372 A	4/1996	Edson	6,227,367 B1	5/2001	Harrelson
5,520,283 A	5/1996	Sutherland	6,237,839 B1	5/2001	Brown
5,524,756 A	6/1996	Sutherland	6,250,542 B1	6/2001	Negelen
5,542,536 A	8/1996	Sutherland	6,260,755 B1	7/2001	Bates
5,549,197 A	8/1996	Sutherland	6,273,330 B1	8/2001	Oliff
5,551,556 A	9/1996	Sutherland	6,283,293 B1	9/2001	Lingamfelter
5,558,212 A	9/1996	Sutherland	6,289,651 B1	9/2001	Le Bras
5,558,213 A	9/1996	Sutherland	6,302,320 B1	10/2001	Stout
5,582,343 A	12/1996	Dalvey	6,315,123 B1	11/2001	Ikeda
5,588,586 A	12/1996	Negelen	6,378,697 B1	4/2002	Sutherland et al.
5,593,027 A	1/1997	Sutherland	6,378,765 B1	4/2002	Sutherland
5,595,291 A	1/1997	Negelen	6,415,917 B1	7/2002	Marco
5,597,071 A	1/1997	Sutherland	6,425,520 B1	7/2002	Peterson
5,605,228 A	2/1997	Baxter	6,484,903 B2	11/2002	Spivey et al.
5,609,251 A	3/1997	Harris	6,523,739 B2	2/2003	Heeley
5,638,956 A	6/1997	Sutherland	6,527,108 B1	3/2003	Blin et al.
5,639,017 A	6/1997	Fogle	6,536,656 B2	3/2003	Auclair
5,647,483 A	7/1997	Harris	6,550,616 B2	4/2003	LeBras
5,653,341 A	8/1997	Miret	6,631,803 B2	10/2003	Rhodes
5,657,864 A	8/1997	Harrelson	6,695,137 B2	2/2004	Jones
5,664,401 A	9/1997	Portrait	6,715,639 B2	4/2004	Spivey
5,669,500 A	9/1997	Sutherland	6,736,260 B2	5/2004	Gomes et al.
5,671,845 A	9/1997	Harris	6,758,337 B2	7/2004	Chargueraud
5,682,995 A	11/1997	Sutherland	6,766,940 B2	7/2004	Negelen
5,692,614 A	12/1997	Harris	6,789,673 B2	9/2004	Lingamfelter
5,699,957 A	12/1997	Blin	6,811,525 B2	11/2004	Culpepper
5,704,470 A	1/1998	Sutherland	6,848,573 B2	2/2005	Gould
5,704,542 A	1/1998	Harrelson	6,866,185 B2	3/2005	Harrelson
5,738,273 A	4/1998	Auclair	6,877,600 B2	4/2005	Sutherland
D395,007 S *	6/1998	Miller D9/431	6,896,130 B2	5/2005	Theelen
D395,601 S *	6/1998	Miller D9/431	6,905,066 B2	6/2005	Holley, Jr.
5,765,685 A	6/1998	Roosa	6,926,193 B2	8/2005	Smalley
5,778,630 A	7/1998	Portrait	6,942,140 B2	9/2005	Merzeau
5,782,343 A	7/1998	Harrelson	6,948,651 B2	9/2005	Ikeda
5,794,778 A	8/1998	Harris	6,968,992 B2	11/2005	Schuster
5,796,778 A	8/1998	Kurker	6,981,631 B2	1/2006	Fogle et al.
5,819,920 A	10/1998	Sutherland	6,988,617 B2	1/2006	Gomes et al.
5,826,782 A	10/1998	Stout	7,007,800 B2	3/2006	LeBras
5,826,783 A	10/1998	Stout	7,007,836 B2	3/2006	Smalley
5,853,088 A	12/1998	Saulas	7,025,197 B2	4/2006	Sutherland
5,855,318 A	1/1999	Baxter	7,093,713 B2	8/2006	Sutherland
5,868,308 A	2/1999	Briand	7,159,759 B2	1/2007	Sutherland
5,873,515 A	2/1999	Dunn	7,175,020 B2	2/2007	Sutherland et al.
5,878,946 A	3/1999	Frerot	7,222,777 B2	5/2007	Garnier
5,906,313 A	5/1999	Oliff	7,273,161 B2	9/2007	Fogle
5,915,546 A	6/1999	Harrelson	7,380,701 B2	6/2008	Fogle et al.
			7,427,010 B2	9/2008	Sutherland
			7,448,492 B2	11/2008	Sutherland
			7,472,791 B2	1/2009	Spivey, Sr.
			7,644,817 B2	1/2010	Sutherland

US D867,900 S

(56)

References Cited

U.S. PATENT DOCUMENTS

7,677,387	B2	3/2010	Brand et al.
7,743,968	B2	6/2010	Theelen
7,748,603	B2	7/2010	Fogle
7,757,933	B2	7/2010	Dunn
7,762,395	B2	7/2010	Sutherland et al.
7,762,397	B2	7/2010	Coltri-Johnson et al.
7,793,779	B2	9/2010	Spivey, Sr.
7,806,314	B2	10/2010	Sutherland
7,832,183	B2	11/2010	Jacob et al.
7,900,815	B2	3/2011	Shmagin
7,913,844	B2	3/2011	Spivey, Sr.
8,083,061	B2	12/2011	Fogel et al.
8,317,082	B2	11/2012	May et al.
8,997,986	B2	4/2015	Spivey, Sr.
D742,759	S *	11/2015	Ryan D9/702
D743,811	S *	11/2015	Lebeau D9/711
9,199,774	B2	12/2015	Smalley et al.
2003/0000182	A1	1/2003	Portrait et al.
2003/0080180	A1	5/2003	Holley, Jr. et al.
2003/0132130	A1	7/2003	Bras
2003/0213263	A1	11/2003	Woog
2004/0000582	A1	1/2004	Sutherland
2004/0011674	A1	1/2004	Theelen
2004/0069659	A1	4/2004	Sutherland
2004/0074854	A1	4/2004	Lin
2004/0089671	A1	5/2004	Miller
2004/0099542	A1	5/2004	Sutherland
2004/0188277	A1	9/2004	Auclair
2004/0188301	A1	9/2004	Gomes
2004/0243277	A1	12/2004	Bonnain et al.
2004/0254666	A1	12/2004	Bonnain et al.
2005/0001020	A1	1/2005	Gamier
2005/0056658	A1	3/2005	Spivey
2005/0103652	A1	5/2005	Wilkins
2005/0167290	A1	8/2005	Sutherland
2005/0167478	A1	8/2005	Holley
2005/0178791	A1	8/2005	Miller
2005/0194430	A1	9/2005	Auclair et al.
2006/0157545	A1	7/2006	Auclair
2006/0169755	A1	8/2006	Spivey
2006/0191811	A1	8/2006	Fogle et al.
2006/0237520	A1	10/2006	Cargile, Jr.
2006/0255108	A1	11/2006	Shmagin
2006/0273143	A1	12/2006	Finch
2007/0017829	A1	1/2007	Sutherland
2007/0017962	A1	1/2007	Russ
2007/0029371	A1	2/2007	Theelen
2007/0039846	A1	2/2007	Spivey
2007/0051781	A1	3/2007	Holley
2007/0108261	A1	5/2007	Schuster
2007/0114151	A1	5/2007	Auclair
2007/0164091	A1	7/2007	Fogle
2007/0181658	A1	8/2007	Sutherland
2007/0205255	A1	9/2007	Dunn
2007/0241017	A1	10/2007	Sutherland et al.
2007/0295789	A1	12/2007	Ho Fung
2008/0067223	A1	3/2008	Jego
2008/0073420	A1	3/2008	Walling
2009/0236408	A1	9/2009	Spivey
2010/0072267	A1	3/2010	May
2010/0213249	A1	8/2010	Requena
2011/0036902	A1	2/2011	Smalley

2012/0091190	A1	4/2012	Smalley et al.
2012/0267426	A1	10/2012	Hendricks et al.
2012/0285855	A1	11/2012	Spivey, Sr.

FOREIGN PATENT DOCUMENTS

CA	1 243 987	11/1988
CA	2 160 145	9/1995
CA	2 542 350	5/2005
DE	2 223 787	11/1973
DE	85 14 718.4	6/1985
DE	91 04 905.9	6/1991
DE	92 03 858.1	5/1992
DE	296 07 374	4/1996
DE	201 12 228	11/2002
DE	20 2004 018 649	4/2005
EP	0 242 992	11/1969
EP	0 159 172	10/1985
EP	0 233 078	8/1987
EP	0 473 266	3/1992
EP	0 509 749	10/1992
EP	0 459 658	12/1992
EP	0 520 411	12/1992
EP	0 388 238	6/1993
EP	1 612 157	1/2006
EP	2 149 506	2/2010
FR	1 438 035	1/1965
FR	2 698 074	5/1994
GB	1 101 345	1/1968
GB	1 172 430	11/1969
GB	2 202 825	10/1988
GB	2 209 515	5/1989
JP	4118199	10/1965
JP	61-2545	1/1986
JP	62-231736	10/1987
JP	5-112373	5/1993
JP	7-11566	2/1995
JP	H08-2551	1/1996
JP	10-338266	12/1998
JP	2003-200967	7/2003
JP	2003-252323	9/2003
JP	2004-533378	11/2004
WO	WO 96/27538	9/1996
WO	WO 97/27124	7/1997
WO	WO 98/09871	3/1998
WO	WO 99/11538	3/1999
WO	WO 99/28207	6/1999
WO	WO 00/78618	12/2000
WO	WO 00/78634	12/2000
WO	WO 01/66434	9/2001
WO	WO 02/102208	12/2002
WO	WO 03/004377	1/2003
WO	WO 03/008292	1/2003
WO	WO 03/037742	5/2003
WO	WO 2004/087507	10/2004
WO	WO 2005/042370	5/2005
WO	WO 2005/047134	5/2005
WO	WO 2005/080218	9/2005
WO	WO 2005/092735	10/2005
WO	WO 2005/123532	12/2005
WO	WO 2007/089282	8/2007
WO	WO 2007/126977	11/2007
WO	WO 2009/015320	1/2009
WO	WO 2009/117562	9/2009
WO	WO 2011/022378	2/2011

* cited by examiner

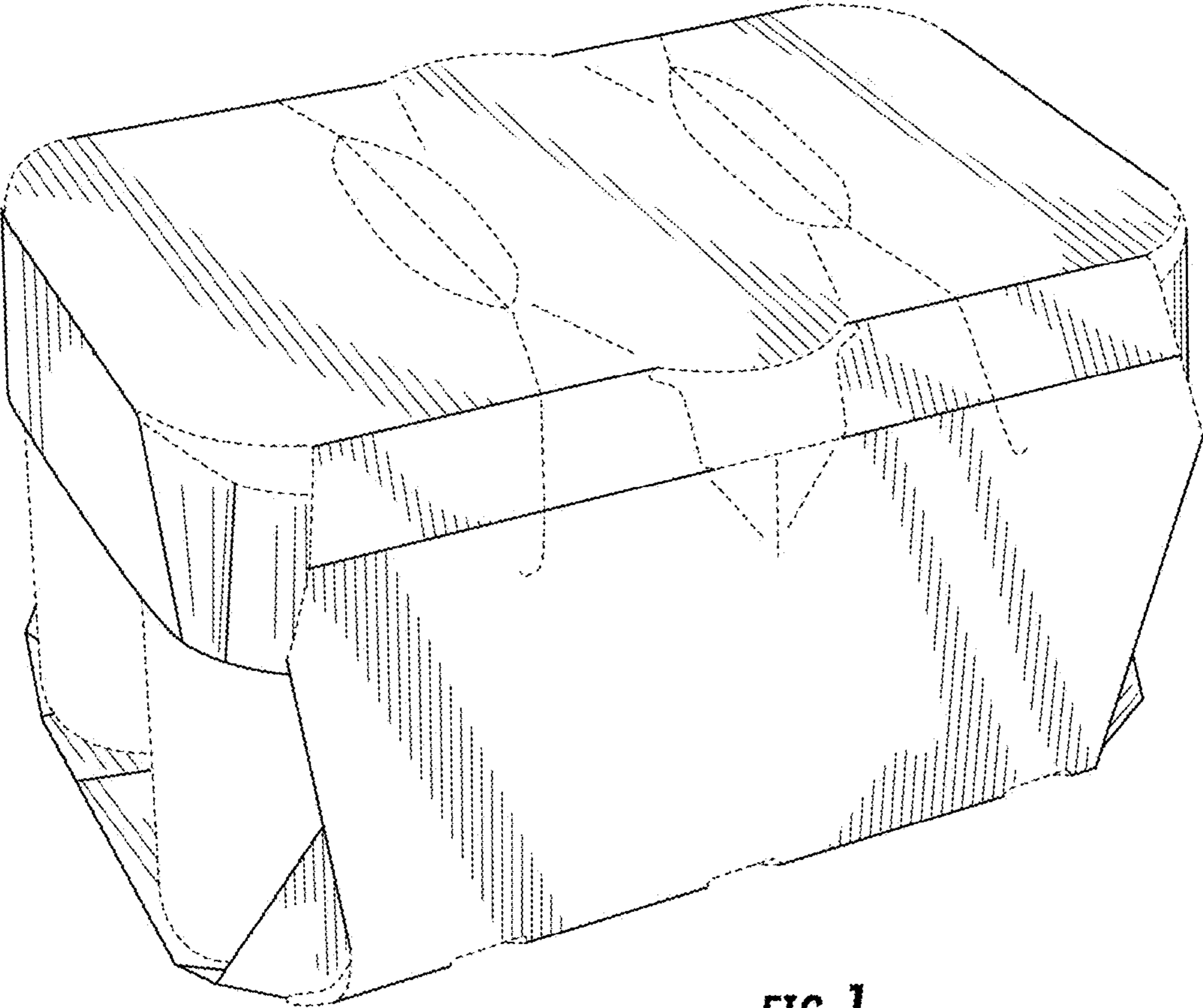

FIG. 1

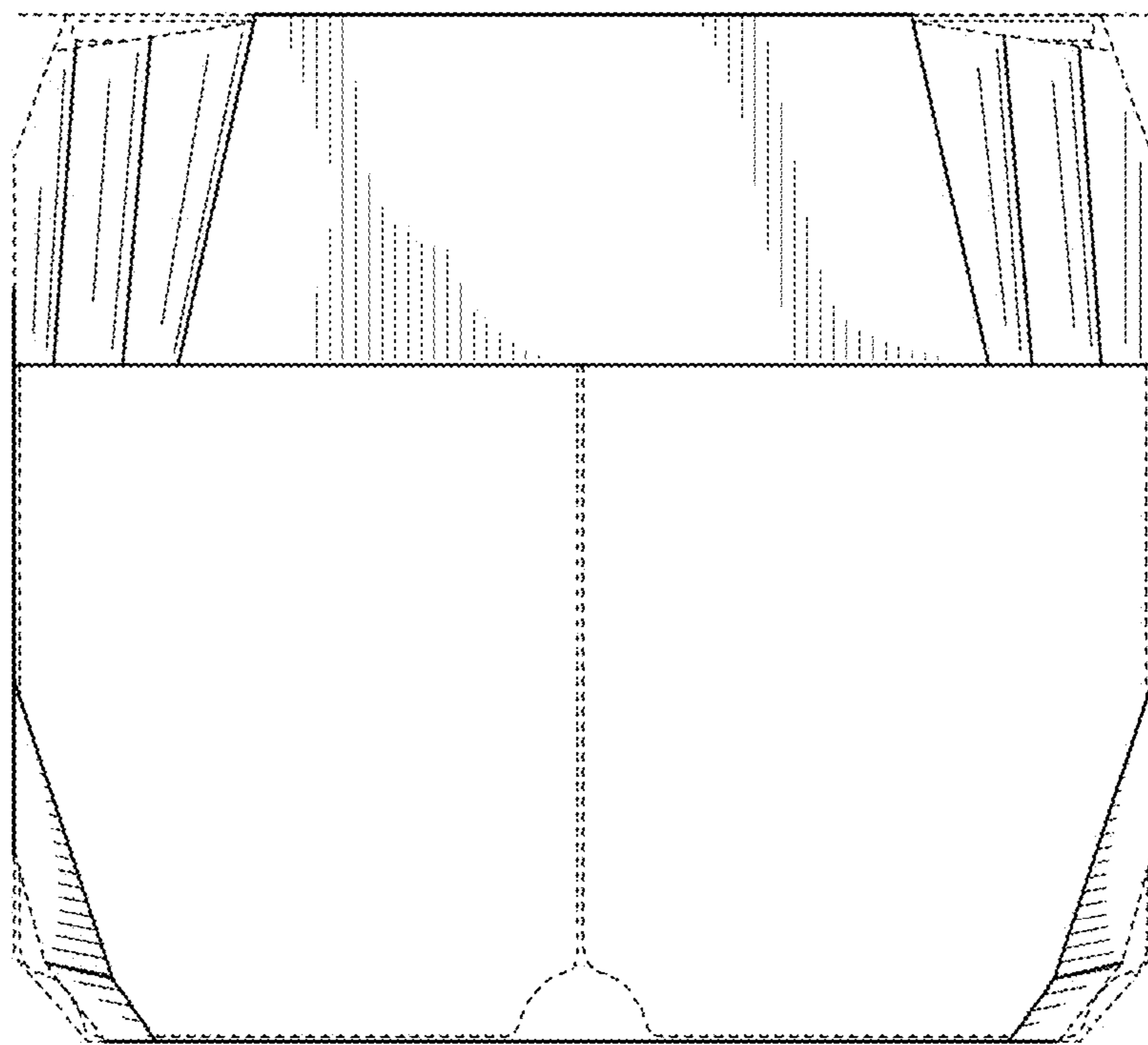

FIG. 2

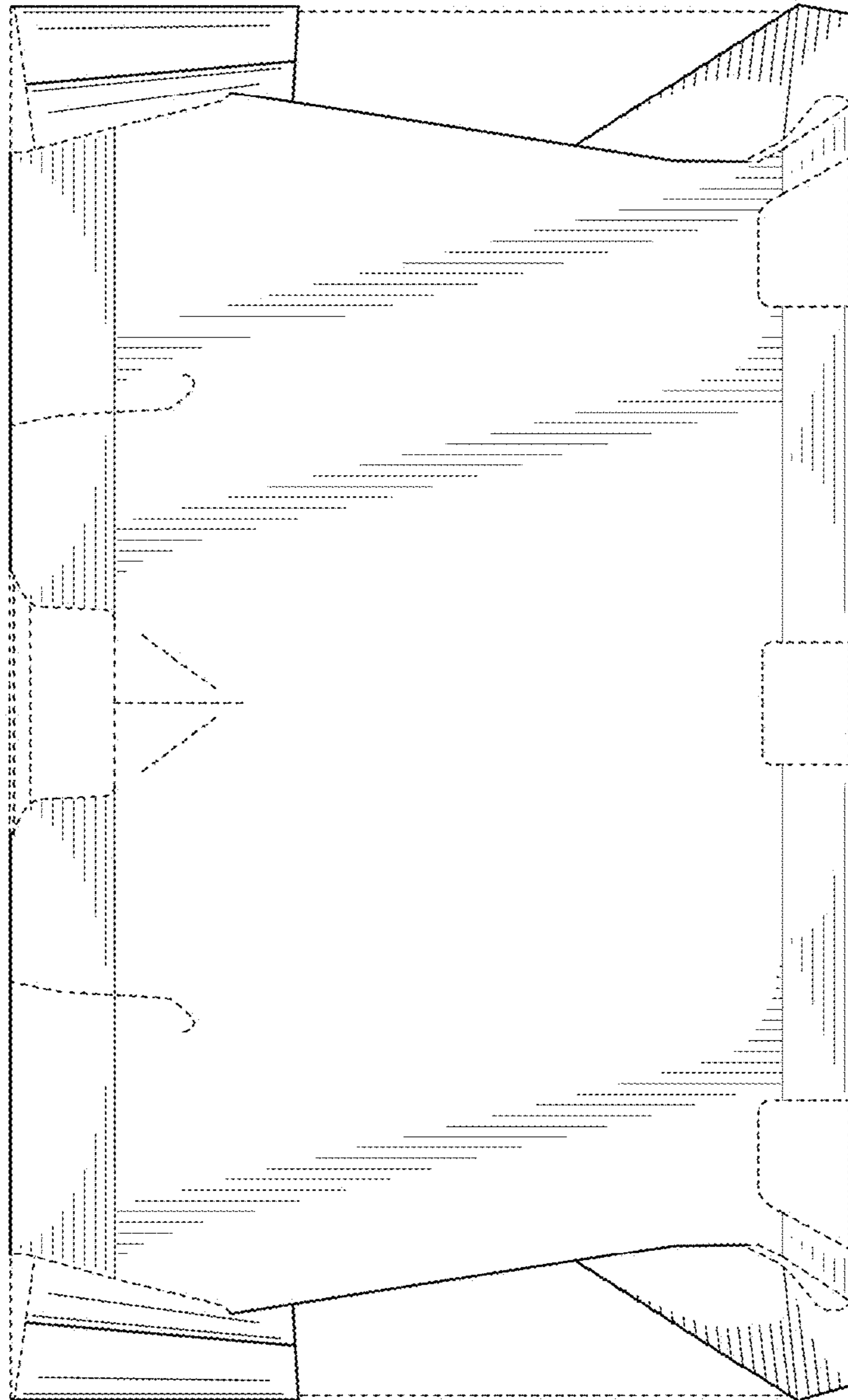

FIG. 3

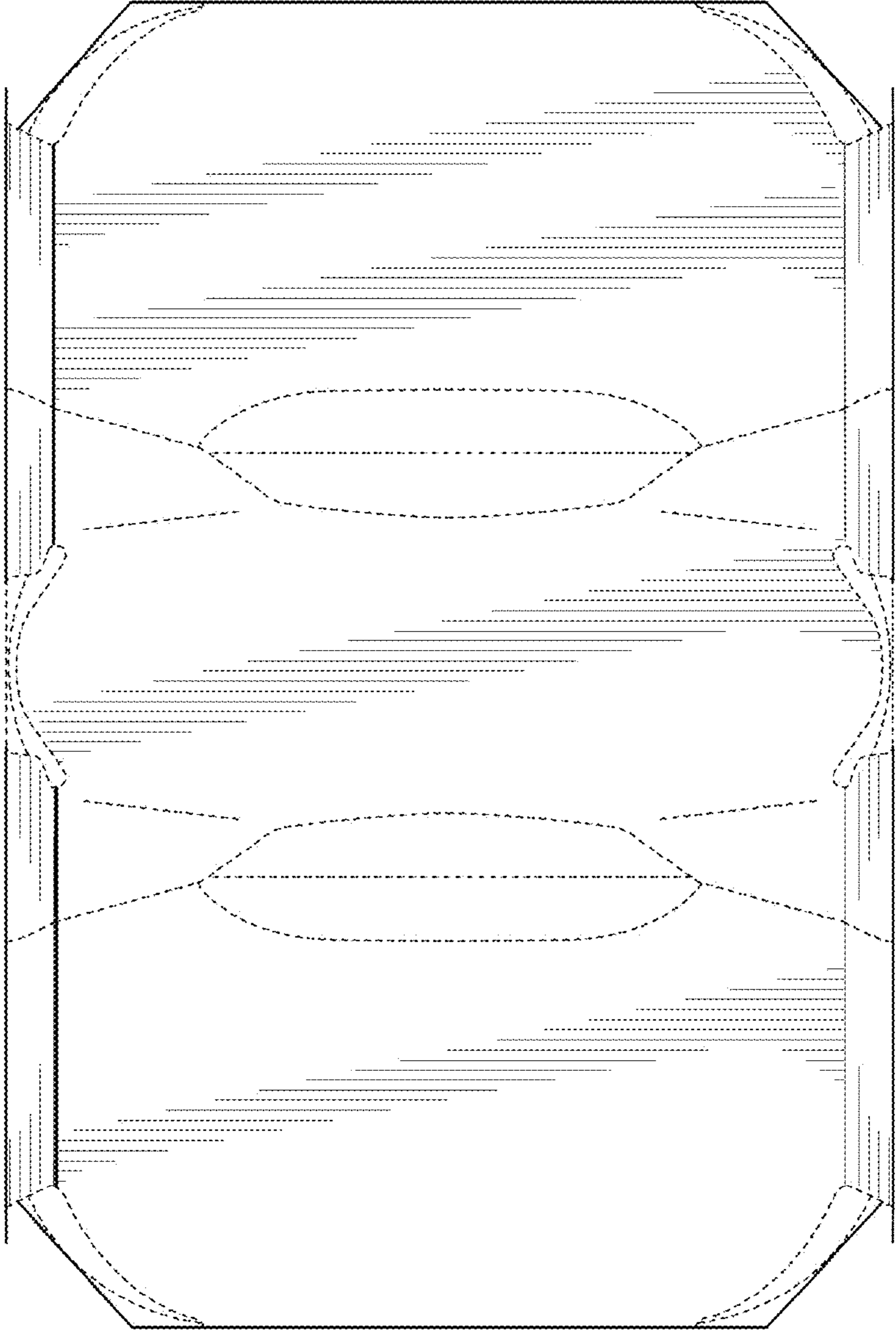

FIG. 4

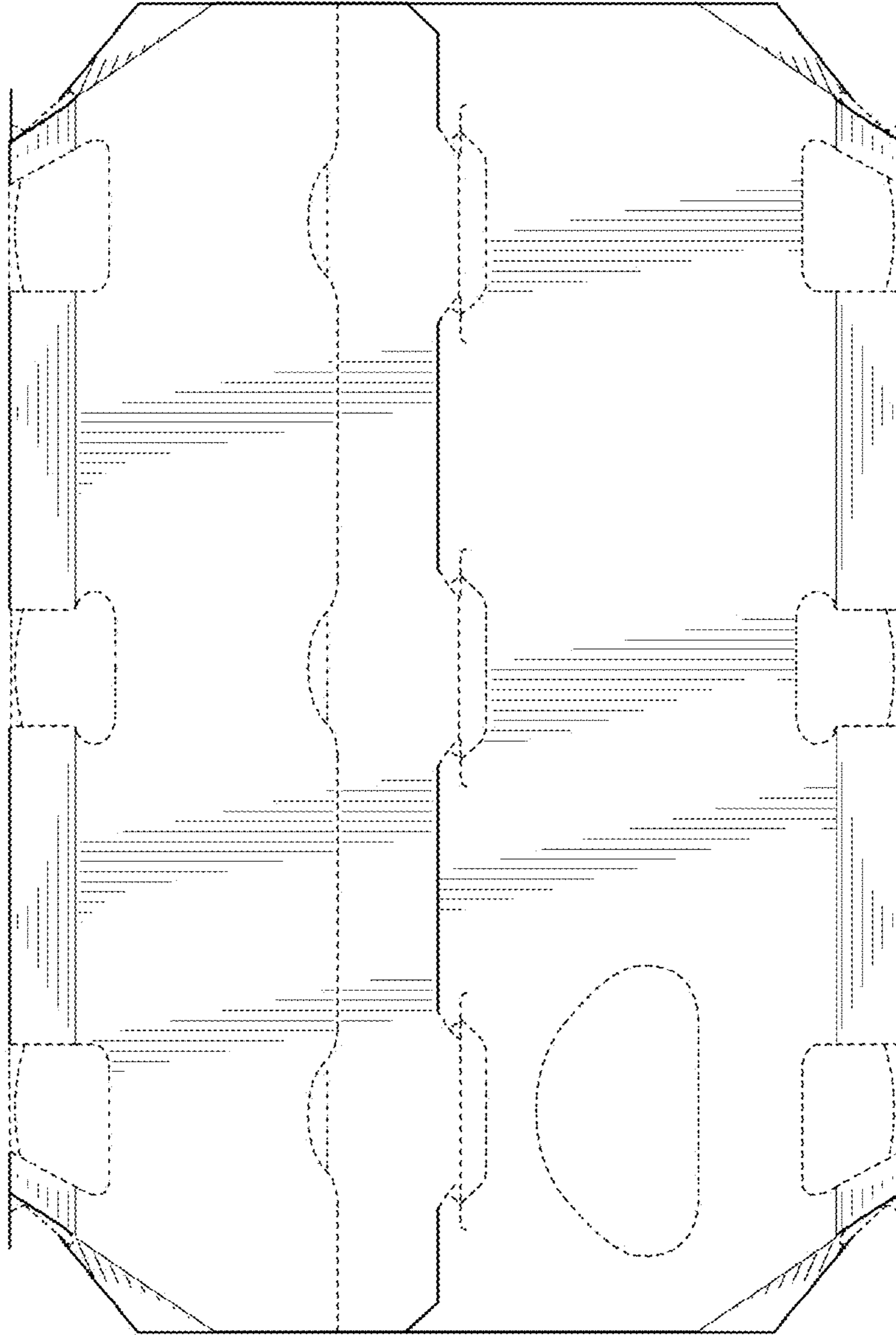

FIG. 5

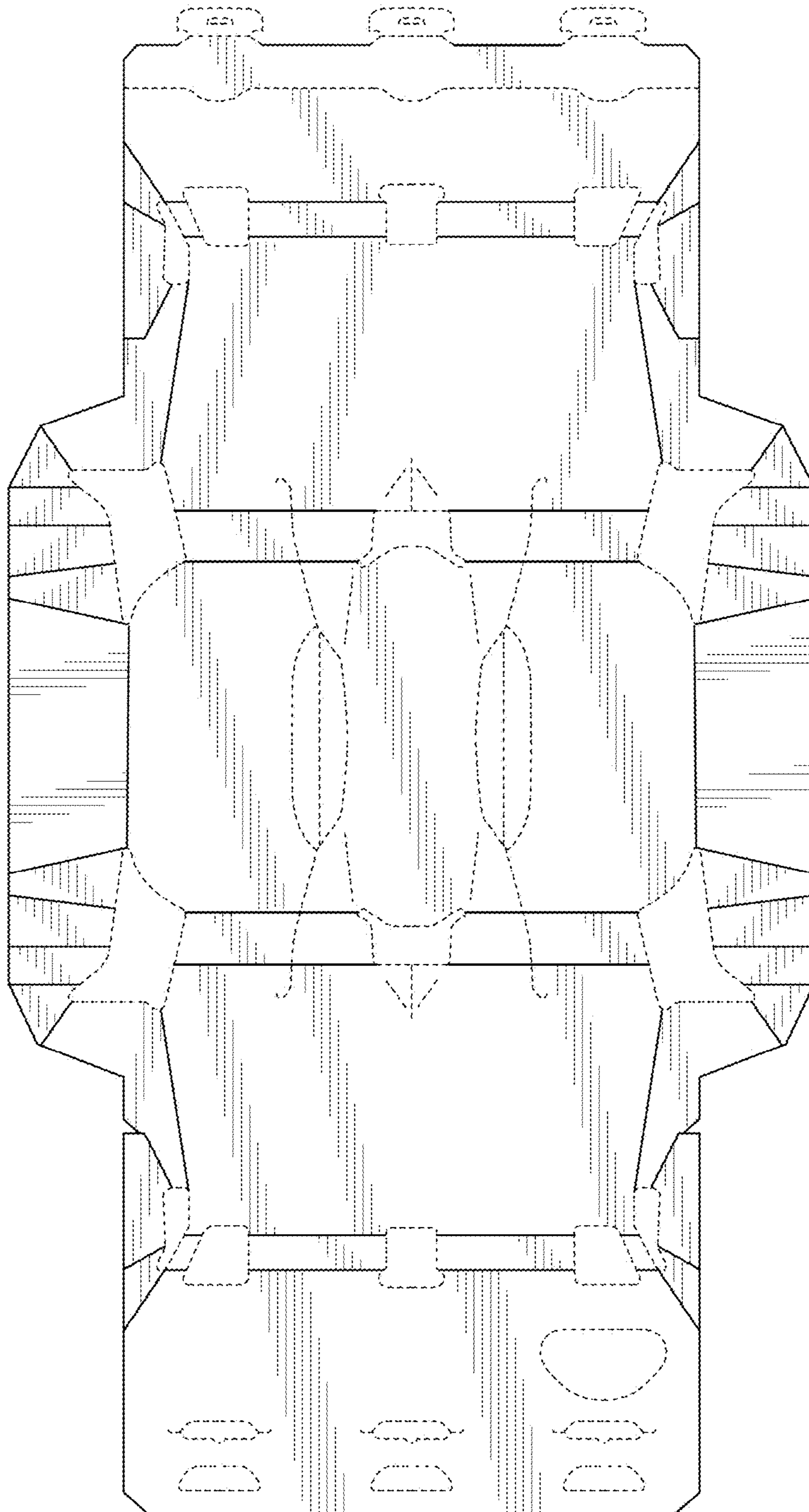

FIG. 6