

US00D867871S

(12) **United States Design Patent** (10) **Patent No.:** **US D867,871 S**  
**Rubio et al.** (45) **Date of Patent:** **\*\* Nov. 26, 2019**

(54) **PACKAGING FOR LUGGAGE**

(74) *Attorney, Agent, or Firm* — Proskauer Rose LLP

(71) Applicant: **JRSK, Inc.**, New York, NY (US)

(57) **CLAIM**

(72) Inventors: **Jennifer Rubio**, New York, NY (US);  
**Stephanie Korey**, New York, NY (US);  
**Sam Naparstek**, New York, NY (US);  
**Celia Madeleine Lewis**, Brooklyn, NY (US)

The ornamental design for a packaging for luggage, substantially as shown and described.

(73) Assignee: **JRSK, Inc.**, New York, NY (US)

**DESCRIPTION**

(\*\*) Term: **15 Years**

(21) Appl. No.: **29/640,642**

(22) Filed: **Mar. 15, 2018**

(51) **LOC (12) Cl.** ..... **09-03**

(52) **U.S. Cl.**  
USPC ..... **D9/424**

(58) **Field of Classification Search**  
USPC ..... D9/414, 415, 416, 418, 424, 425, 432,  
D9/737, 759, 760; D3/201, 203.1, 264;  
D7/553.3, 554.1, 554.3, 554.4, 555, 586,  
D7/587

CPC ..... B65D 81/3453; B65D 1/34; B65D  
2543/00296; B65D 25/04; B65D  
2543/00194; B65D 2571/0066; B65D  
75/36; B65D 2519/00034; B65D  
2519/00323; B65D 85/00; B65D  
2519/00069; B65D 2519/00288; B65D  
2519/00318; B65D 75/366; B65D 1/36;

(Continued)

(56) **References Cited**

**U.S. PATENT DOCUMENTS**

3,463,378 A \* 8/1969 Daalen ..... B65D 1/48  
206/512  
D227,191 S \* 6/1973 Cape ..... D3/312

(Continued)

FIG. 1 is a perspective view of a packaging for luggage.  
 FIG. 2 is a front view thereof.  
 FIG. 3 is a rear view thereof.  
 FIG. 4 is a left side view thereof.  
 FIG. 5 is a right side view thereof.  
 FIG. 6 is a top view thereof.  
 FIG. 7 is a bottom view thereof.  
 FIG. 8 is a perspective view of a packaging for luggage according to a second embodiment.  
 FIG. 9 is a front view thereof.  
 FIG. 10 is a rear view thereof.  
 FIG. 11 is a left side view thereof.  
 FIG. 12 is a right side view thereof.  
 FIG. 13 is a top view thereof.  
 FIG. 14 is a bottom view thereof.  
 FIG. 15 a perspective view of a packaging for luggage according to a third embodiment.  
 FIG. 16 is a front view thereof.  
 FIG. 17 is a rear view thereof.  
 FIG. 18 is a left side view thereof.  
 FIG. 19 is a right side view thereof.  
 FIG. 20 is a top view thereof.  
 FIG. 21 is a bottom view thereof.  
 FIG. 22 is a perspective view of a packaging for luggage according to a fourth embodiment.  
 FIG. 23 is a front view thereof.  
 FIG. 24 is a rear view thereof.  
 FIG. 25 is a left side view thereof.  
 FIG. 26 is a right side view thereof.  
 FIG. 27 is a top view thereof; and,  
 FIG. 28 is a bottom view thereof.

The broken lines shown represent subject matter that forms no part of the claimed design.

*Primary Examiner* — Lauren R Calve

**1 Claim, 20 Drawing Sheets**

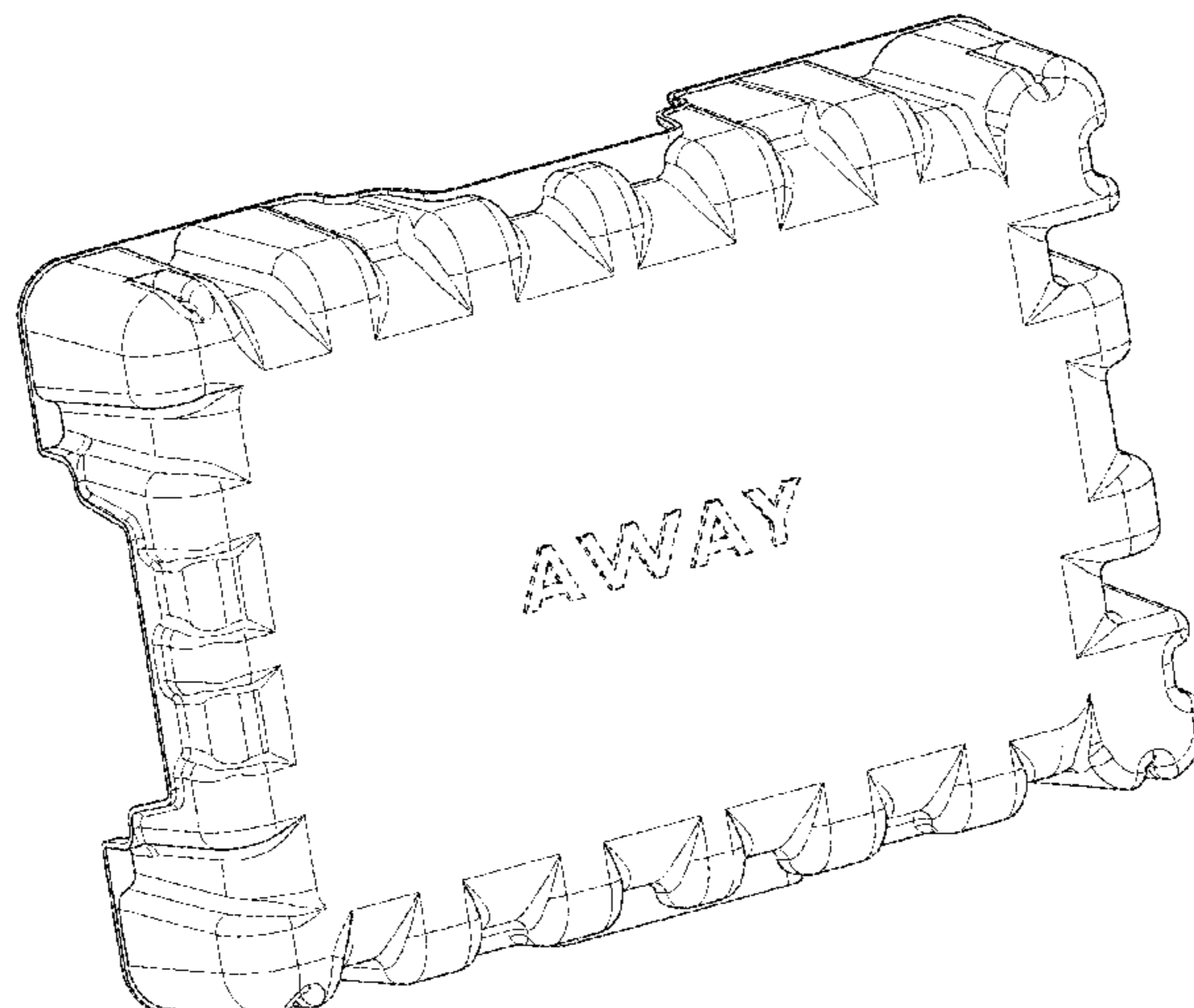

(58) **Field of Classification Search**

CPC ..... B65D 1/0223; B65D 2519/00268; B65D  
2519/00139; B65D 2519/00174  
See application file for complete search history.

(56) **References Cited**

U.S. PATENT DOCUMENTS

D228,263 S \* 8/1973 Jones ..... D3/307  
D242,660 S \* 12/1976 Astle ..... D3/314  
D247,025 S \* 1/1978 Cherry ..... D3/312  
4,316,540 A \* 2/1982 Lapham ..... B65D 21/04  
206/507  
D272,288 S \* 1/1984 Pfaff ..... D3/304  
D320,298 S \* 9/1991 Apps ..... D3/312  
5,992,628 A \* 11/1999 Vermilion ..... B65D 1/22  
206/447  
6,021,903 A \* 2/2000 Hanson ..... B65D 51/28  
206/541  
D436,728 S \* 1/2001 Harding ..... D3/201

6,298,989 B1 \* 10/2001 Chu ..... B65D 81/025  
206/320  
D461,123 S \* 8/2002 Hayes ..... D9/425  
D508,819 S \* 8/2005 Mangla ..... D14/203.3  
D648,535 S \* 11/2011 Reinhart ..... D3/302  
D663,525 S \* 7/2012 Rhoades ..... D3/314  
D690,514 S \* 10/2013 Shamp ..... D3/304  
D734,610 S \* 7/2015 Christie ..... D3/304  
D770,271 S \* 11/2016 McBride ..... D9/424  
D822,223 S \* 7/2018 Jones ..... D24/216  
2003/0108643 A1 \* 6/2003 Hornsby ..... A23B 4/16  
426/129  
2003/0170352 A1 \* 9/2003 Owen ..... B65D 77/003  
426/129  
2008/0135556 A1 \* 6/2008 Bontrager ..... B65D 1/34  
220/260  
2015/0001127 A1 \* 1/2015 Nelson ..... B29C 51/266  
206/557  
2015/0096915 A1 \* 4/2015 Roberge ..... B65D 1/34  
206/476  
2018/0029767 A1 \* 2/2018 Chung ..... D21H 17/29

\* cited by examiner

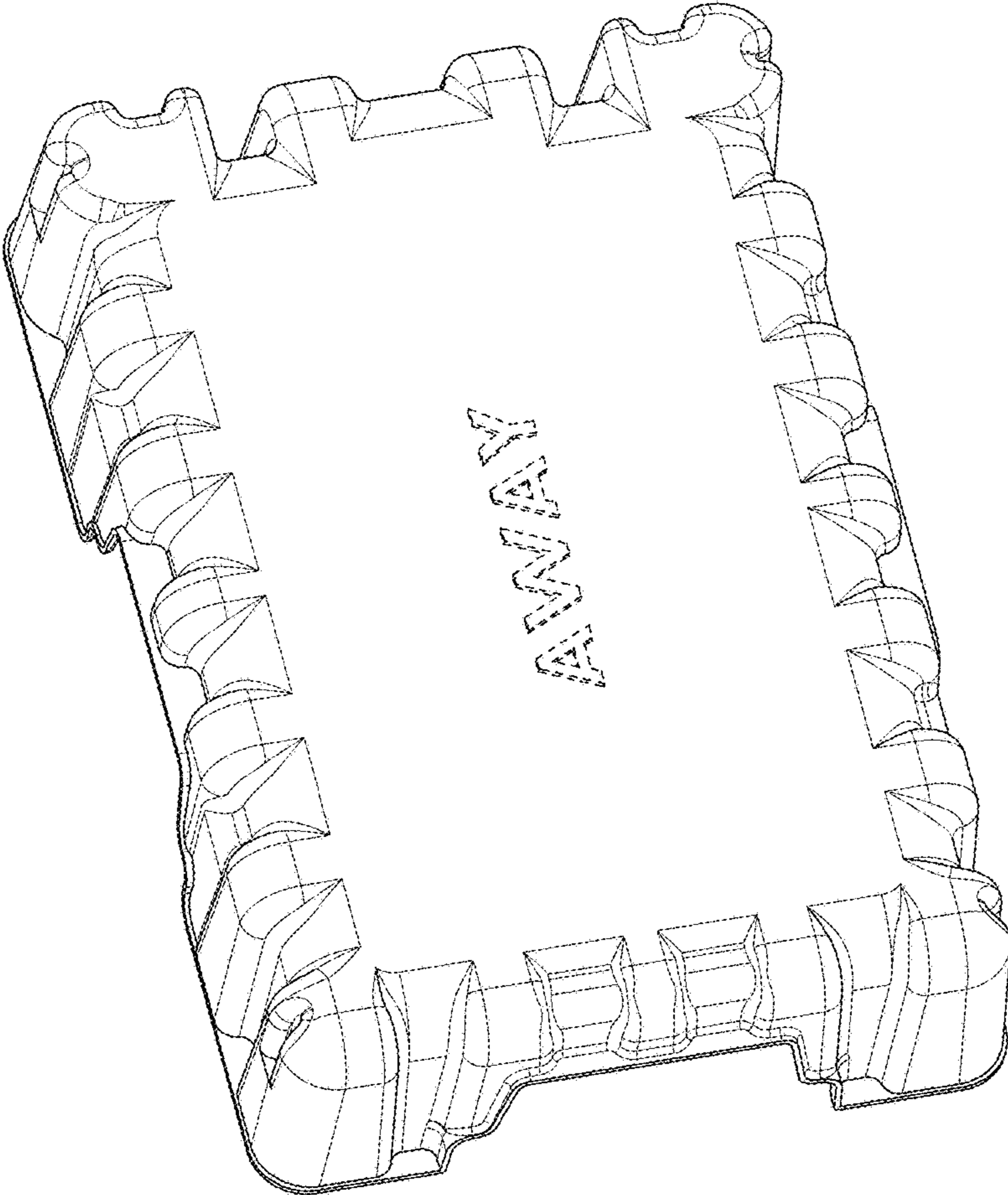

FIG. 1

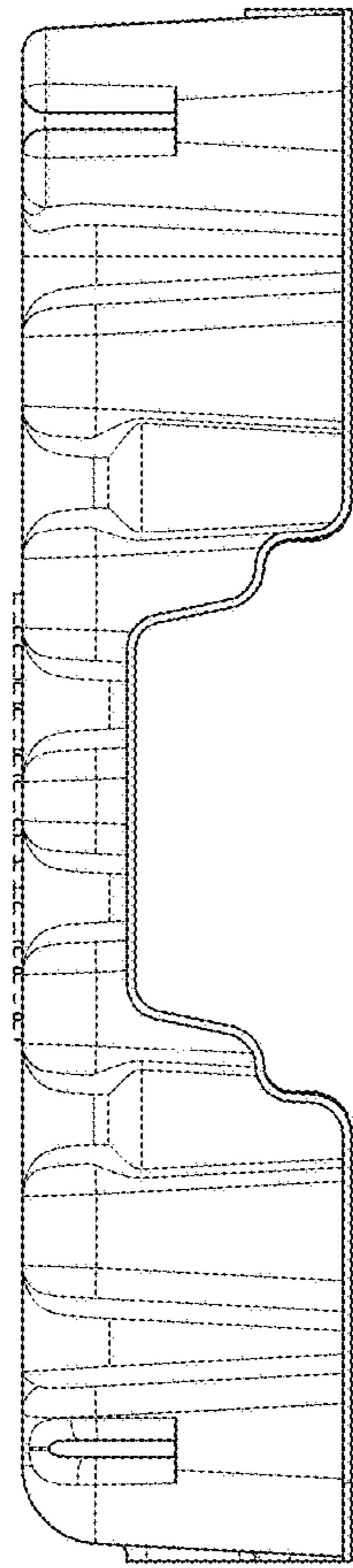

FIG. 2

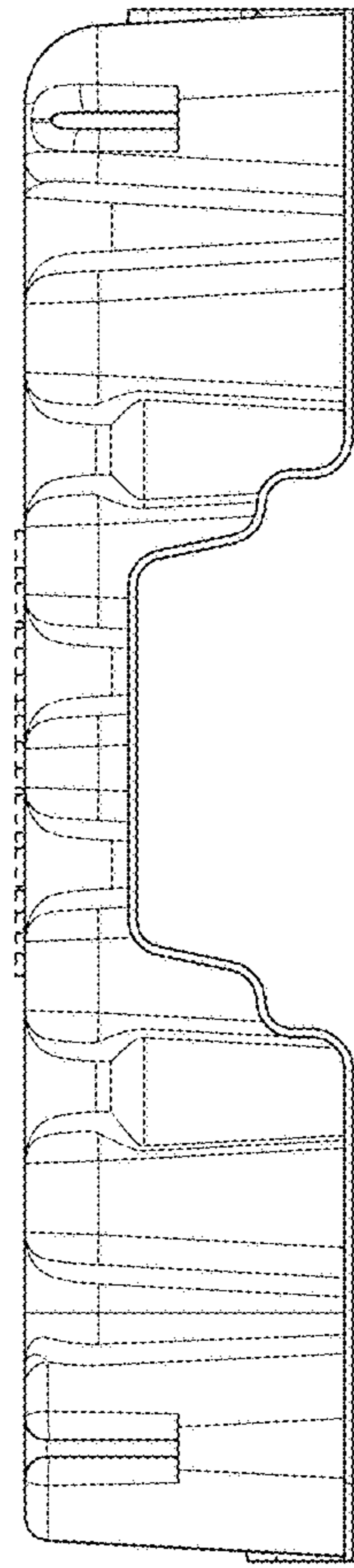

FIG. 3

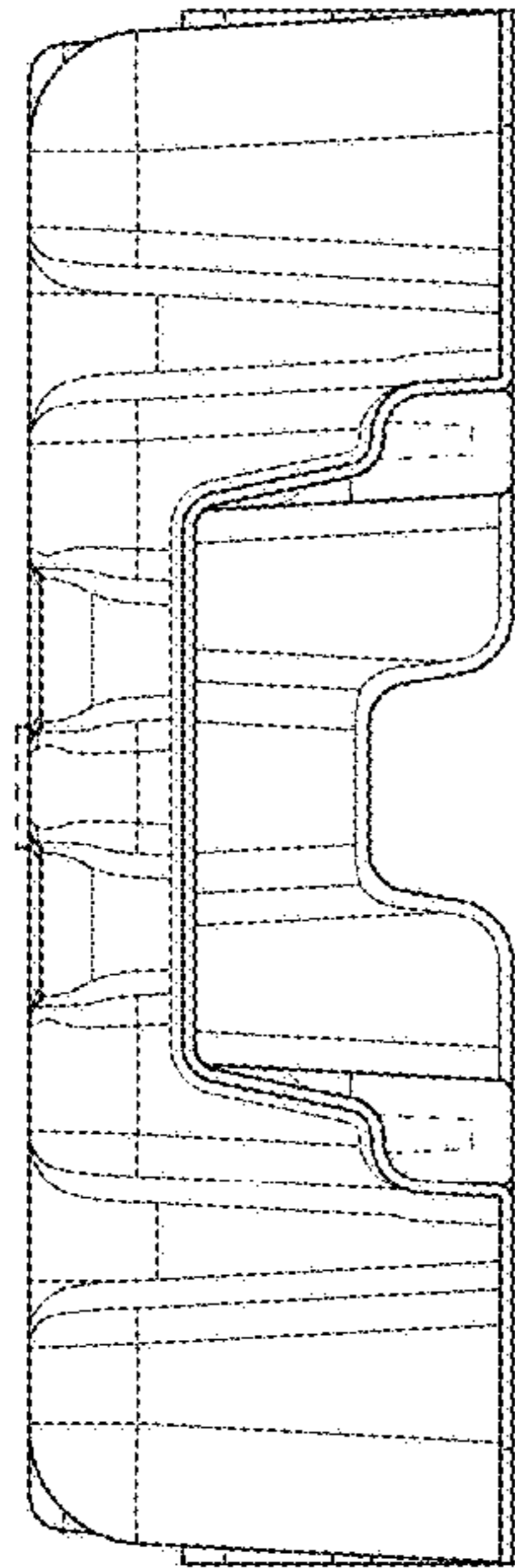

FIG. 4

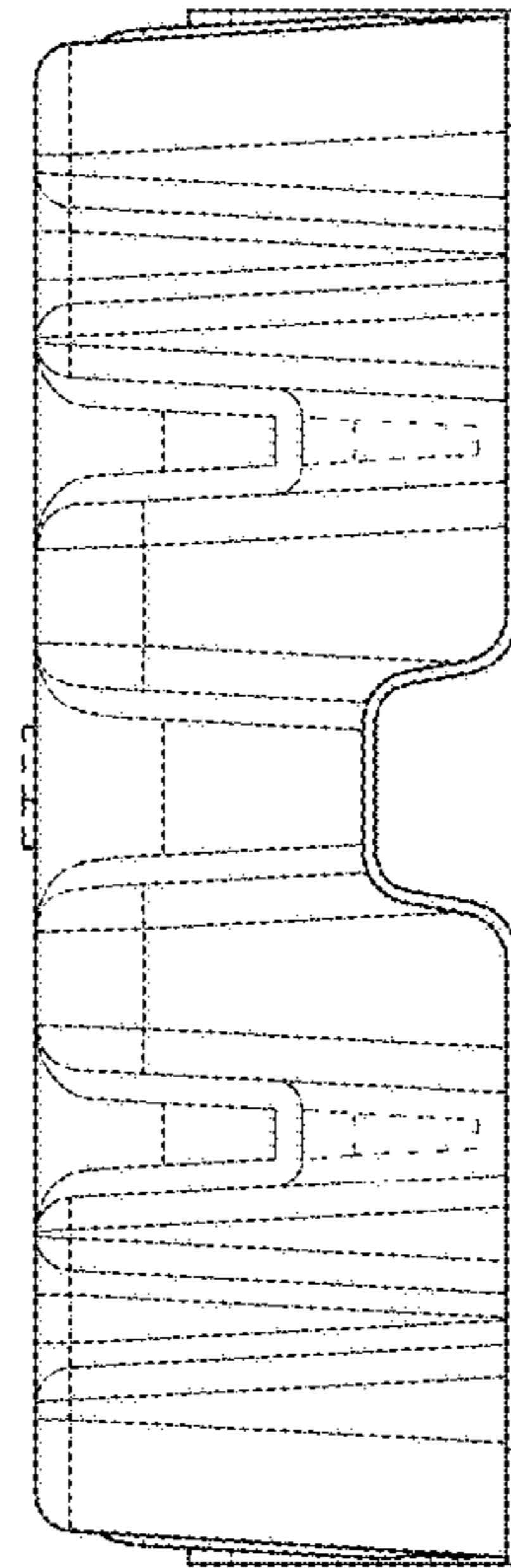

FIG. 5

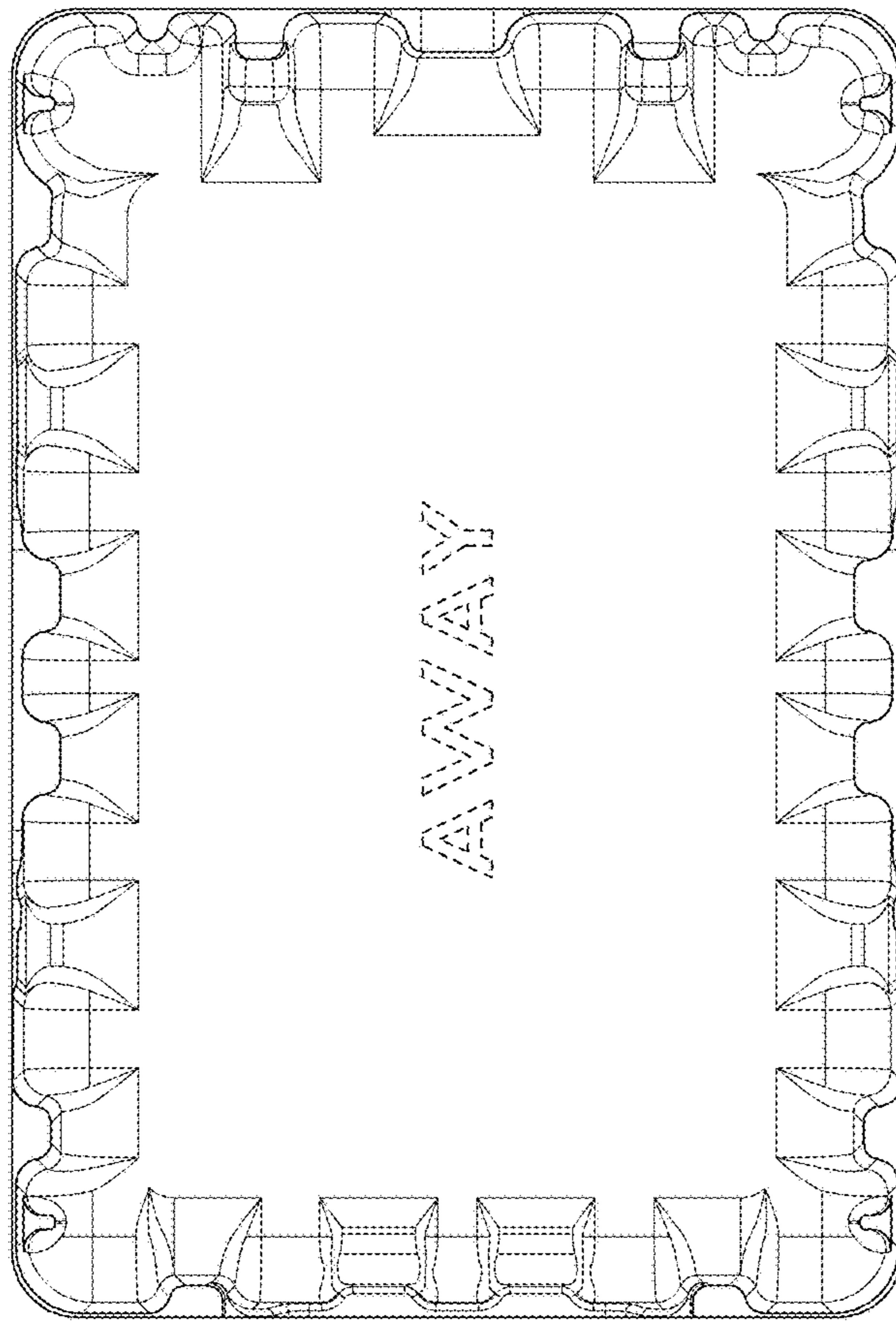

FIG. 6

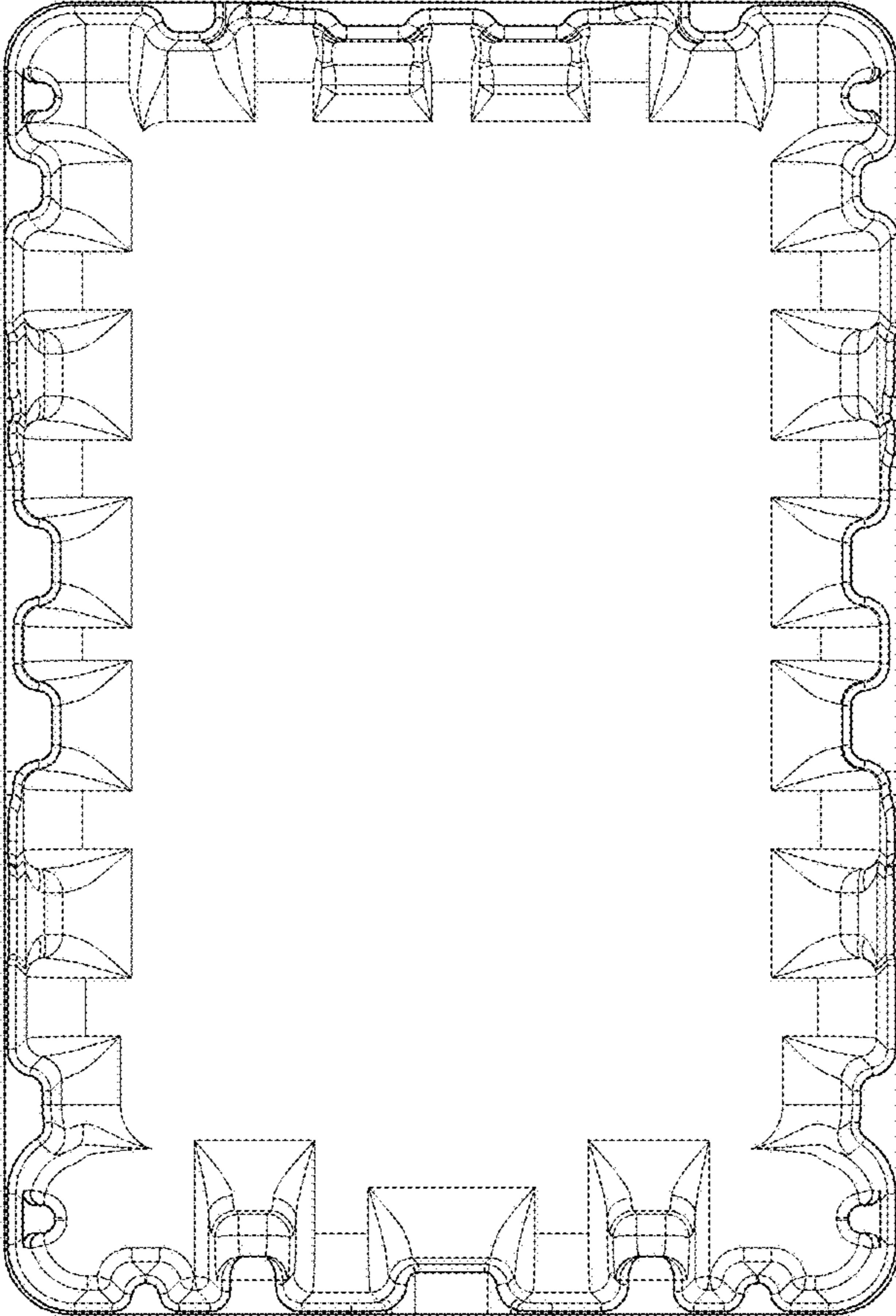

FIG. 7

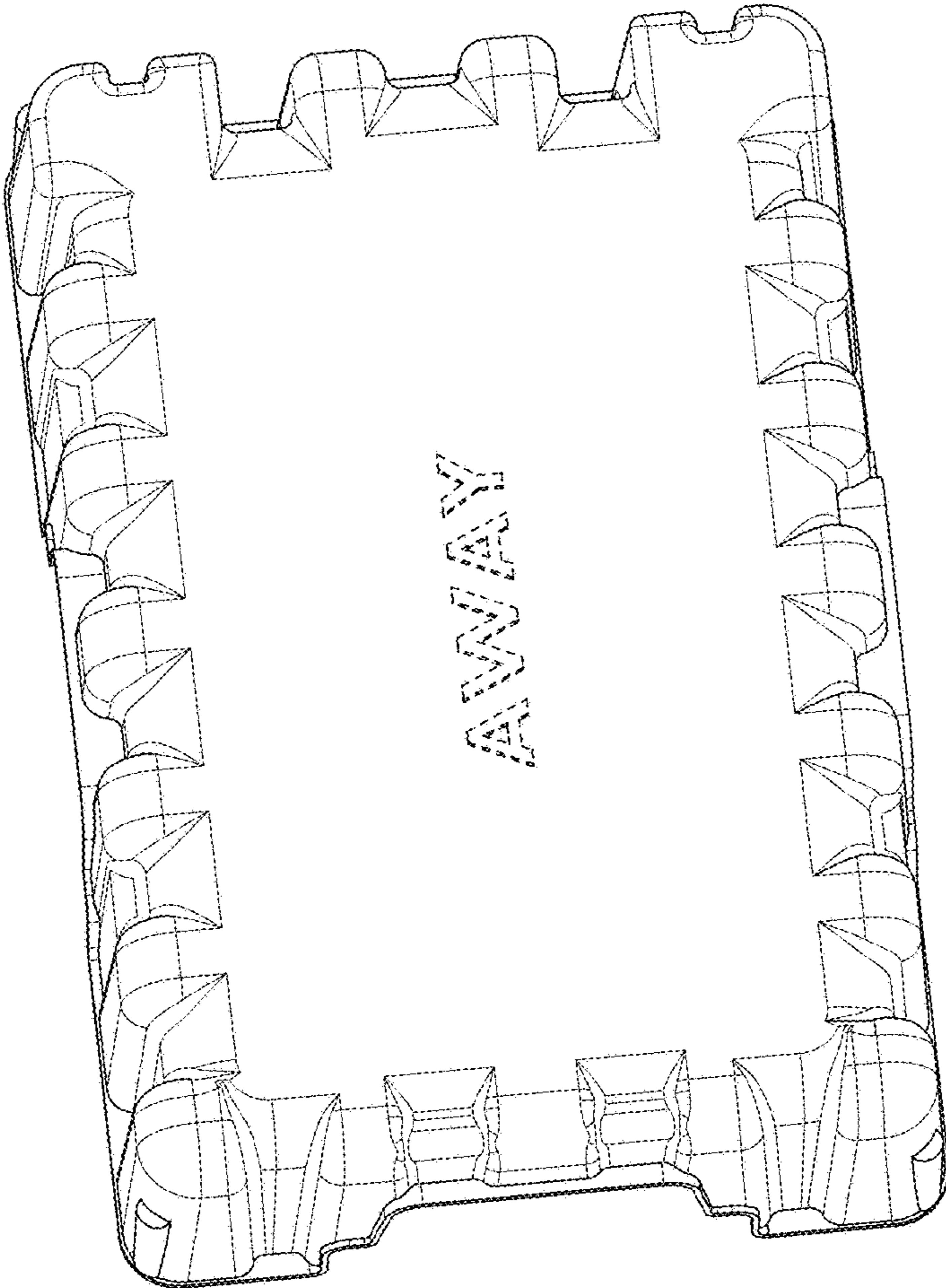

FIG. 8



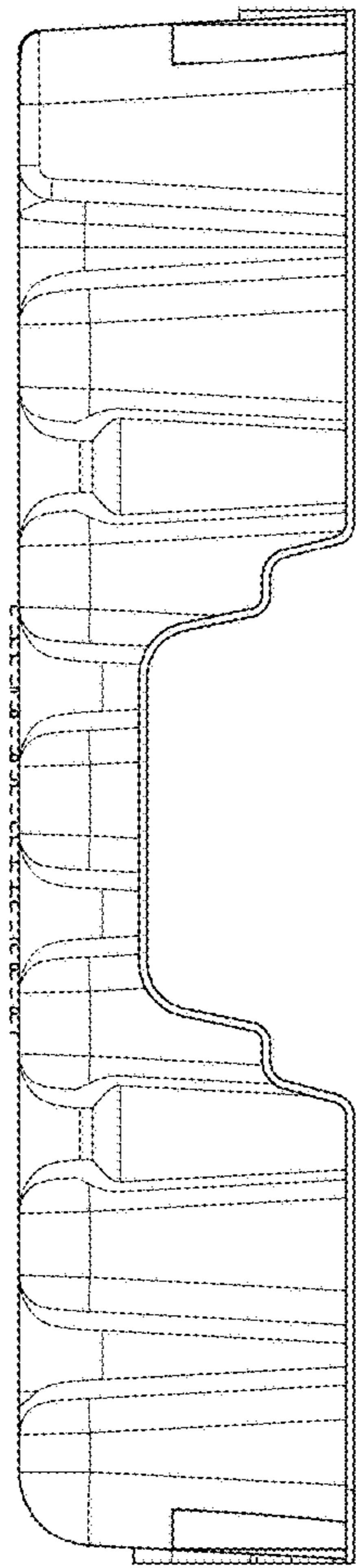

FIG. 9

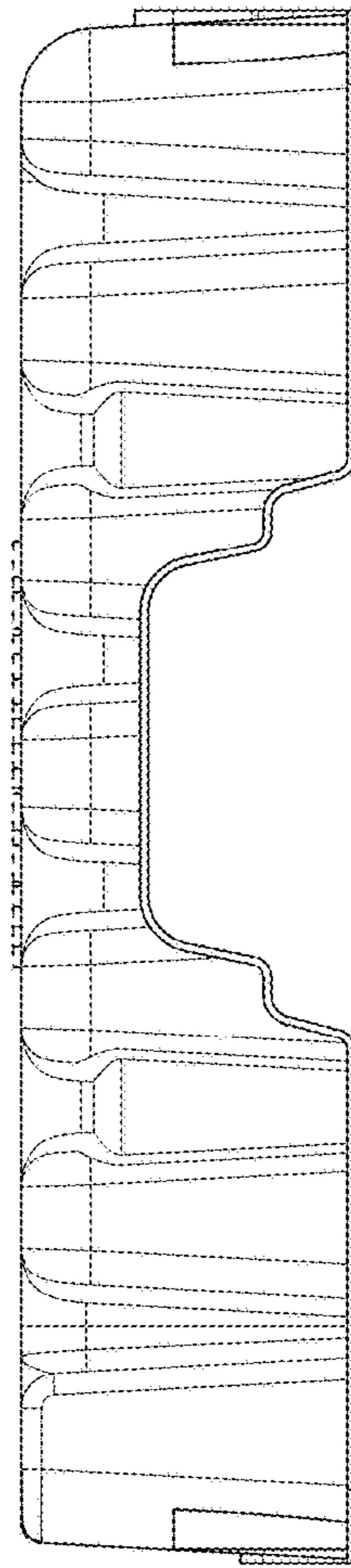

FIG. 10

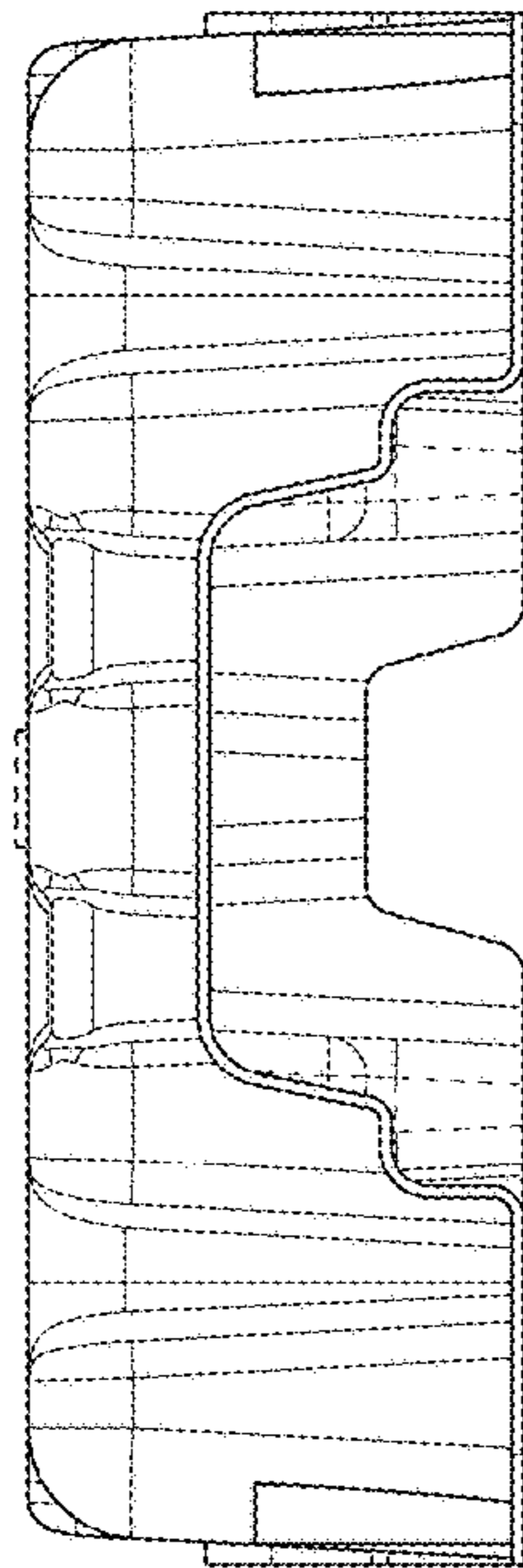

FIG. 11

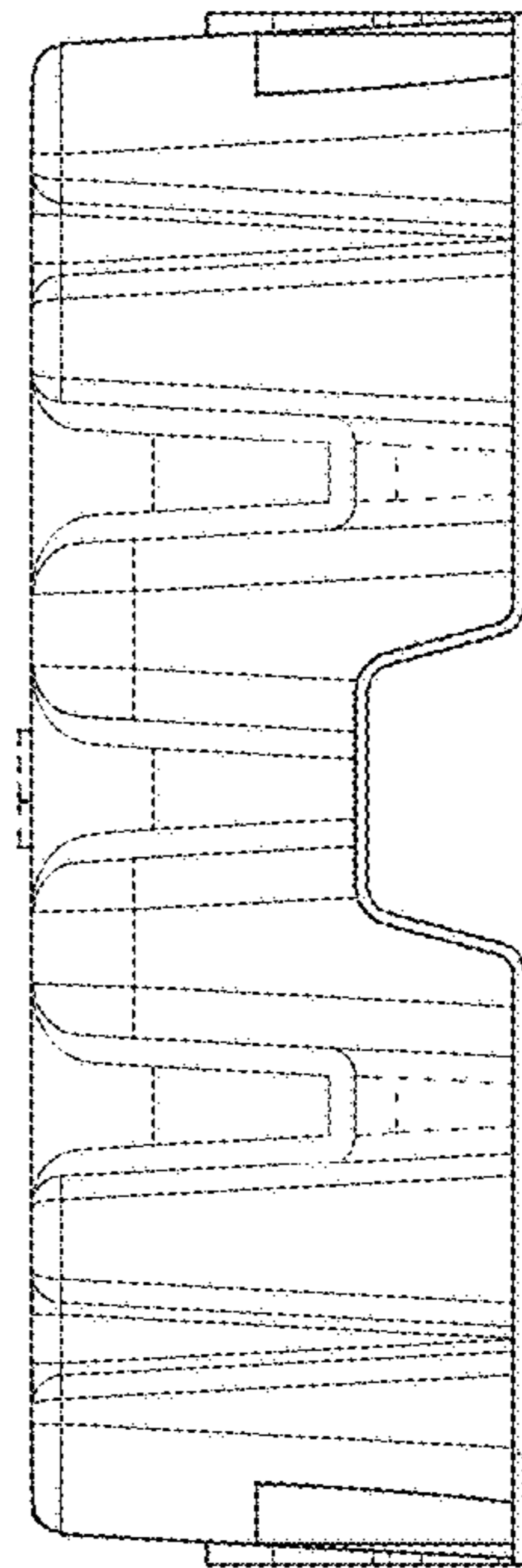

FIG. 12

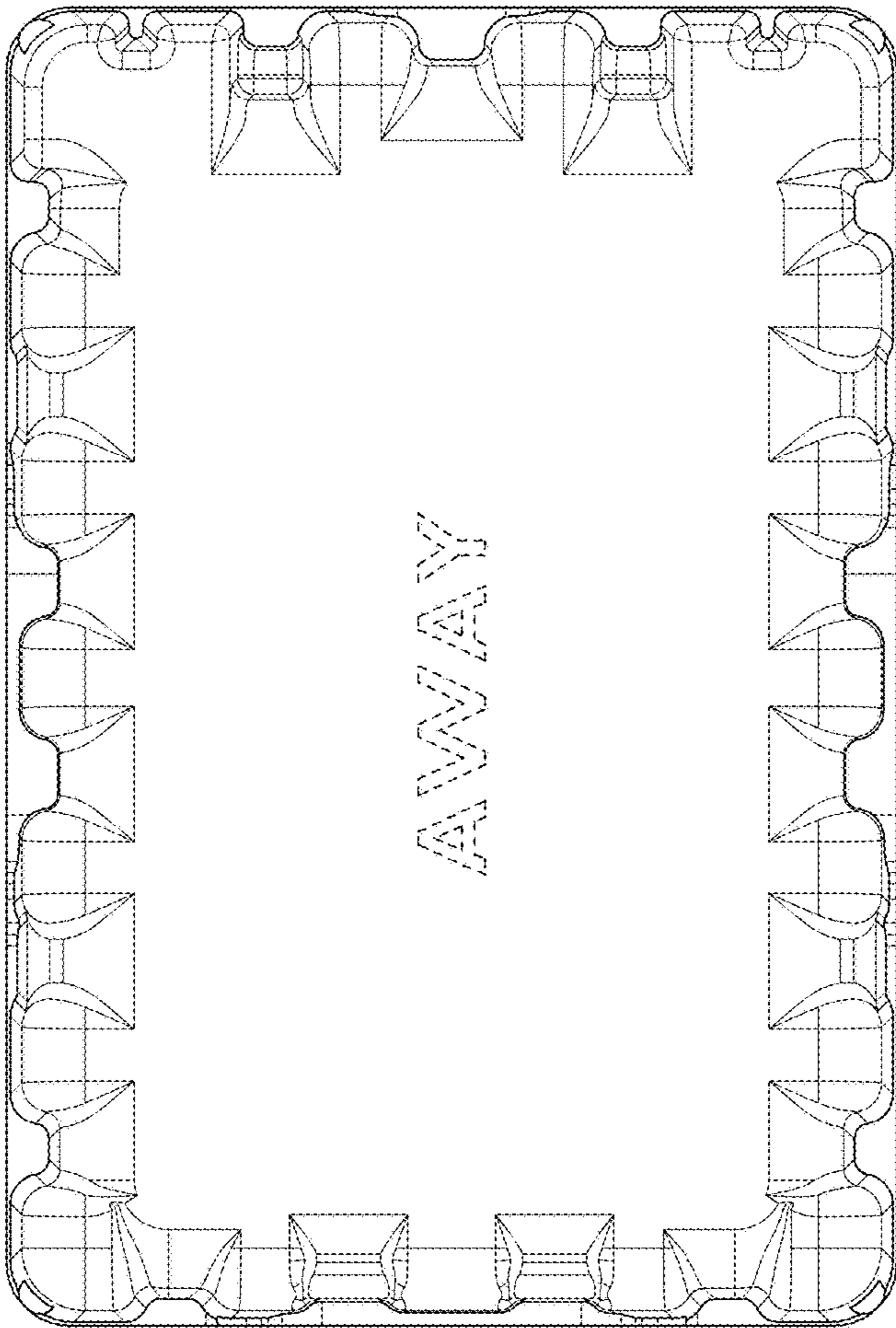

FIG. 13

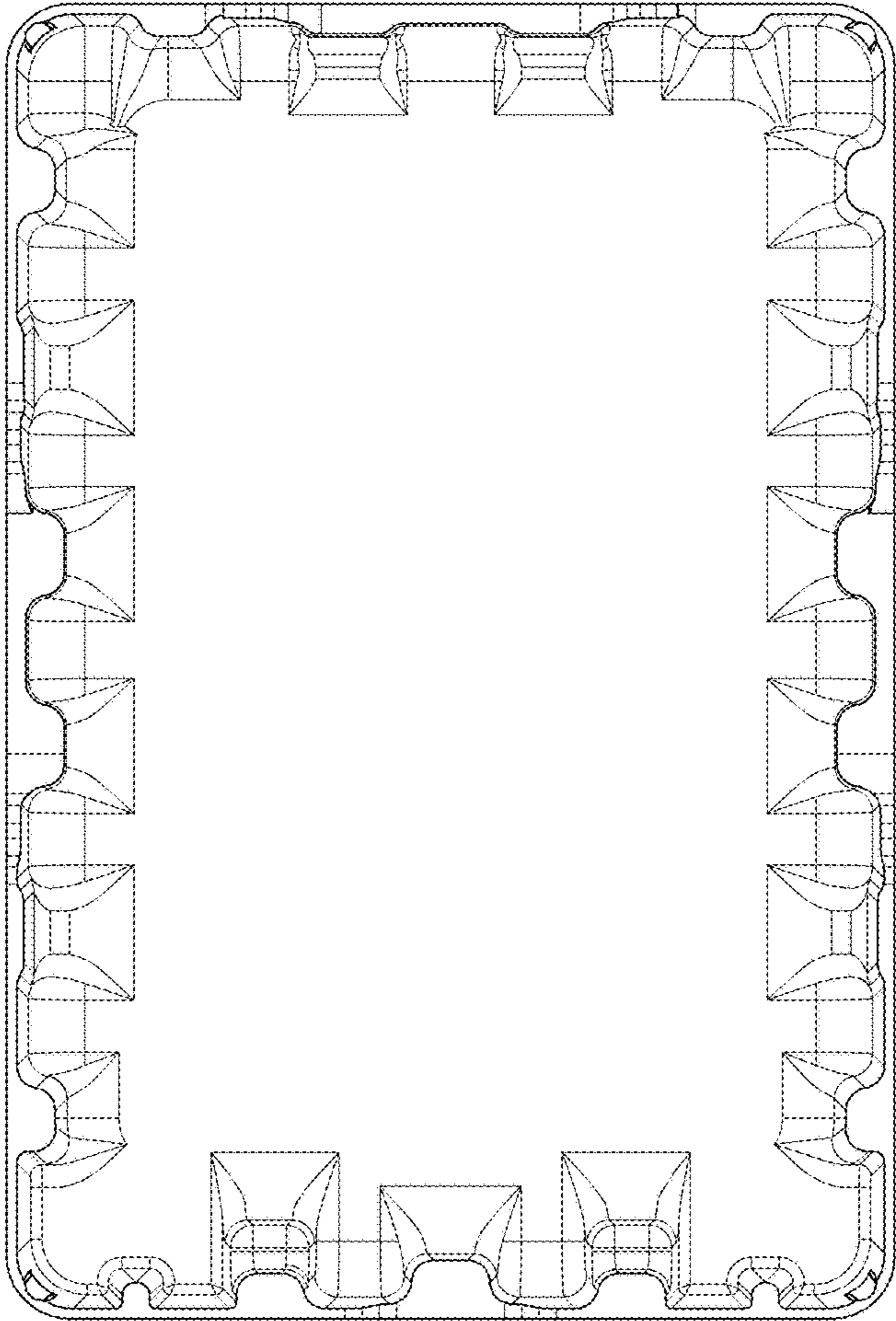

FIG. 14

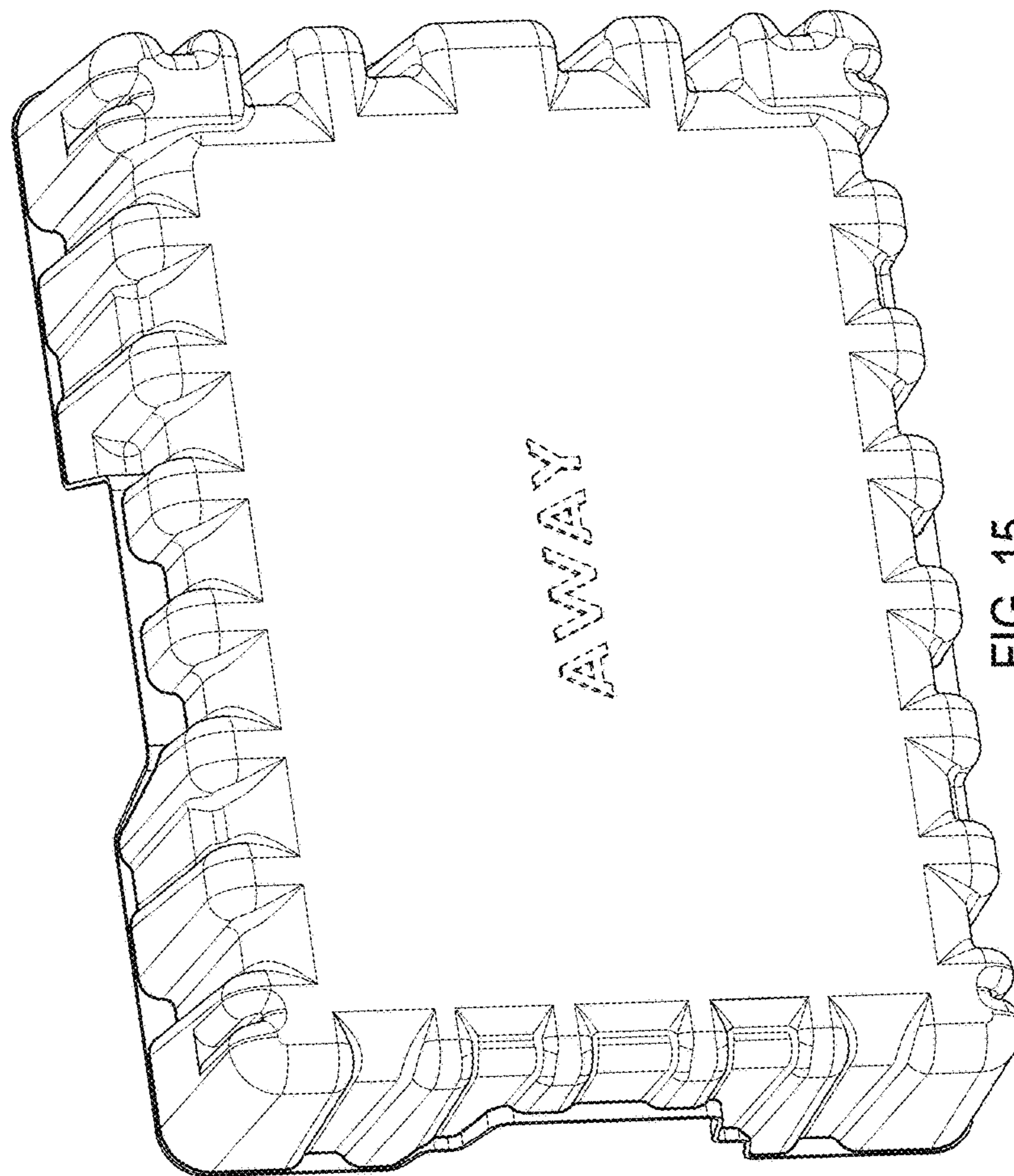

FIG. 15

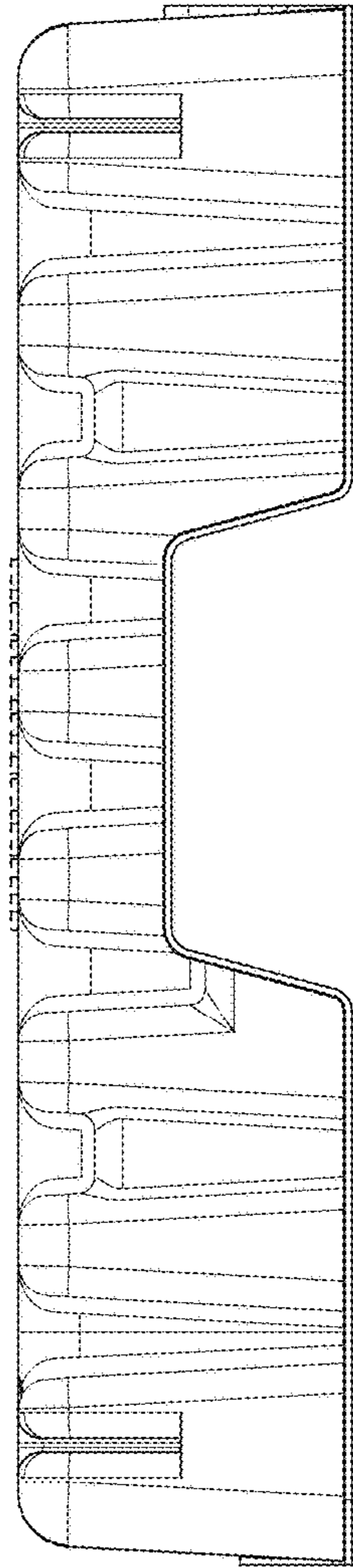

FIG. 16

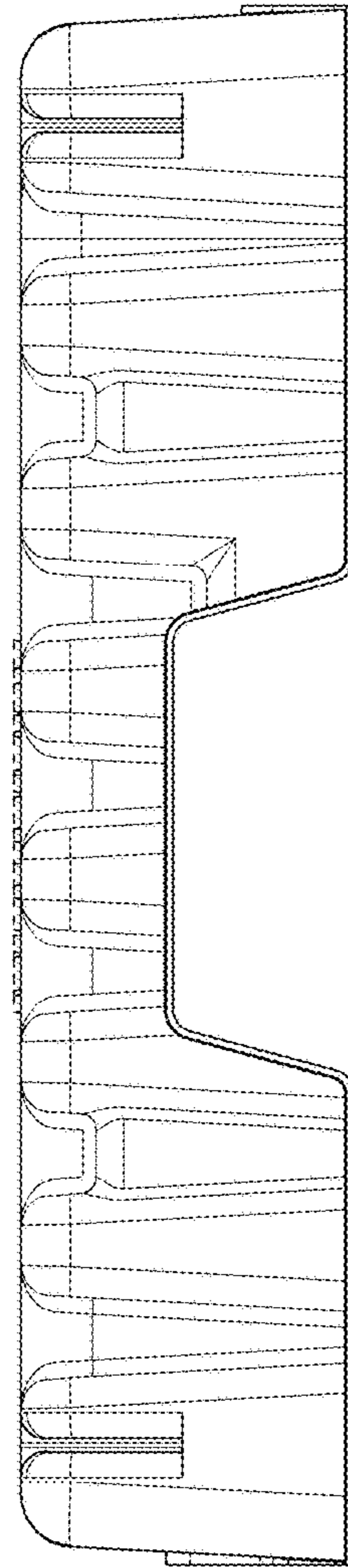

FIG. 17

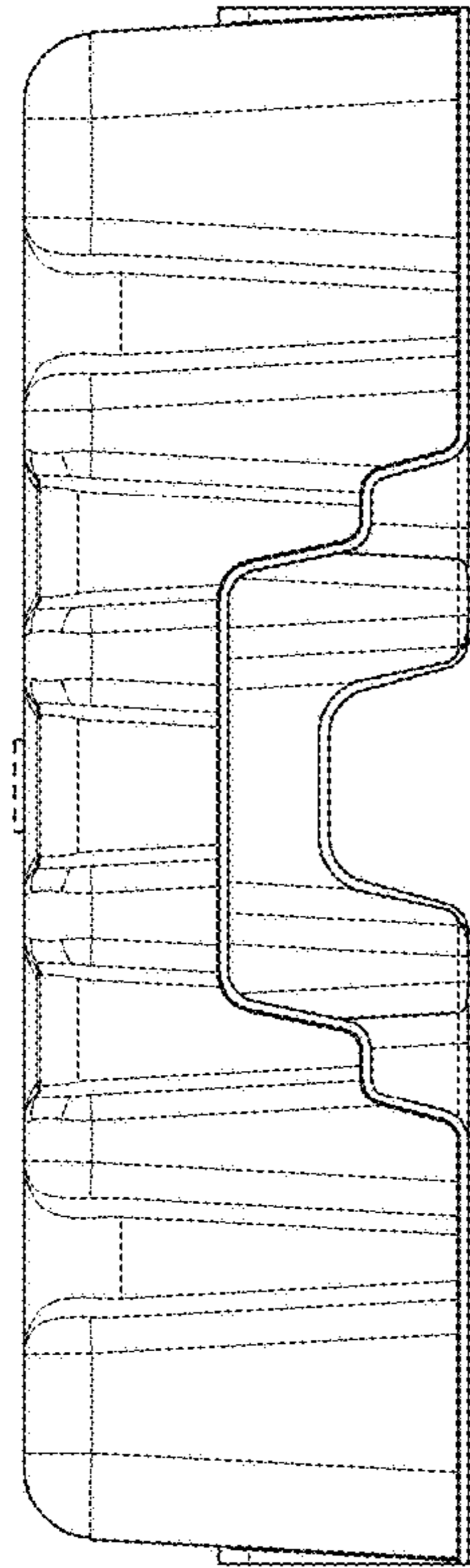

FIG. 18

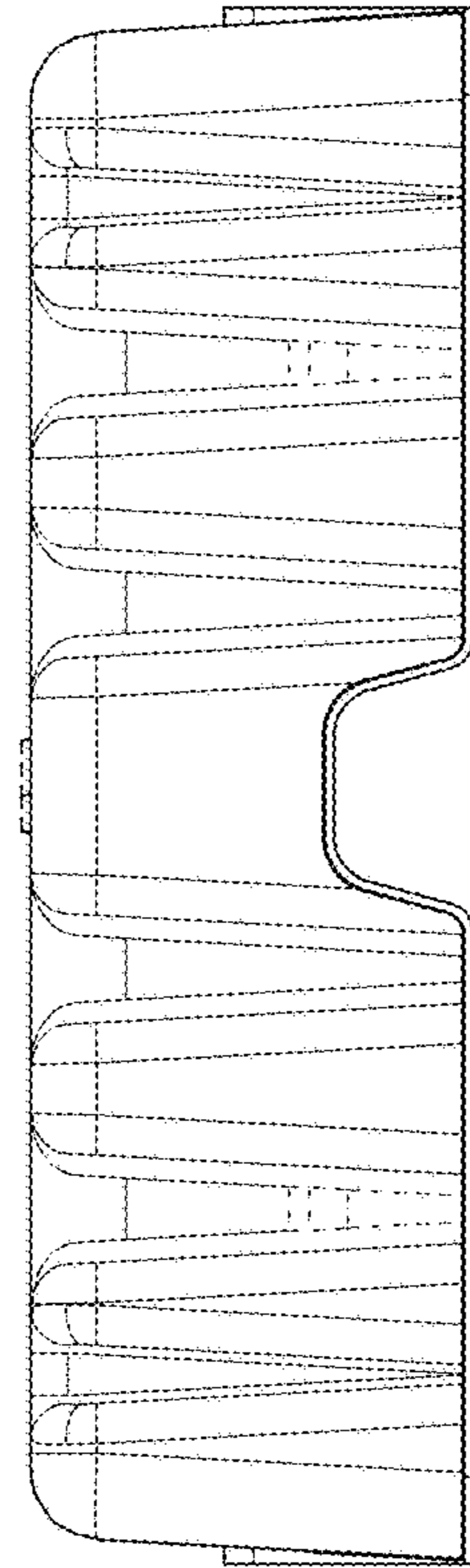

FIG. 19

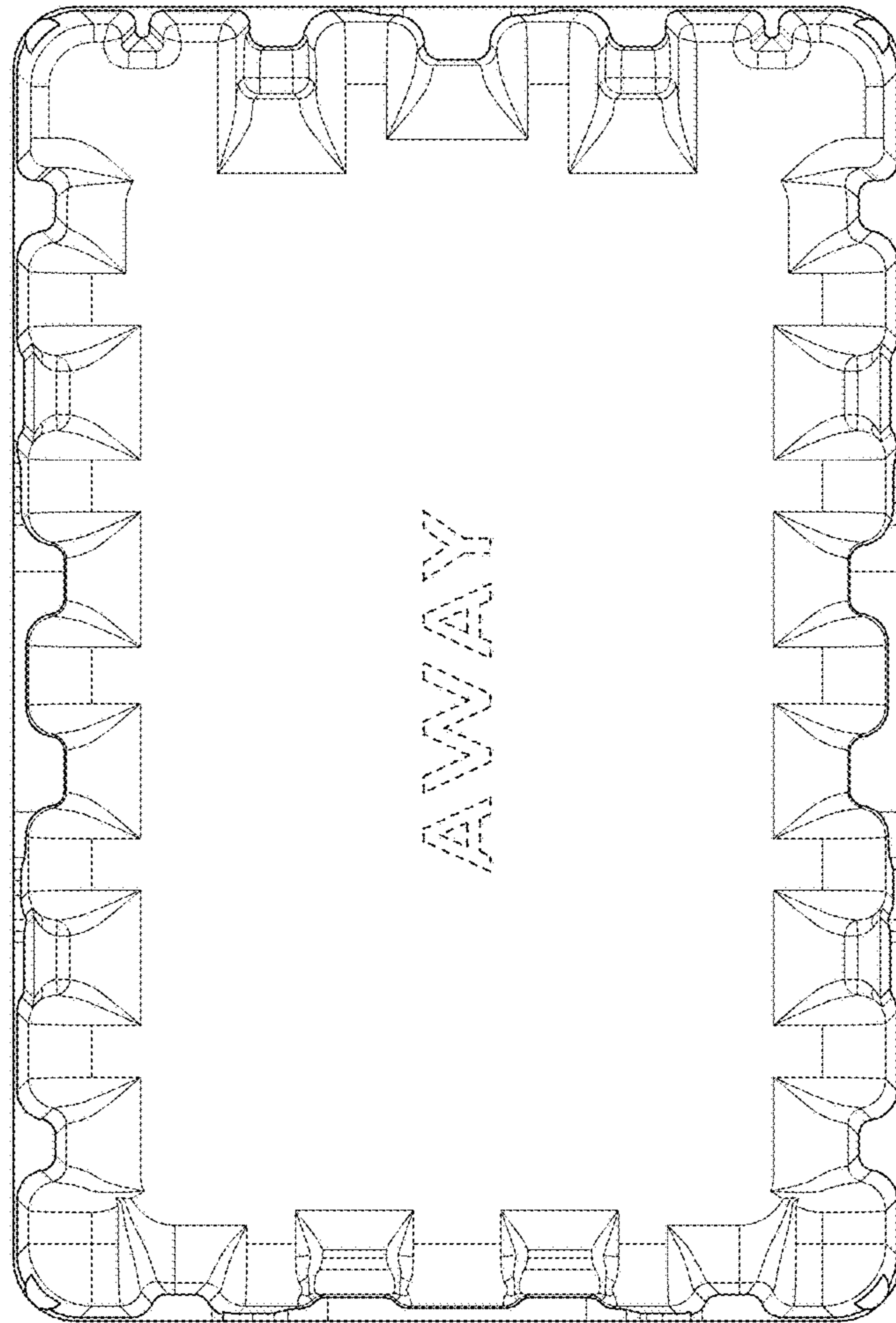

FIG. 20



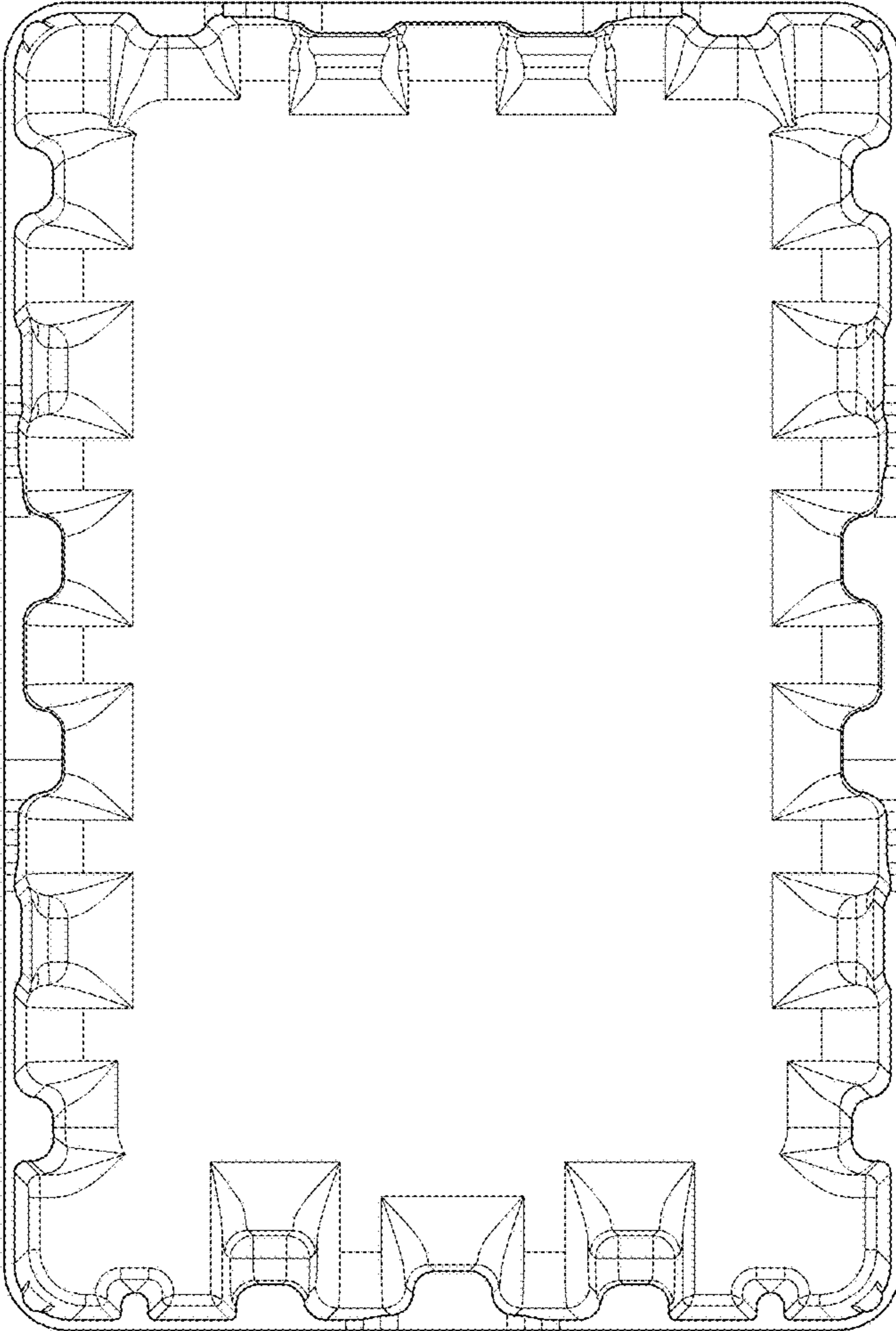

FIG. 21

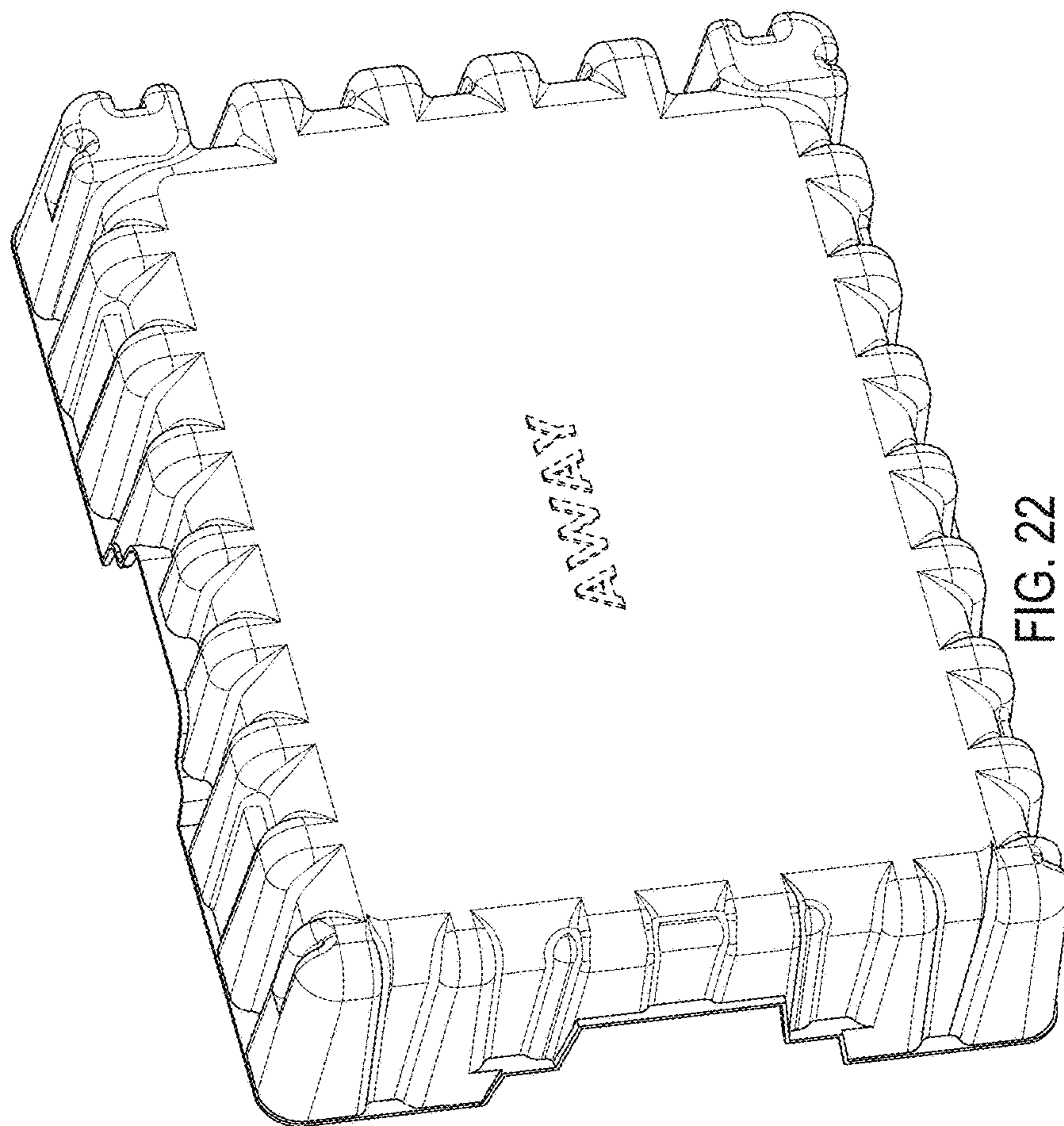

FIG. 22

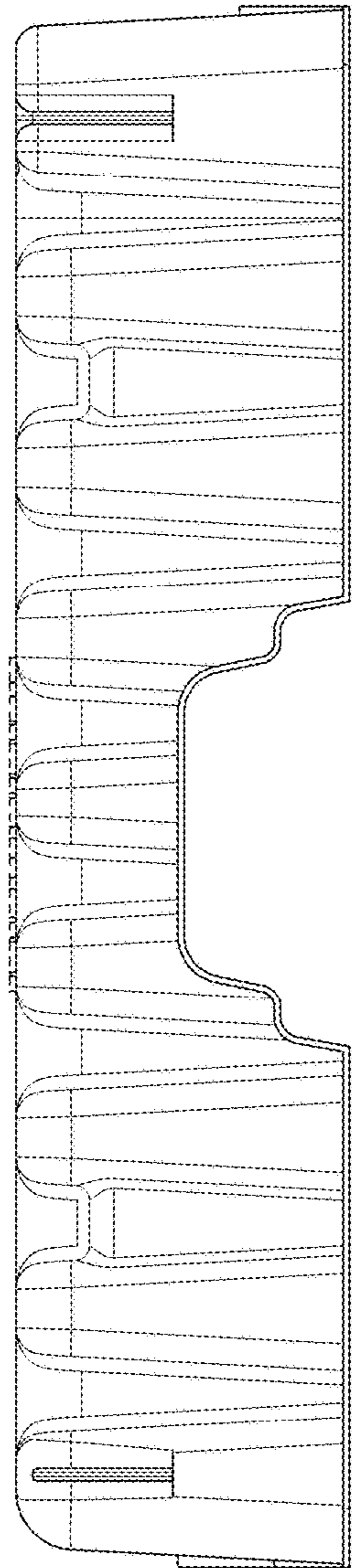

FIG. 23

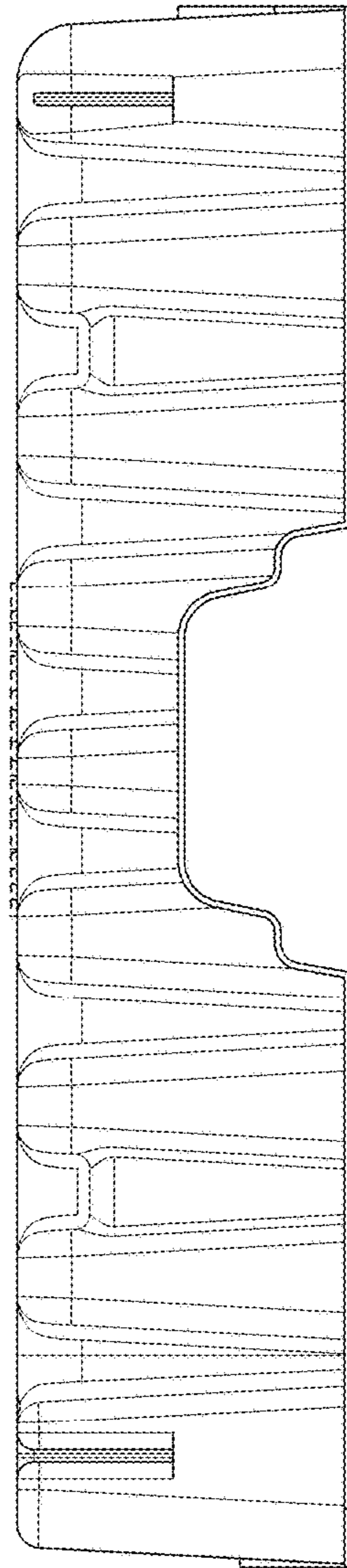

FIG. 24

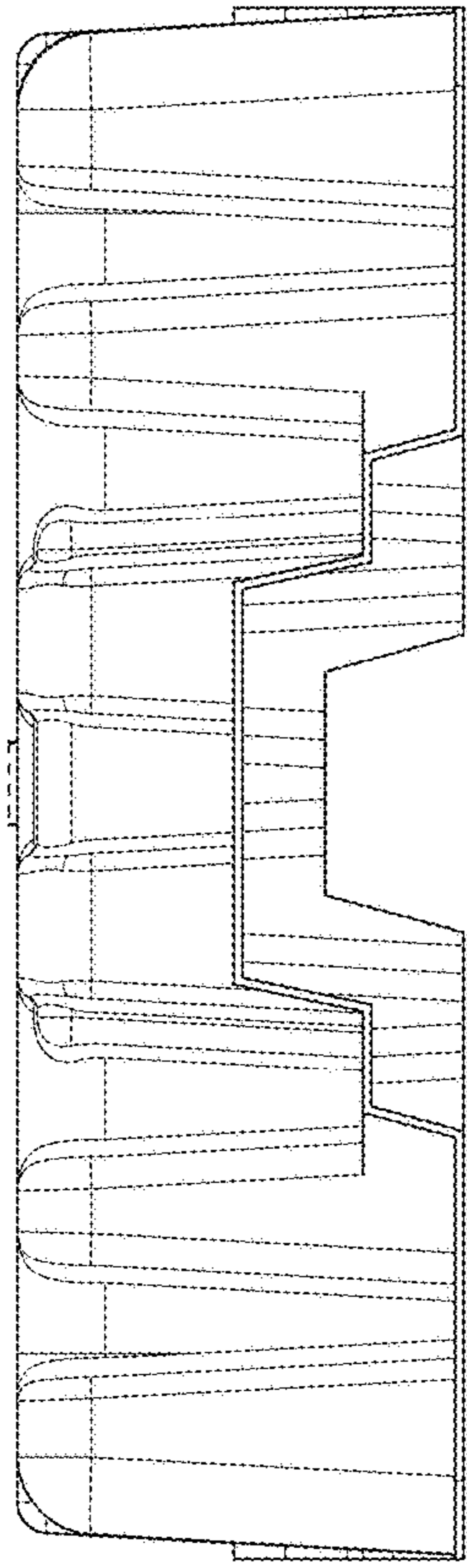

FIG. 25

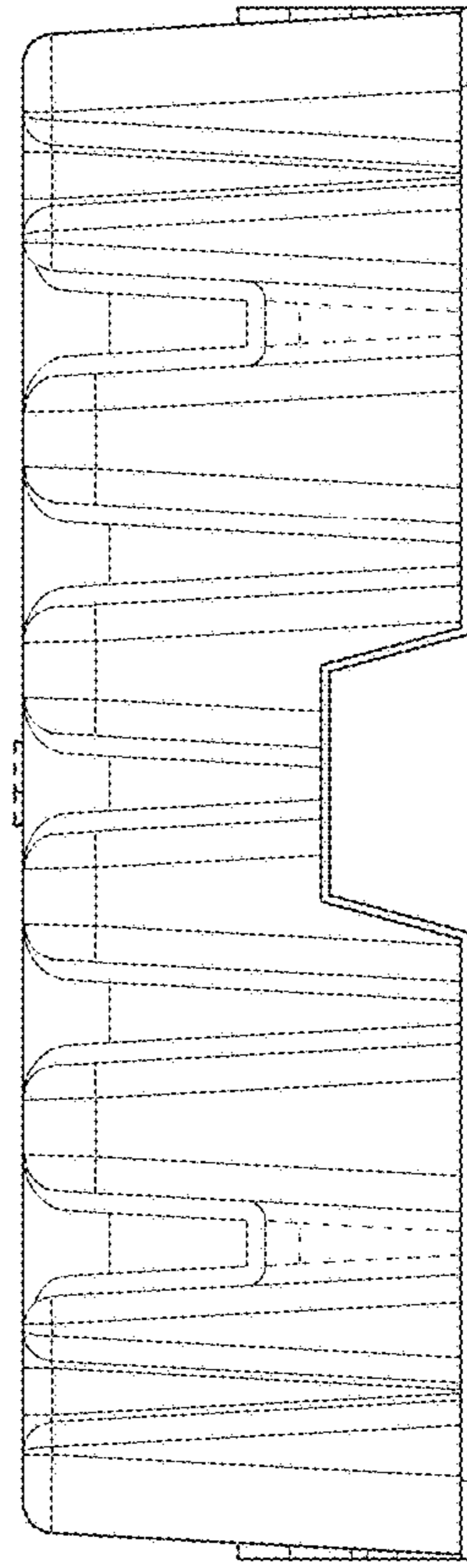

FIG. 26

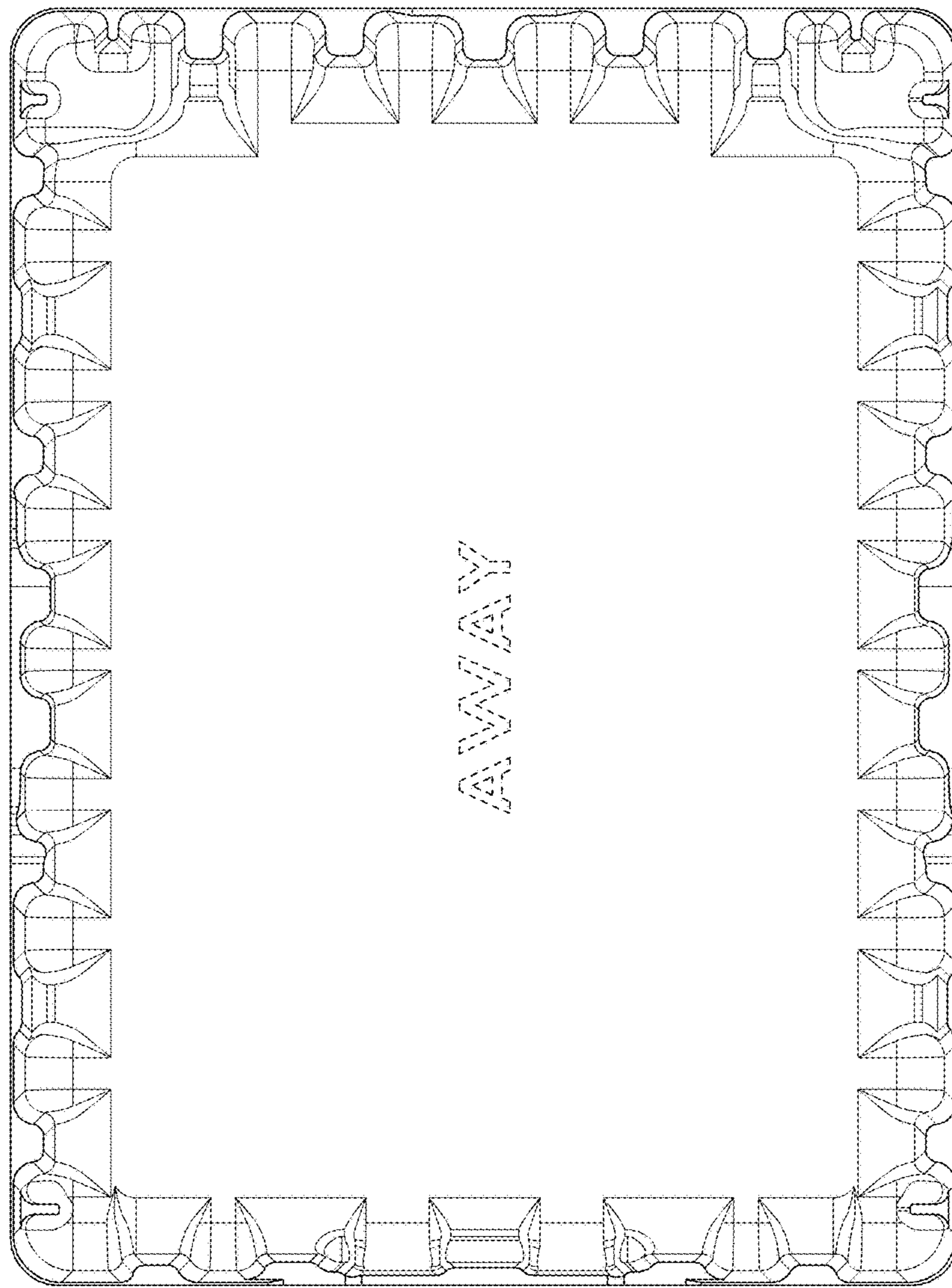

FIG. 27

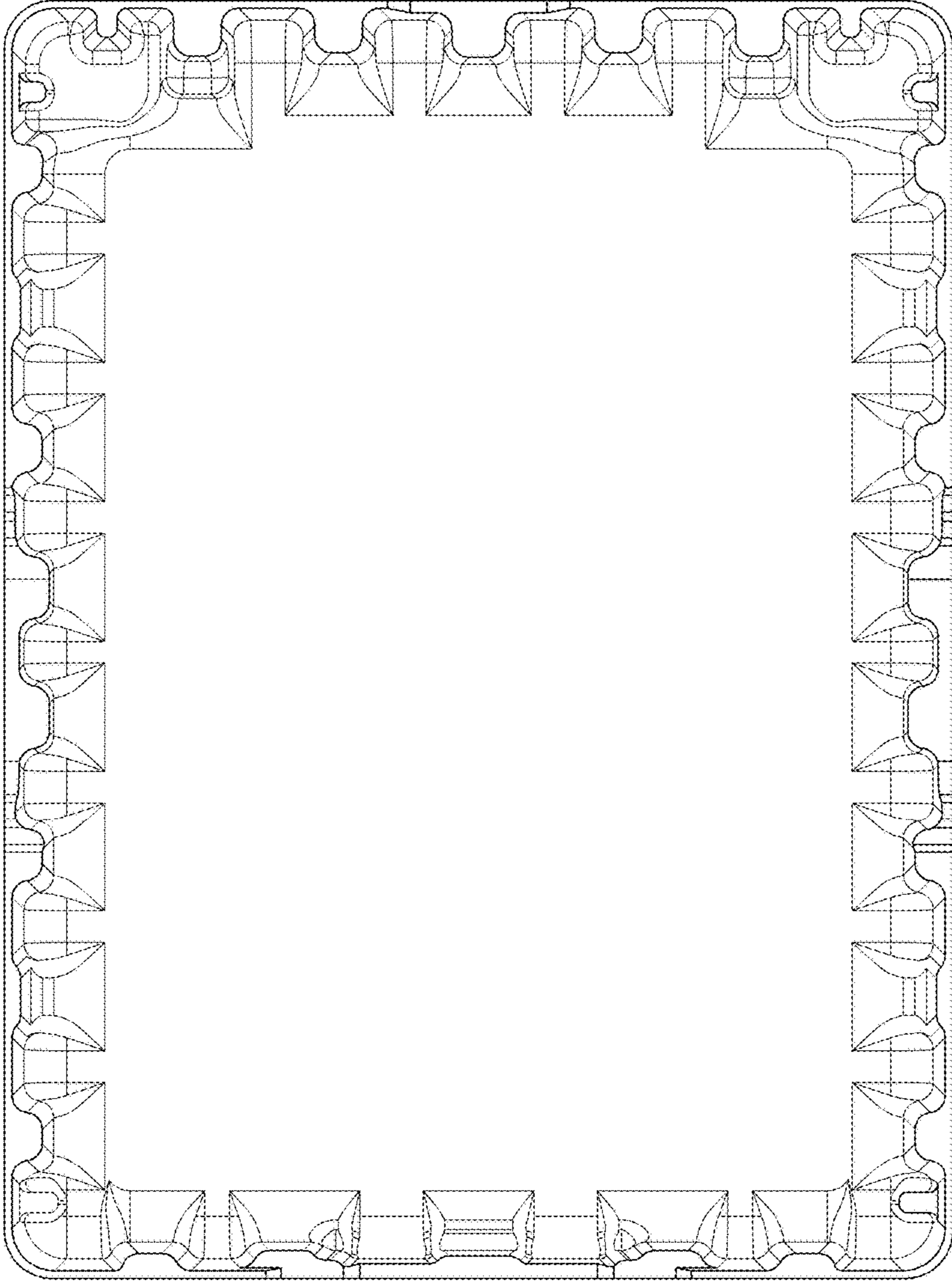

FIG. 28