

US00D867802S

(12) **United States Design Patent** (10) **Patent No.:** **US D867,802 S**
Demers (45) **Date of Patent:** **** Nov. 26, 2019**

(54) **BAKING DISH**
(71) Applicant: **Anchor Hocking, LLC**, Columbus, OH (US)
(72) Inventor: **Brian Joseph Demers**, Charlotte, NC (US)
(73) Assignee: **ANCHOR HOCKING, LLC**, Columbus, OH (US)

(**) Term: **15 Years**
(21) Appl. No.: **29/628,157**
(22) Filed: **Dec. 1, 2017**

(51) **LOC (12) Cl.** **07-02**
(52) **U.S. Cl.**
USPC **D7/354**

(58) **Field of Classification Search**
USPC D7/323, 354-361, 543, 545, 549, 550.1, D7/553.1-553.8, 554.1-554.4, 555, 652, D7/584, 586; D9/430-433, 455-456, D9/737, 756-762
CPC A21B 3/00; A21B 3/13; A21B 3/15; A21B 3/134; A21B 5/00; A21B 5/02; A47J 36/022; A47J 36/025; A47J 36/027; A47J 37/00; A47J 37/04; B65D 1/22; B65D 1/24; B65D 1/34; B65D 1/36; B65D 81/343; B65D 85/36

See application file for complete search history.

(56) **References Cited**

U.S. PATENT DOCUMENTS

D47,285 S * 5/1915 Ebeling D7/562
D63,039 S * 9/1923 Oldham D26/134
D116,790 S * 9/1939 Barbiers D19/70
D212,812 S * 11/1968 Benes D7/562
D215,745 S * 10/1969 Benes D7/562

D269,931 S * 8/1983 Durand D7/562
D418,017 S * 12/1999 Henry D7/545
D517,865 S * 3/2006 Rocha D7/562
D599,609 S * 9/2009 Ruffoni D7/354
D835,934 S * 12/2018 Demers D7/354
D835,935 S * 12/2018 Demers D7/354
D836,382 S * 12/2018 Demers D7/354
D842,641 S * 3/2019 Demers D7/354

OTHER PUBLICATIONS

Diamond Patterned Glass, Close up shot of the surface of a fancy glass bottle, downloaded Feb. 2, 2018 from <https://www.featurepics.com/online/Diamond-Patterned-Glass-Pictures199847.aspx>, dated 2007, 3 pgs.

(Continued)

Primary Examiner — Ricky Pham

(74) *Attorney, Agent, or Firm* — Tucker Ellis LLP; Carlos Garritano

(57) **CLAIM**

The ornamental design for a baking dish, as shown and described.

DESCRIPTION

FIG. 1 is a top perspective view of a baking dish showing the new design.

FIG. 2 is a front view thereof, the opposite rear view being a mirror image thereof.

FIG. 3 is a side view thereof, the opposite side view being a mirror image thereof.

FIG. 4 is a top view thereof.

FIG. 5 is a bottom view thereof.

FIG. 6 is a front cross section view taken along line 6-6 of FIG. 4; and,

FIG. 7 is a side cross section view taken along line 7-7 of FIG. 4.

1 Claim, 5 Drawing Sheets

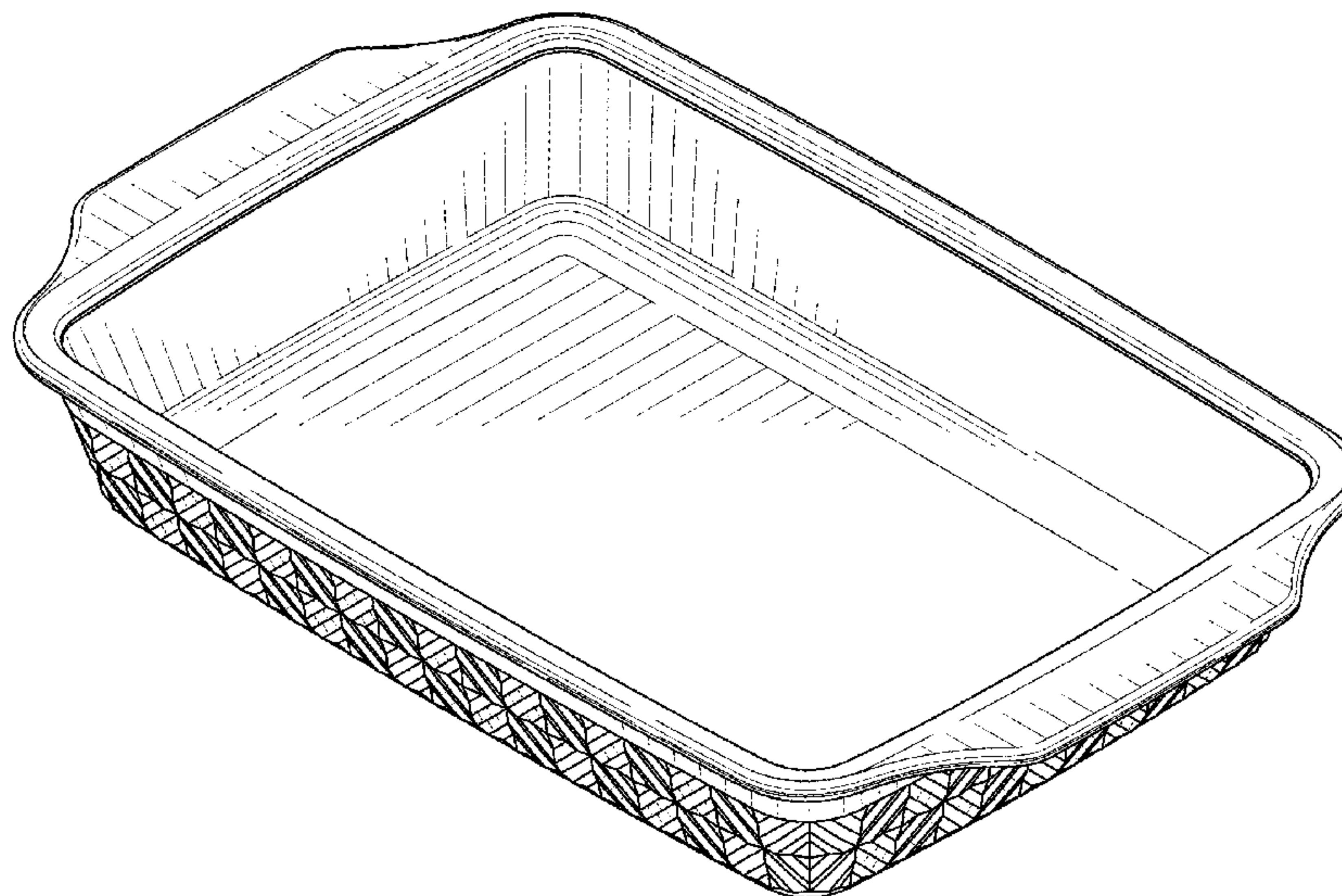

(56)

References Cited

OTHER PUBLICATIONS

Glass texture with a pattern of rhombuses. Clear glass diamond shape. Downloaded Feb. 2, 2018 from <https://www.dreamstime.com/stock-photo-glass-texture-pattern-rhombuses-clear-glass-diamond-shape-closeup-image64418056>, dated Oct. 2017, 3 pgs.

Pineapple Succulent Planter. Downloaded Feb. 2, 2018 from <http://www.doodlecraftblog.com/2017/03/pineapple-succulent-planter.html>, dated Mar. 20, 2017, 12 pgs.

Hatch Rocks Glass, by Crate and Barrel, downloaded Feb. 2, 2018 from <https://www.pinterest.com/pin/196821446191571421/?lp=true>, dated Oct. 2017, 1 pg.

* cited by examiner

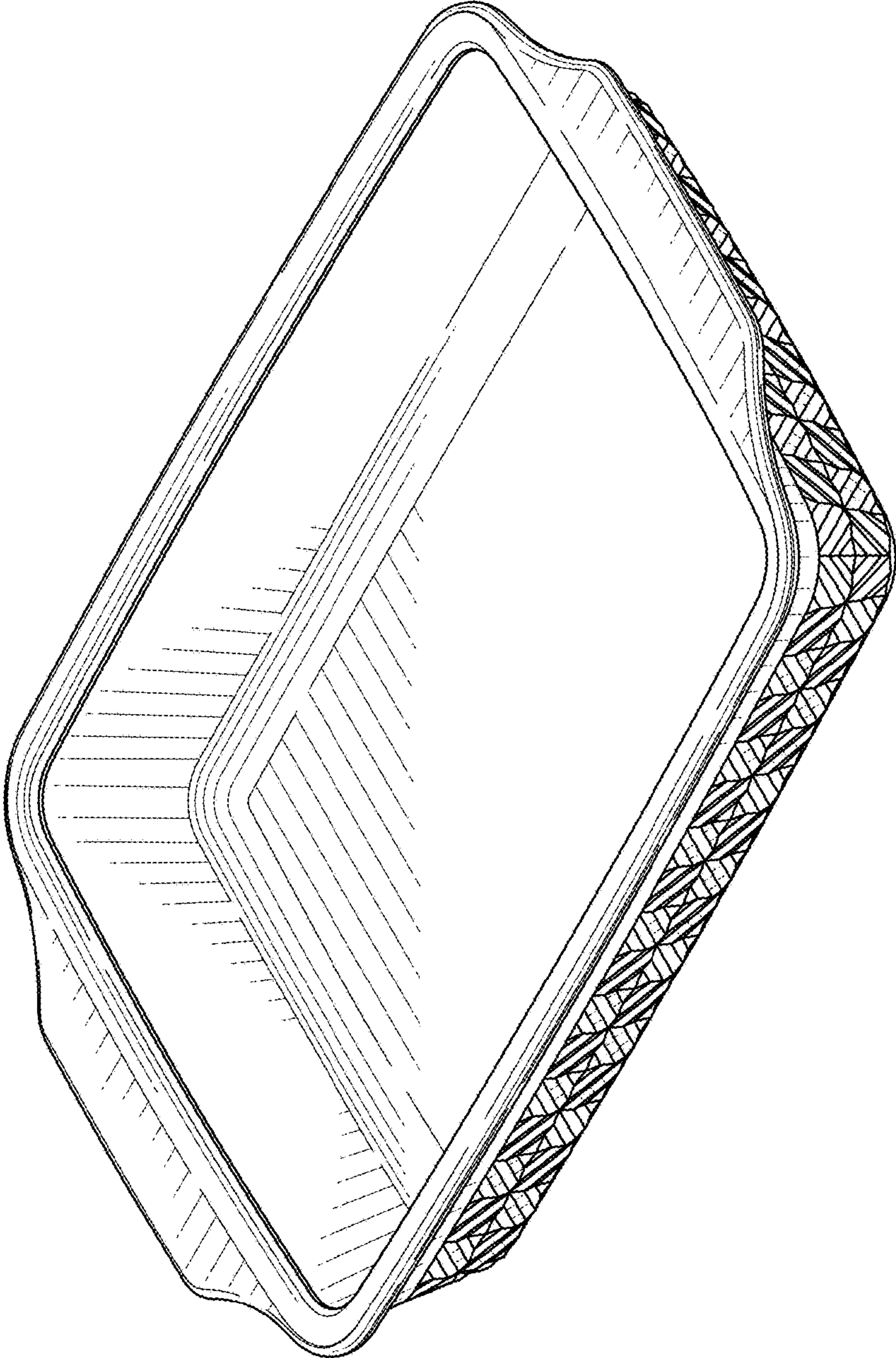

FIG. 1

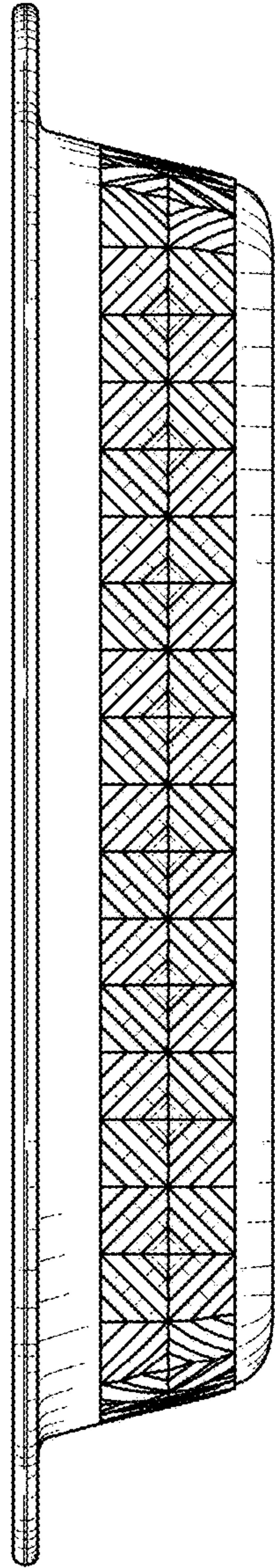

FIG. 2

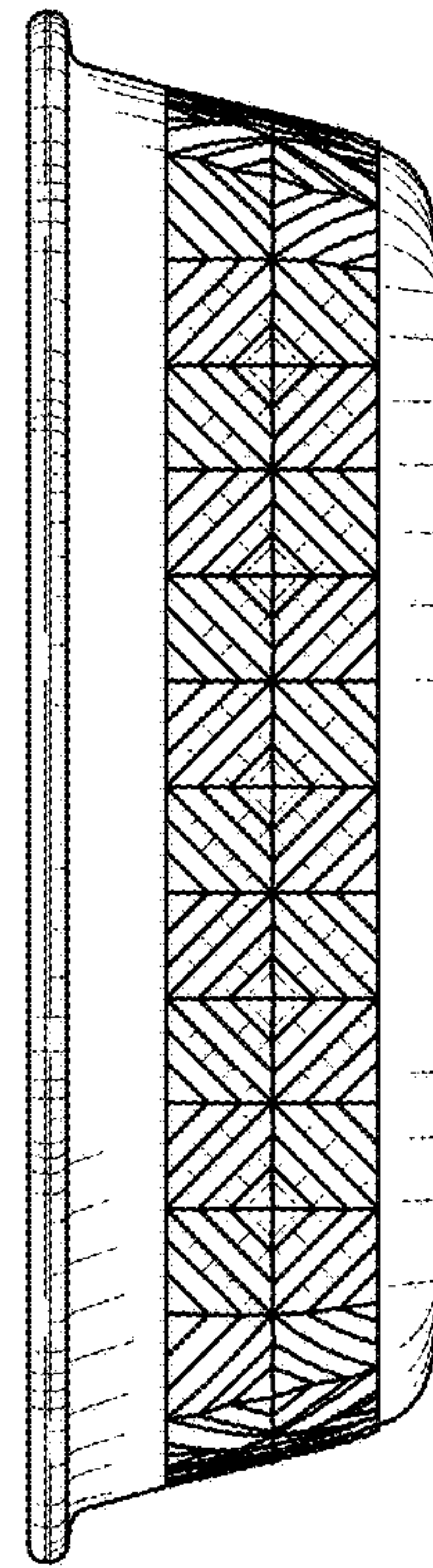

FIG. 3

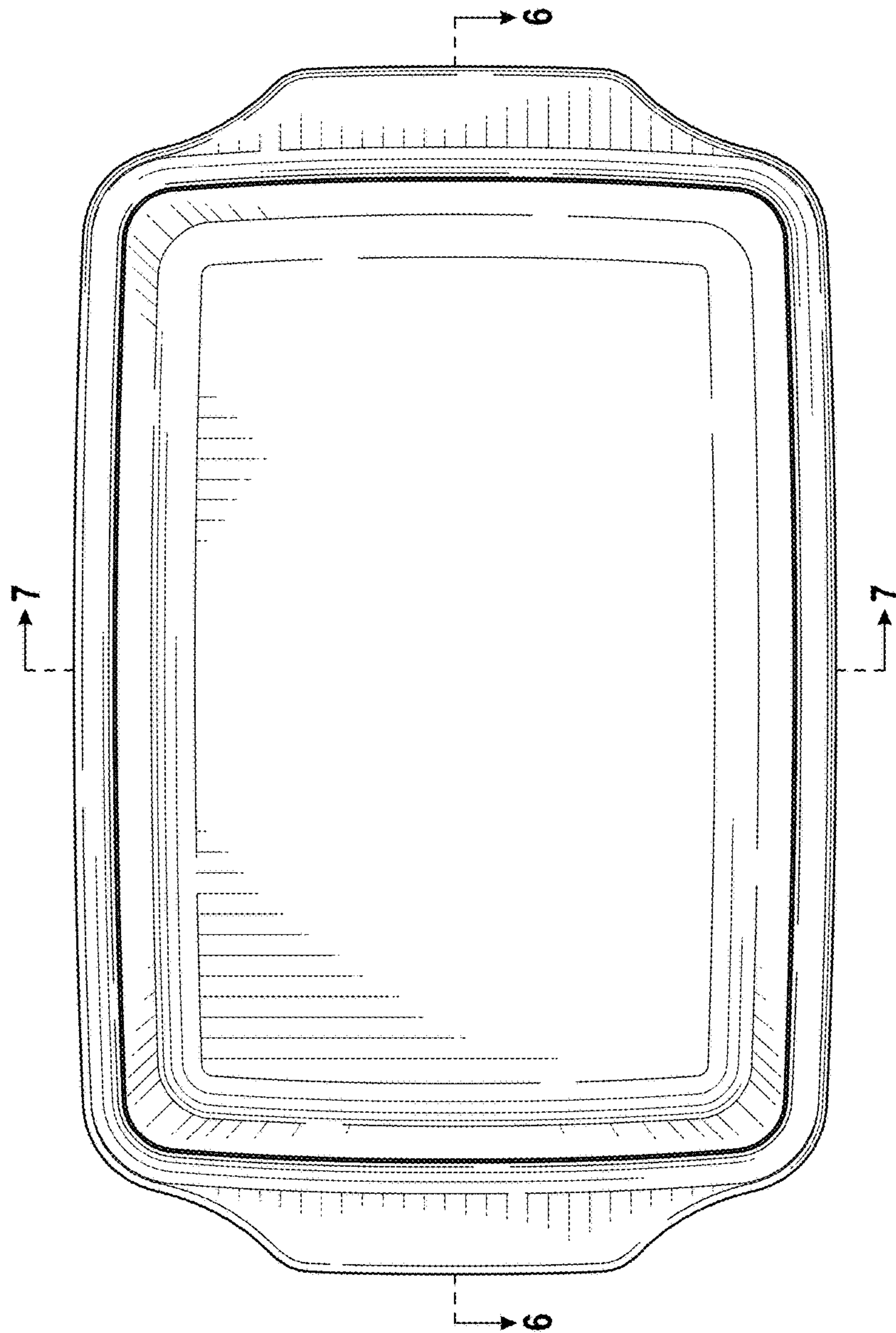

FIG. 4

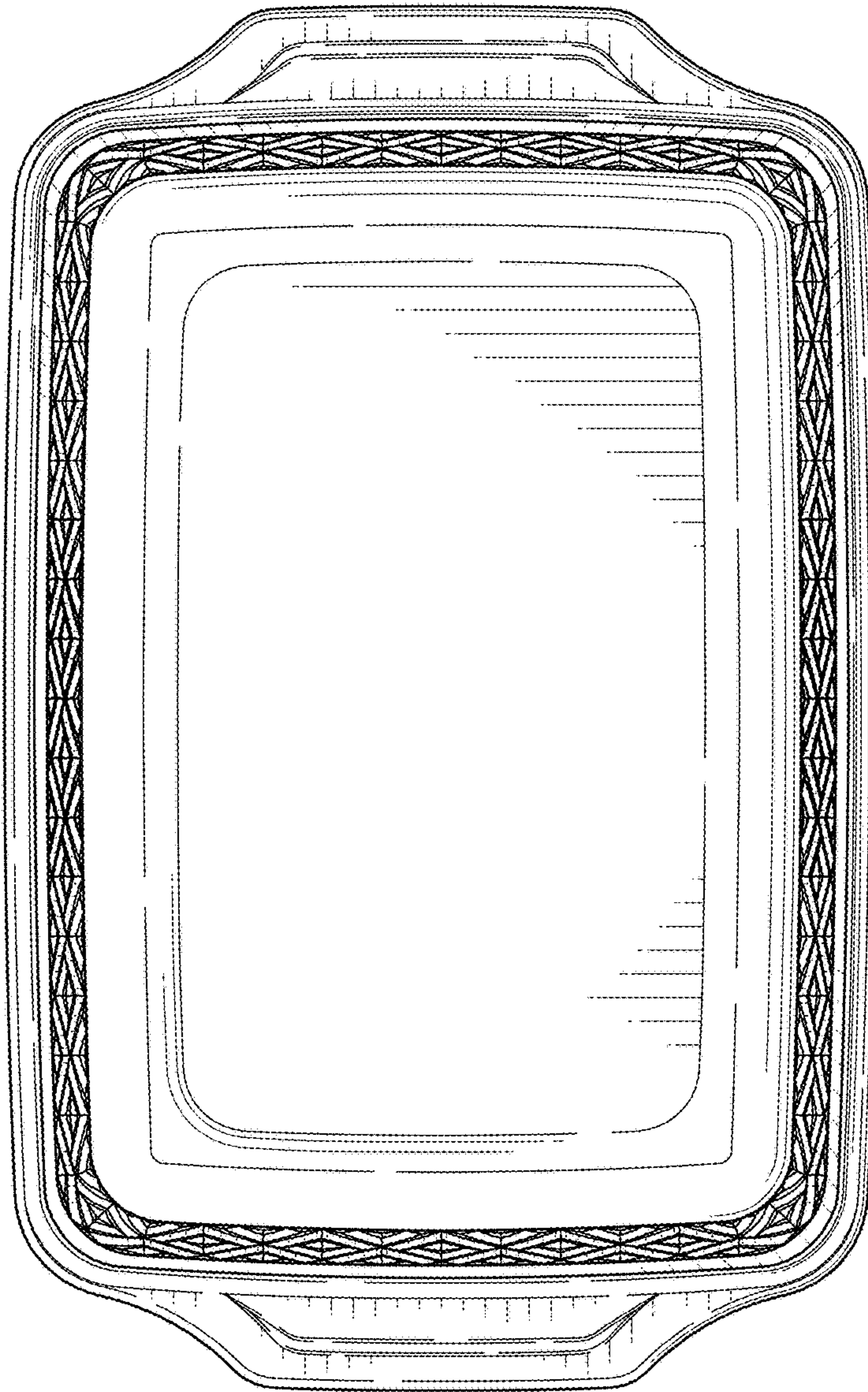

FIG. 5

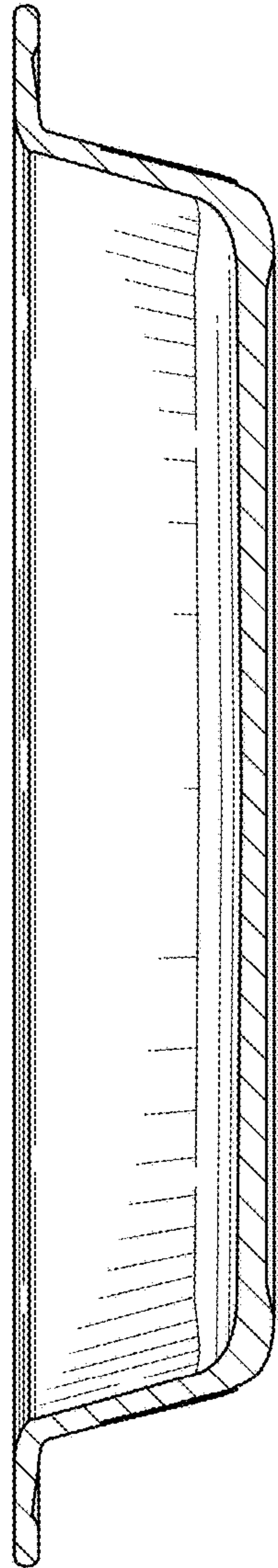

FIG. 6

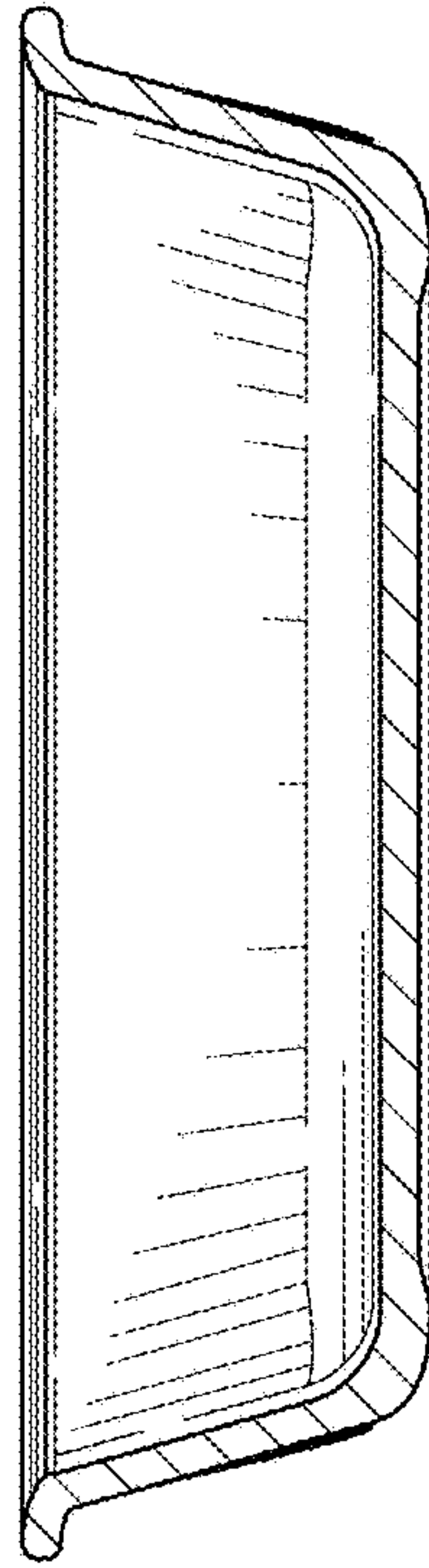

FIG. 7