



US00D867798S

(12) **United States Design Patent** (10) **Patent No.:** **US D867,798 S**  
**Clegg et al.** (45) **Date of Patent:** **\*\* Nov. 26, 2019**

(54) **CORNER OF A PANEL**

(74) *Attorney, Agent, or Firm* — Maschoff Brennan

(71) Applicant: **LIFETIME PRODUCTS, INC.**,  
Clearfield, UT (US)

(57) **CLAIM**

The ornamental design for a corner of a panel, as shown and described.

(72) Inventors: **Frank Clegg**, Fruit Heights, UT (US);  
**Jay Calkin**, Layton, UT (US)

**DESCRIPTION**

(73) Assignee: **Lifetime Products, Inc.**, Clearfield, UT (US)

FIG. 1 is a perspective view of a first embodiment of a corner of a panel in an environment of use;  
FIG. 2 is an enlarged detailed view of the boxed area 2 in FIG. 1;

(\*\*) Term: **15 Years**

FIG. 3 is a front view thereof;  
FIG. 4 is a right side view thereof;  
FIG. 5 is a top view thereof;

(21) Appl. No.: **29/643,502**

FIG. 6 is a bottom view thereof;

(22) Filed: **Apr. 9, 2018**

FIG. 7 is a perspective view of a second embodiment of a corner of a panel in an environment of use;

(51) **LOC (12) Cl.** ..... **06-06**

FIG. 8 is an enlarged detailed view of the boxed area 8 in FIG. 7;

(52) **U.S. Cl.**

USPC ..... **D6/707.26**

FIG. 9 is a front view thereof;

(58) **Field of Classification Search**

USPC ..... D6/641, 657, 685, 686, 689, 690, 691,  
D6/691.1, 691.2, 691.3, 691.4, 691.5,  
(Continued)

FIG. 10 is a right side view thereof;

FIG. 11 is a top view thereof;

FIG. 12 is a bottom view thereof;

FIG. 13 is a perspective view of a third embodiment of a corner of a panel in an environment of use;

(56) **References Cited**

**U.S. PATENT DOCUMENTS**

D333,607 S \* 3/1993 Isler ..... D12/414  
D487,205 S \* 3/2004 Mower ..... D6/707.26  
(Continued)

FIG. 14 is an enlarged detailed view of the boxed area 13 in FIG. 13;

FIG. 15 is a front view thereof;

FIG. 16 is a right side view thereof;

FIG. 17 is a top view thereof;

FIG. 18 is a bottom view thereof;

FIG. 19 is a perspective view of a fourth embodiment of a corner of a panel in an environment of use;

**OTHER PUBLICATIONS**

Folding Table, posted at Lifetime.com, posted on Jan. 14, 2017, site visited Apr. 10, 2019. online, available from internet: <https://web.archive.org/web/20170114221435/http://www.lifetime.com/miscellaneous-tables> (Year: 2017).\*

FIG. 20 is an enlarged detailed view of the boxed area 20 in FIG. 19;

FIG. 21 is a front view thereof;

FIG. 22 is a right side view thereof;

FIG. 23 is a top view thereof; and,

FIG. 24 is a bottom view thereof.

All broken line portions of the figures are included to show environments and form no part of the claimed design.

*Primary Examiner* — Mary Ann Calabrese  
*Assistant Examiner* — Catherine Ho

**1 Claim, 20 Drawing Sheets**

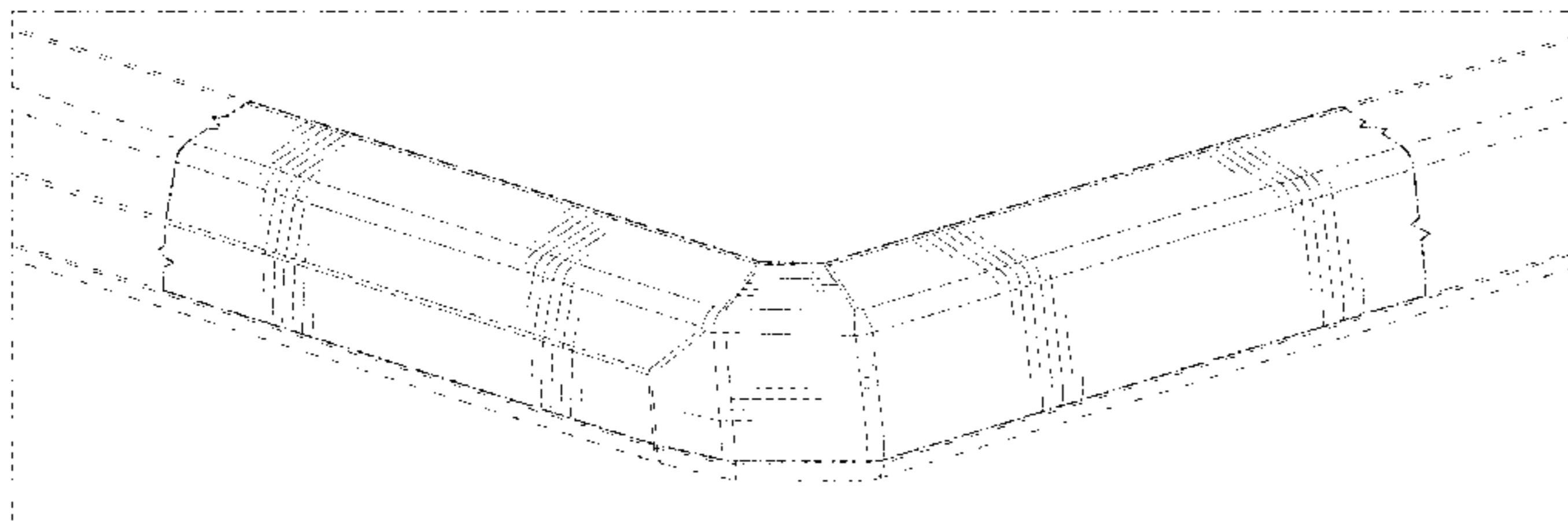

(58) **Field of Classification Search**

USPC ..... D6/691.6, 691.7, 691.8, 691.9, 699,  
D6/699.1, 699.2, 699.3, 699.4, 699.5,  
D6/702, 707, 707.15, 707.19, 707.23,  
D6/707.24, 707.26, 708, 709, 709.17,  
D6/709.2, 709.21, 709.22, 711; D21/397,  
D21/783, 799.2  
CPC .. A47B 37/00; A47B 3/00; A47B 1/00; A47B  
3/06; A47B 3/08; A47B 7/00; A47B  
21/00; A47B 23/00; A47B 25/00; A47B  
13/08; A47B 3/083; A47B 3/14; A47B  
41/00; A47B 17/00; A47B 3/0809; A47B  
3/0812; A47B 2013/026; A47B 2200/03;  
A47B 2200/00; A47B 2003/0821; A47C  
3/045

See application file for complete search history.

(56) **References Cited**

U.S. PATENT DOCUMENTS

D498,622 S \* 11/2004 Neunzert ..... D6/707  
D583,173 S \* 12/2008 Hazelwood ..... D6/707  
7,975,625 B2 \* 7/2011 Topham ..... A47B 3/0803  
108/115  
8,622,007 B2 \* 1/2014 Peery ..... A47B 13/08  
108/132  
D700,465 S \* 3/2014 Johnson ..... D6/707.19  
D714,411 S \* 9/2014 Chen ..... D21/799.2  
9,486,076 B2 \* 11/2016 Peery ..... A47B 7/02  
D805,822 S \* 12/2017 Baldoni ..... D6/707.24  
D836,726 S \* 12/2018 Wasserman ..... D21/397  
2016/0227918 A1 \* 8/2016 Turner ..... A47B 3/087  
2017/0238708 A1 \* 8/2017 Peery ..... A47B 3/0912

\* cited by examiner

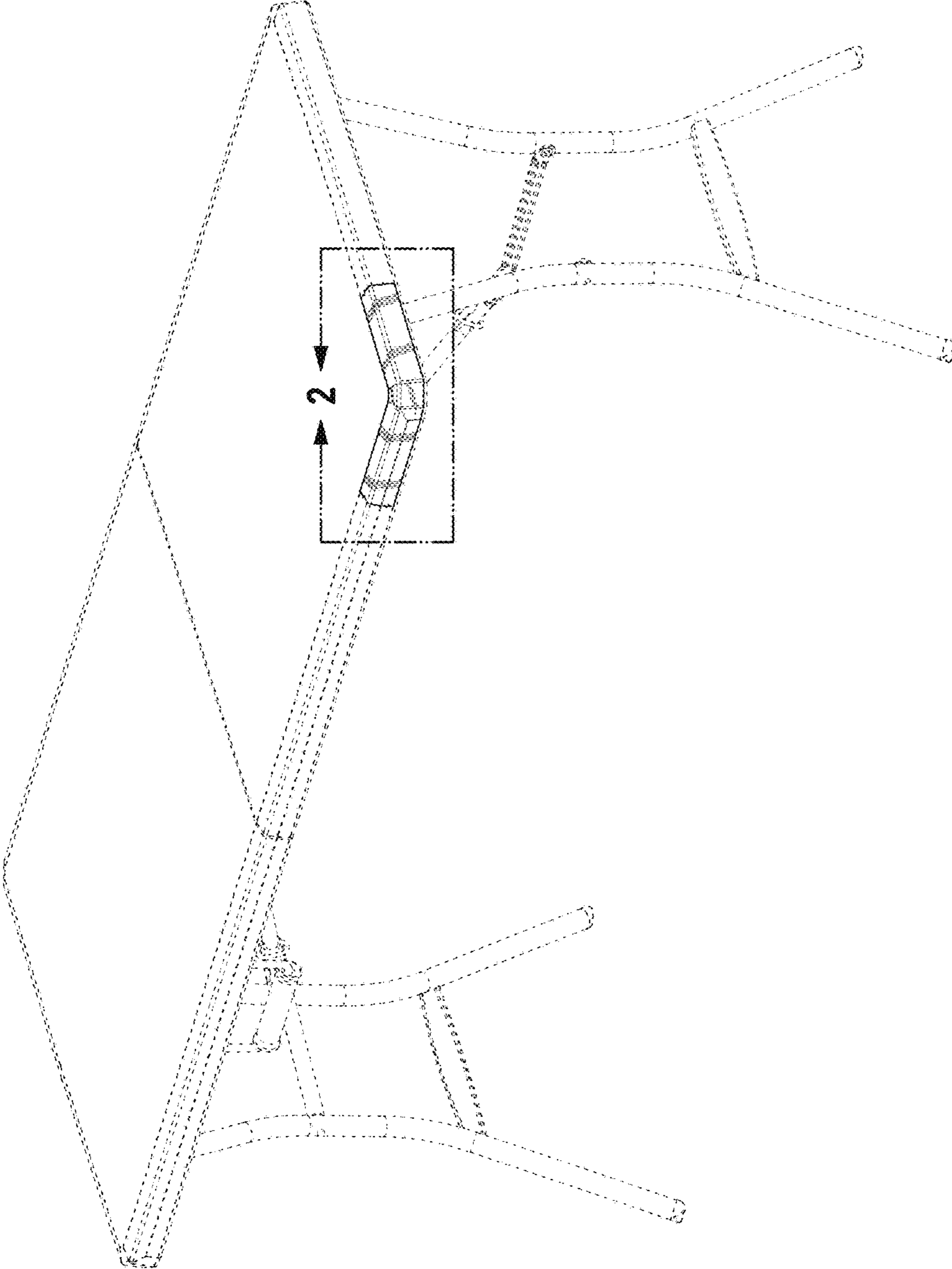

FIG. 1

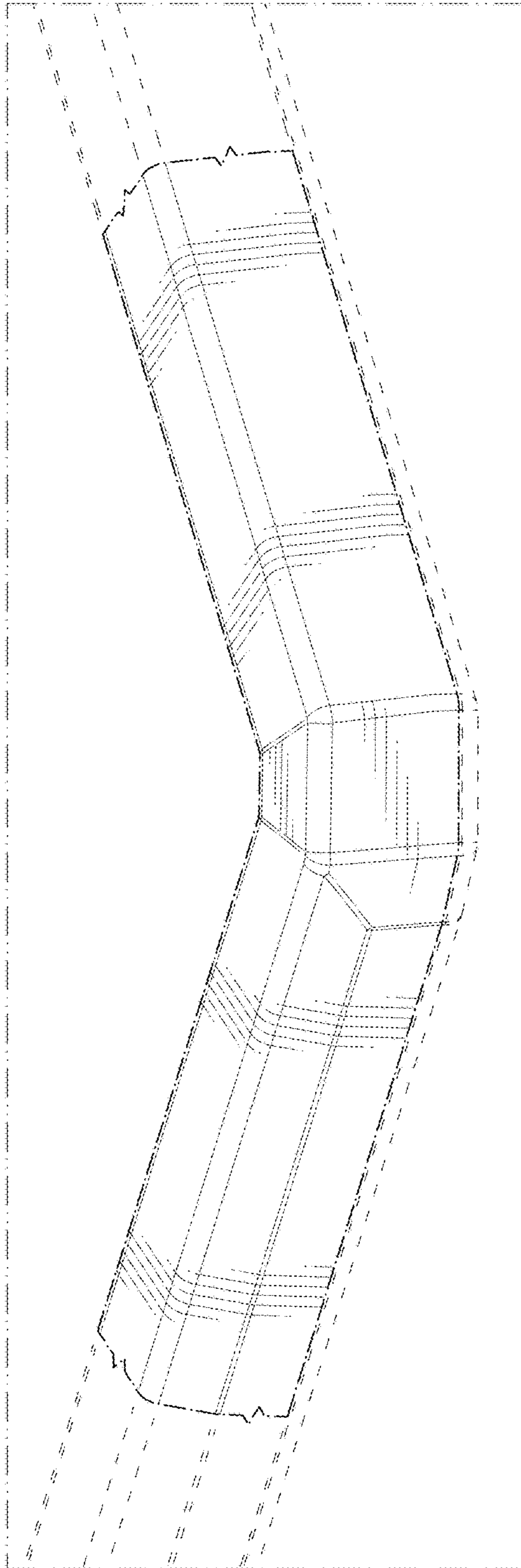

FIG. 2

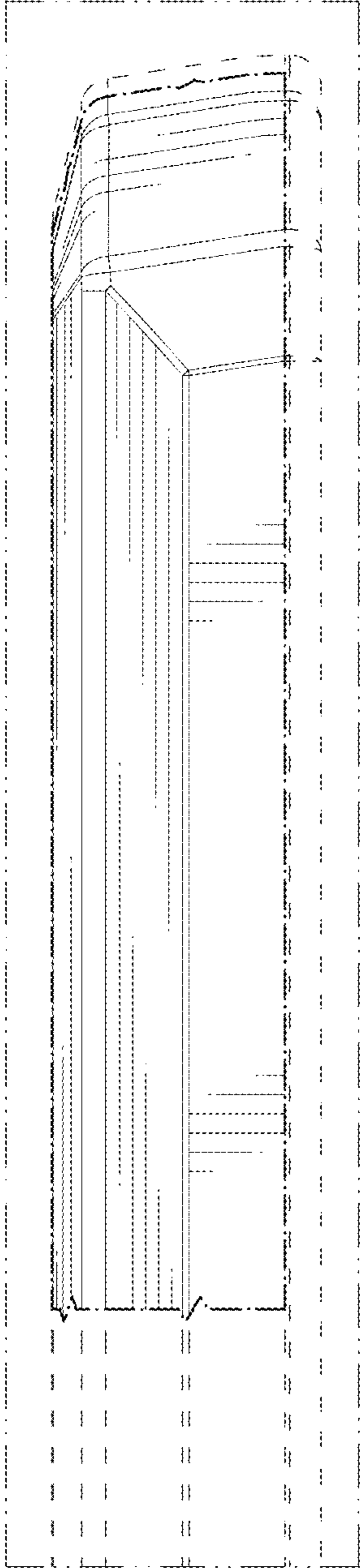

FIG. 3

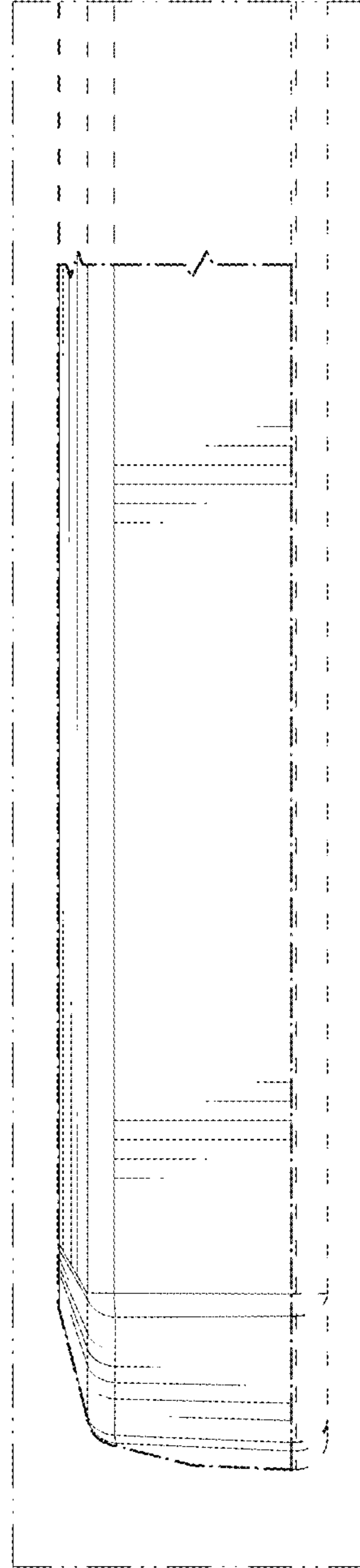

FIG. 4

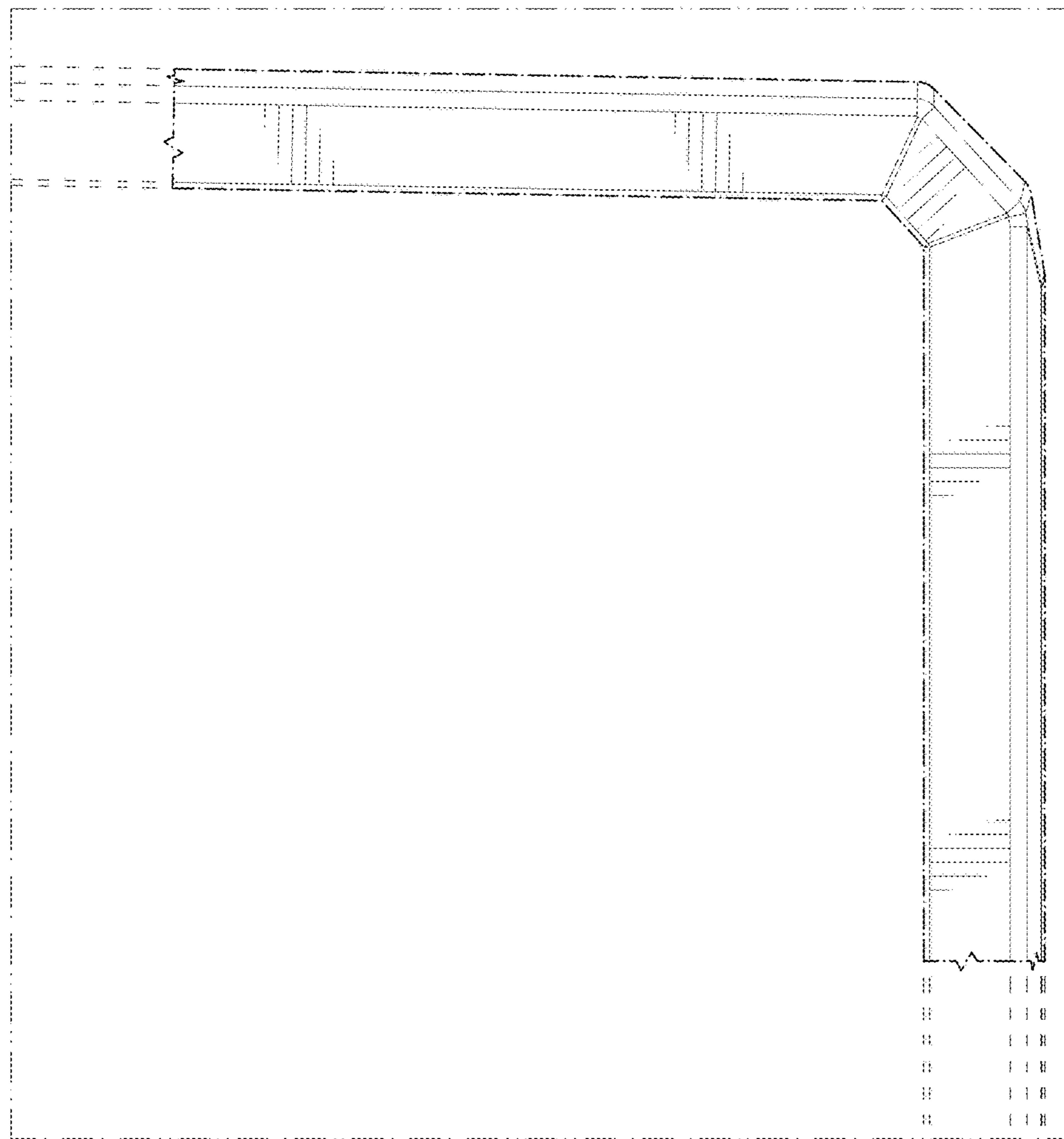

FIG. 5

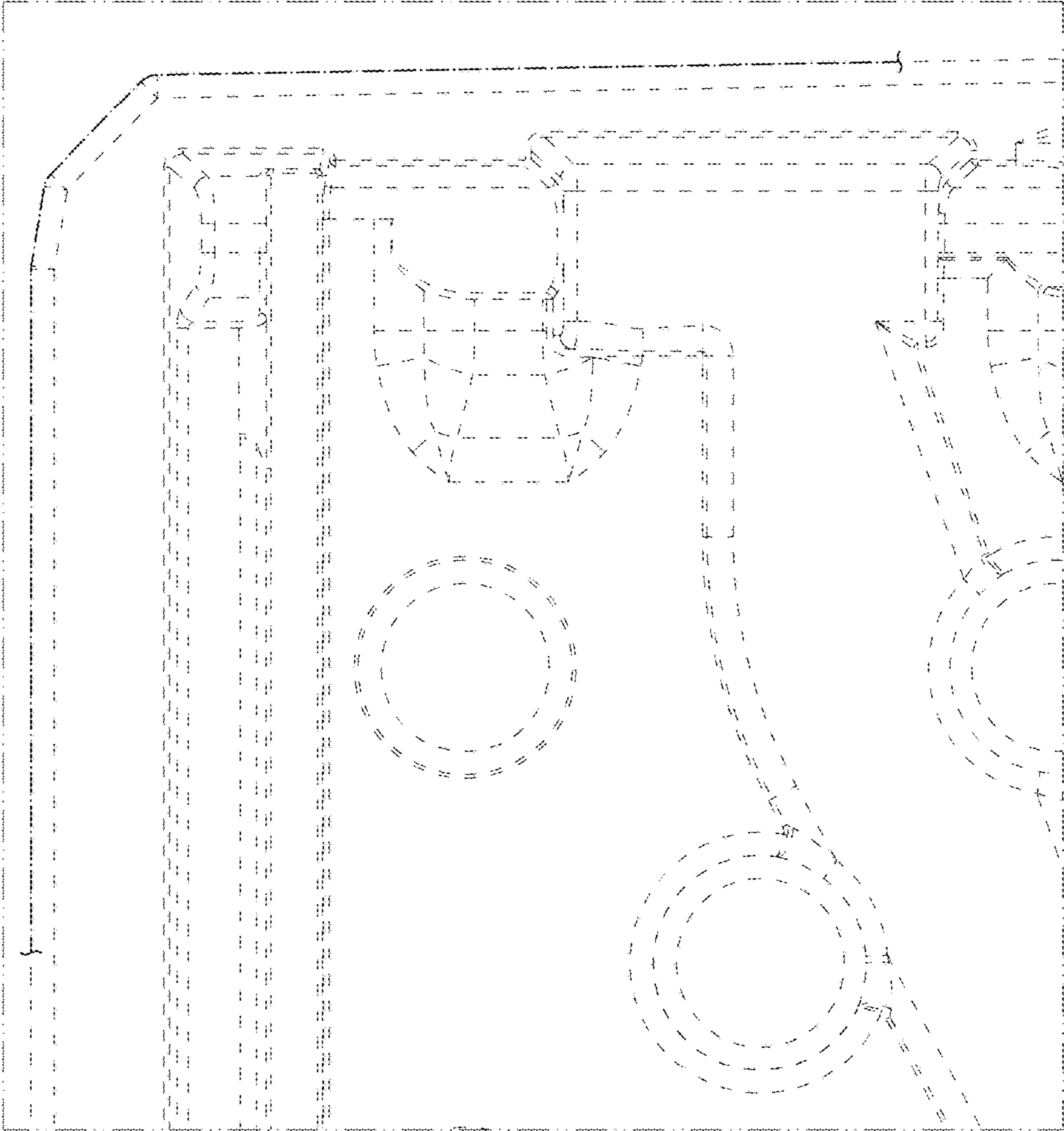

FIG. 6

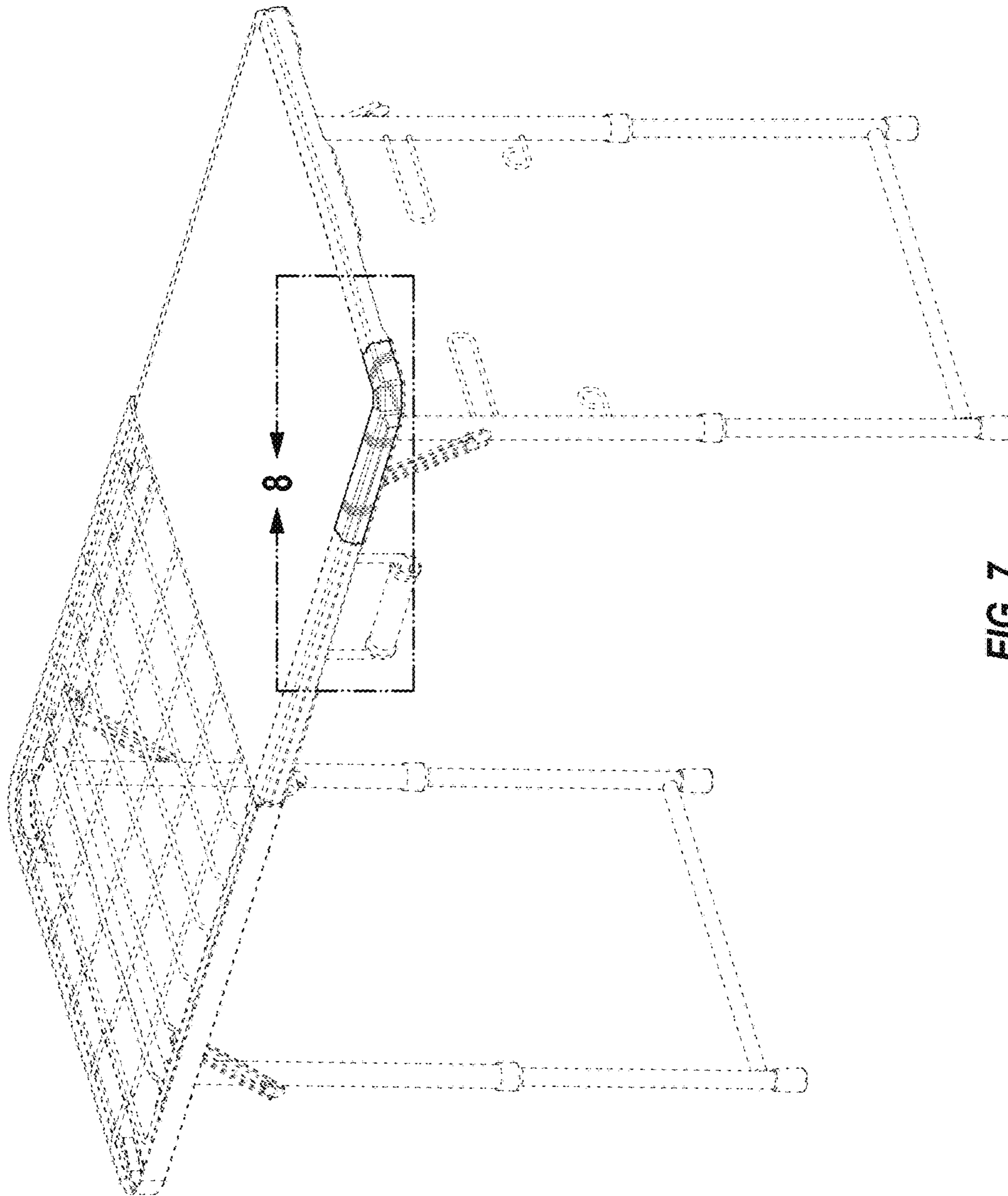

FIG. 7



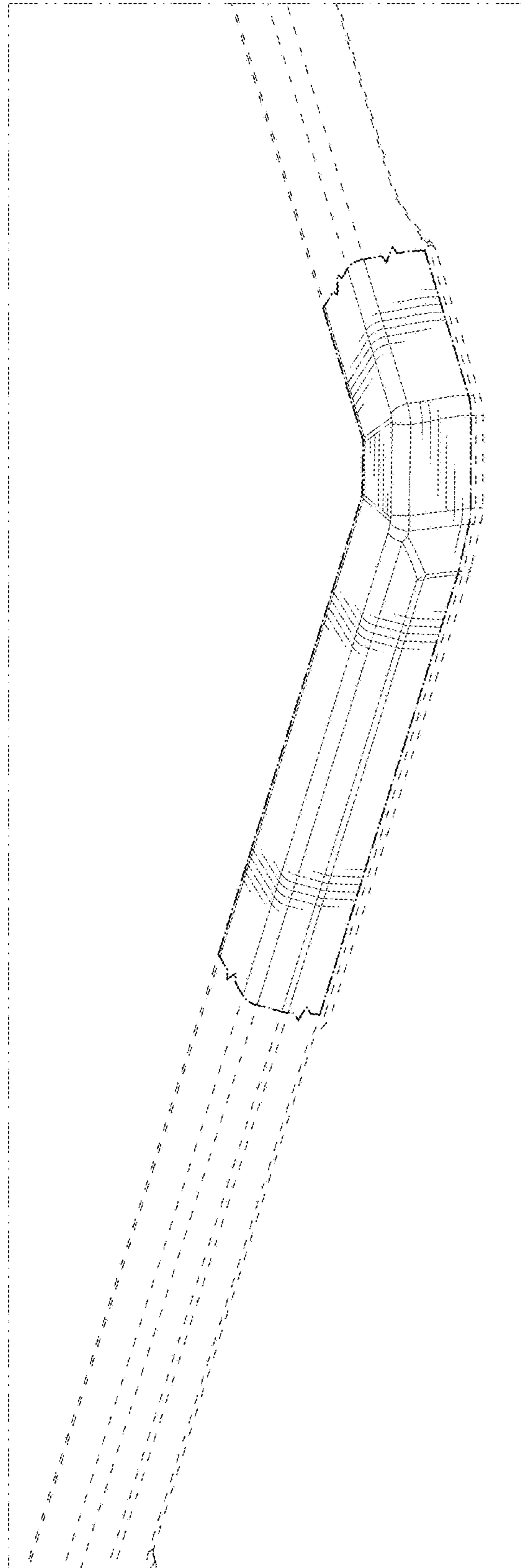

FIG. 8

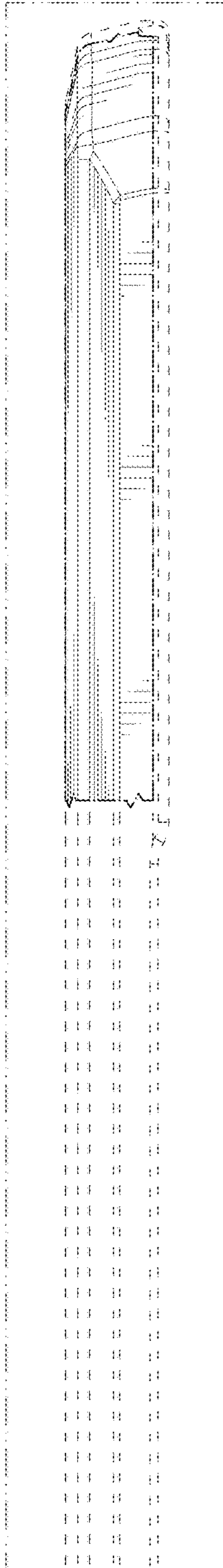

FIG. 9

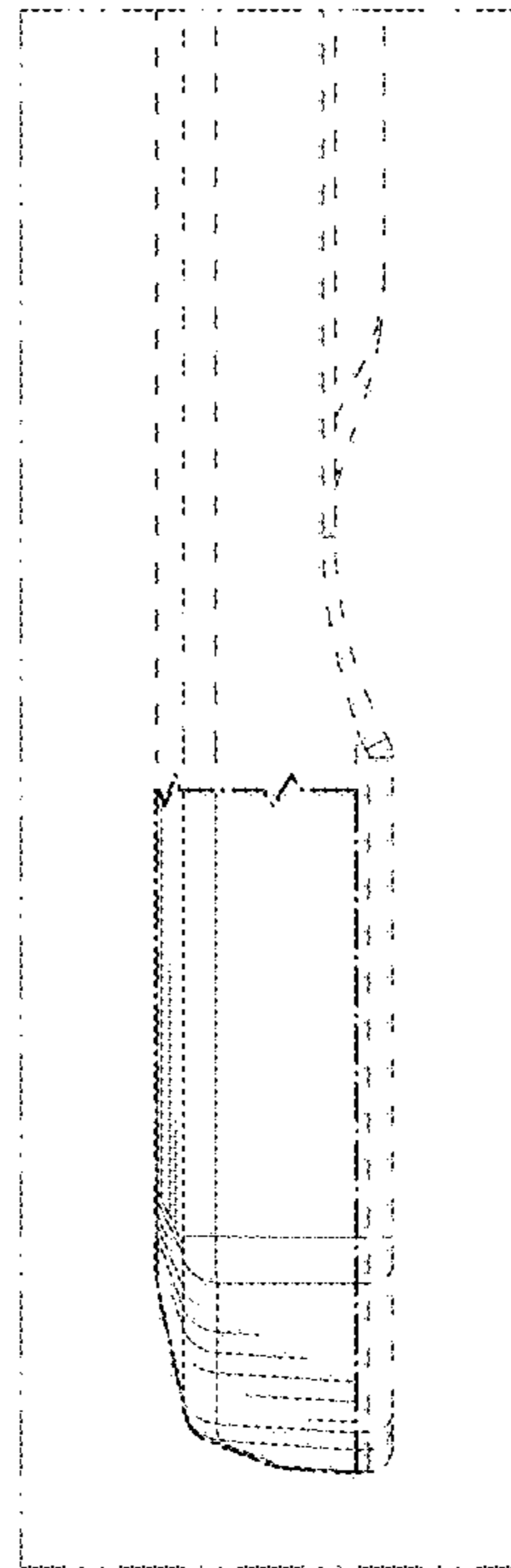

FIG. 10

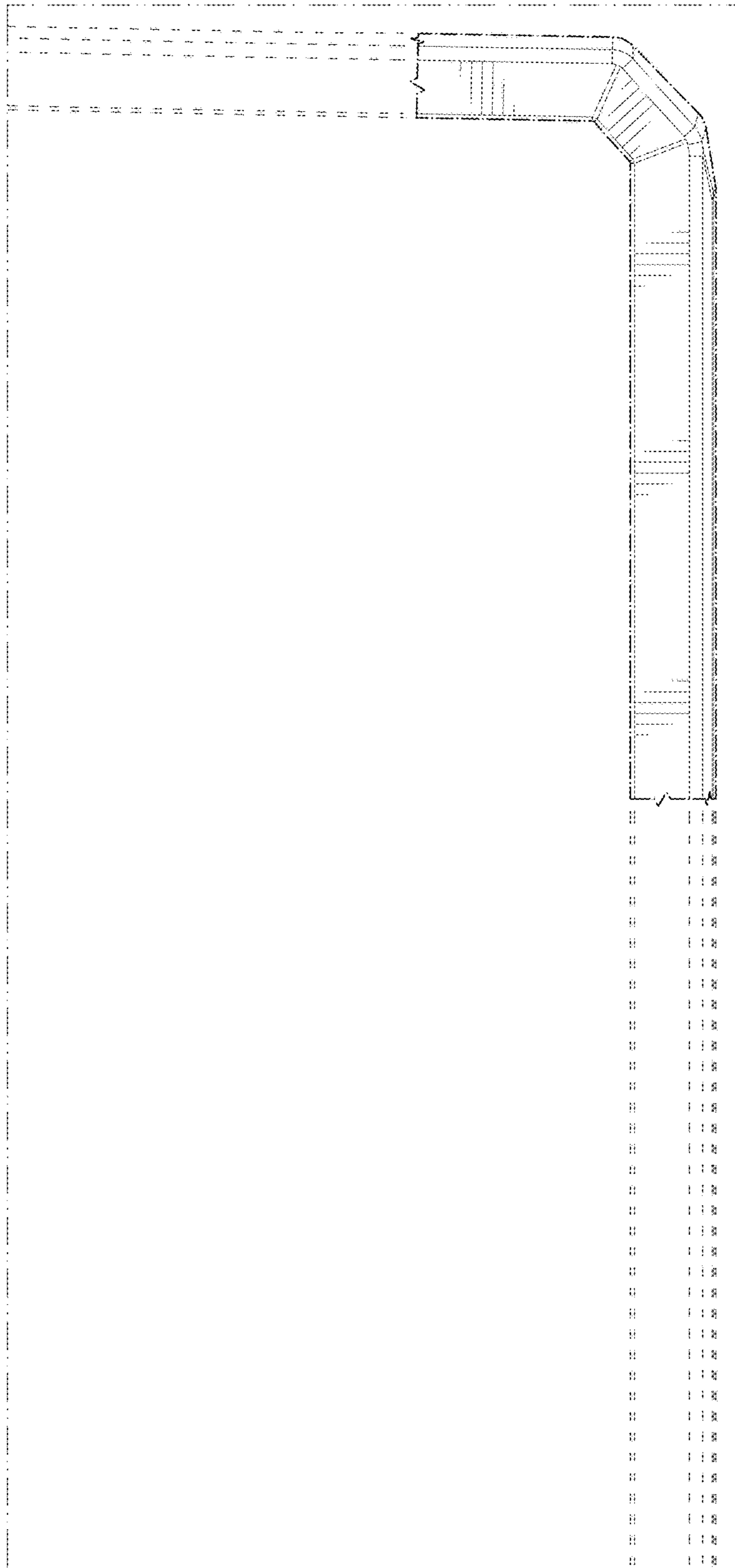

FIG. 11

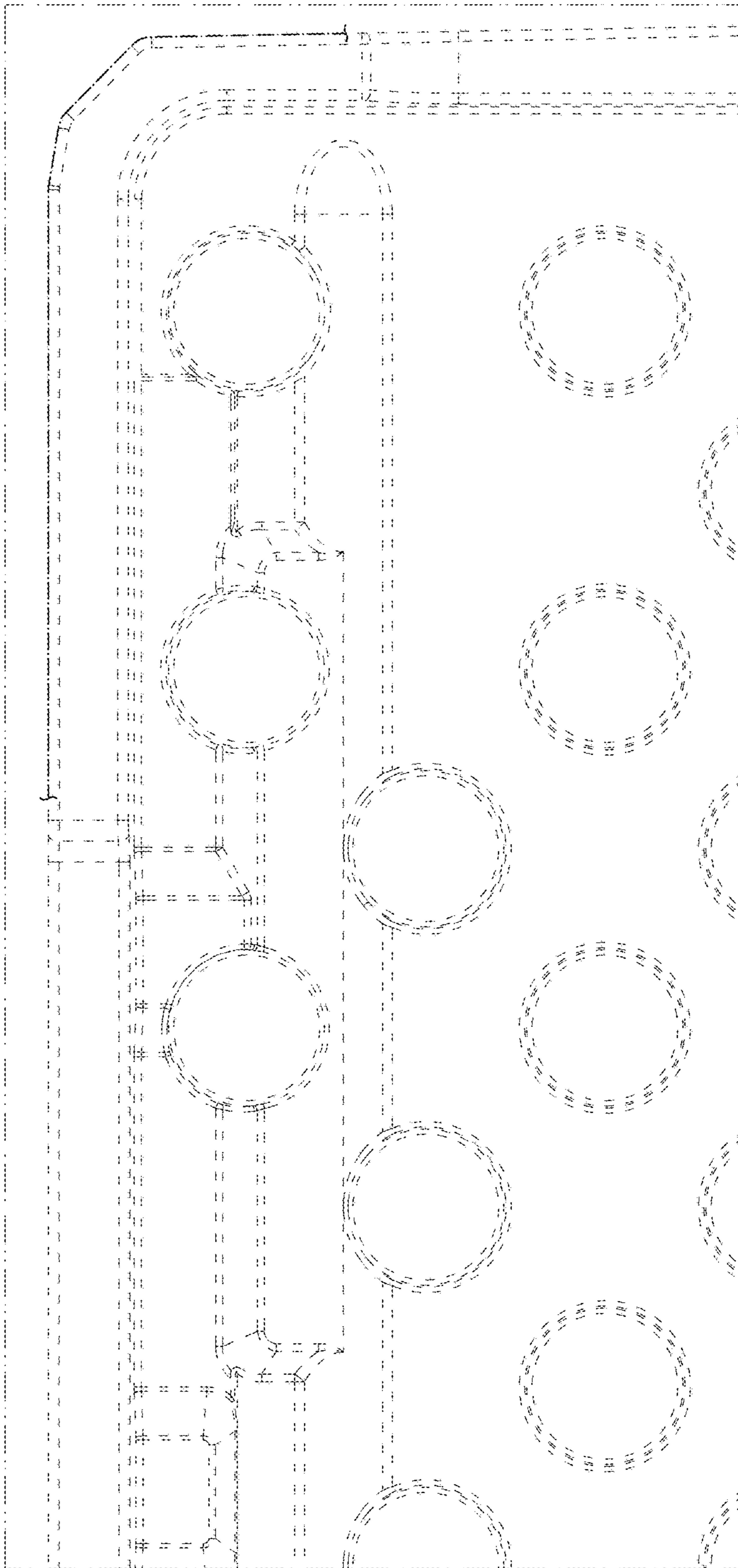

FIG. 12

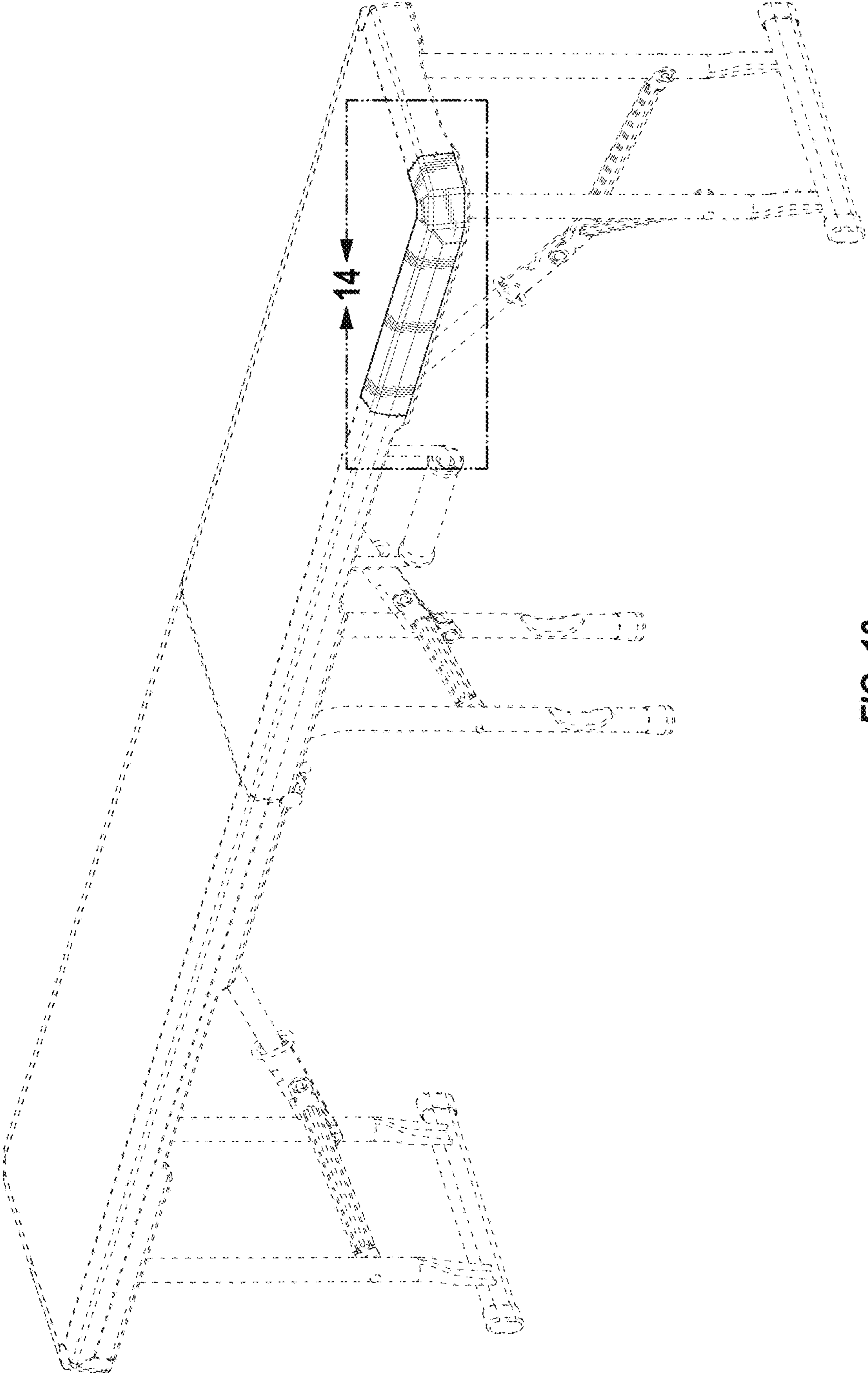

FIG. 13

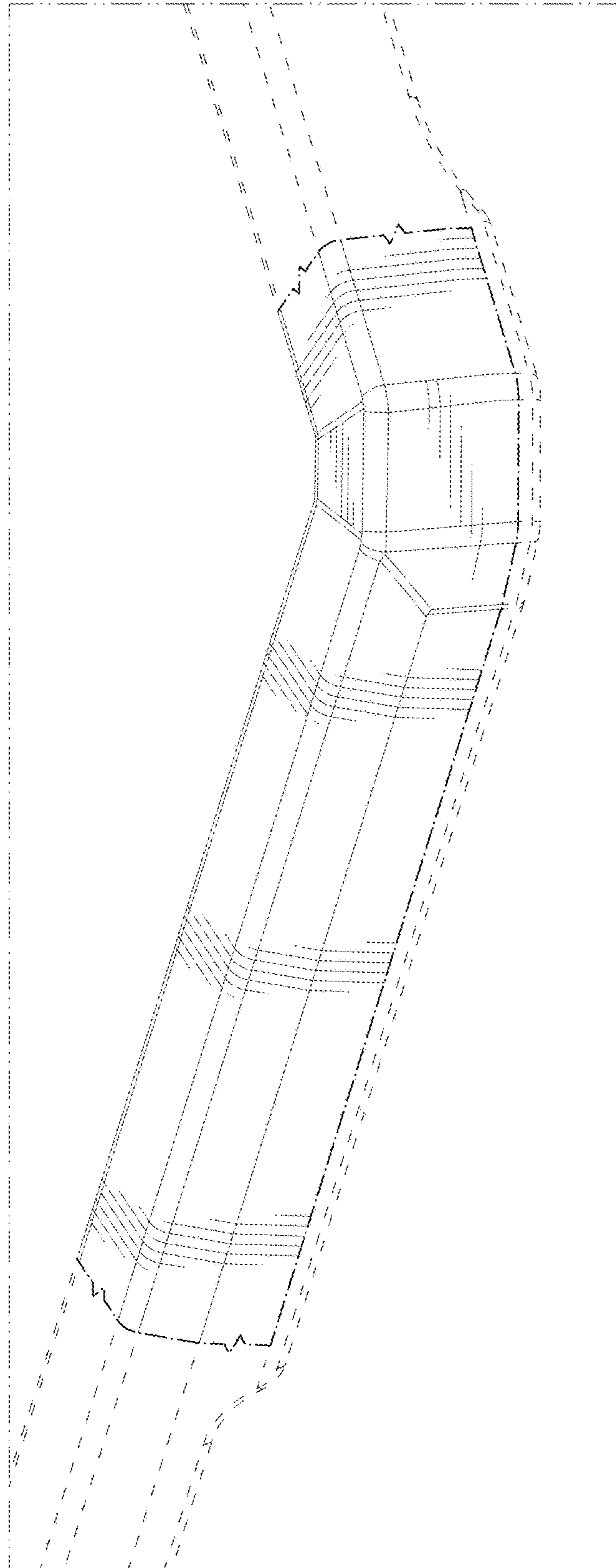

FIG. 14

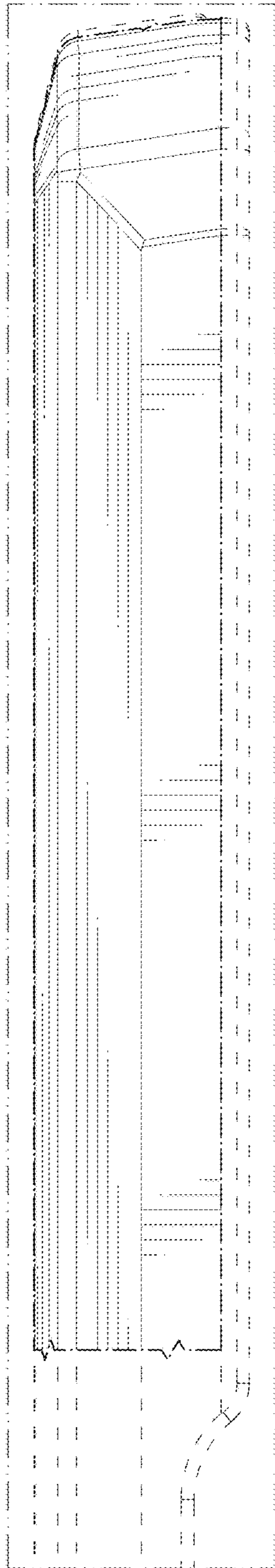

FIG. 15

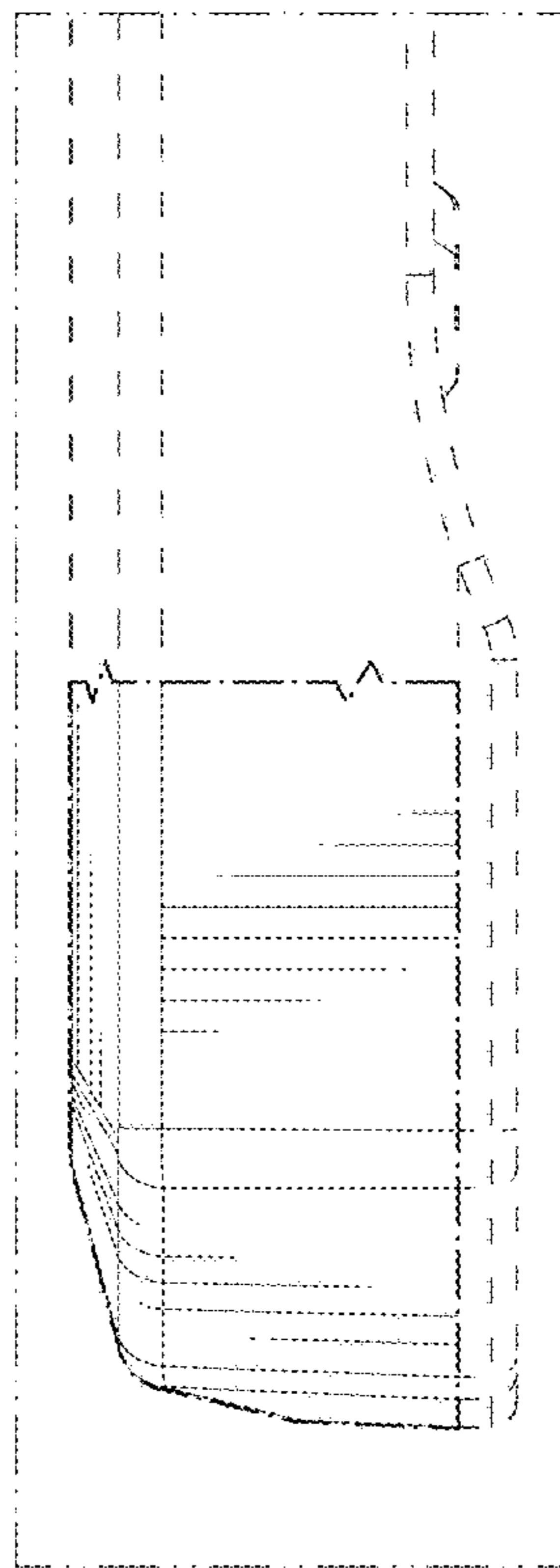

FIG. 16

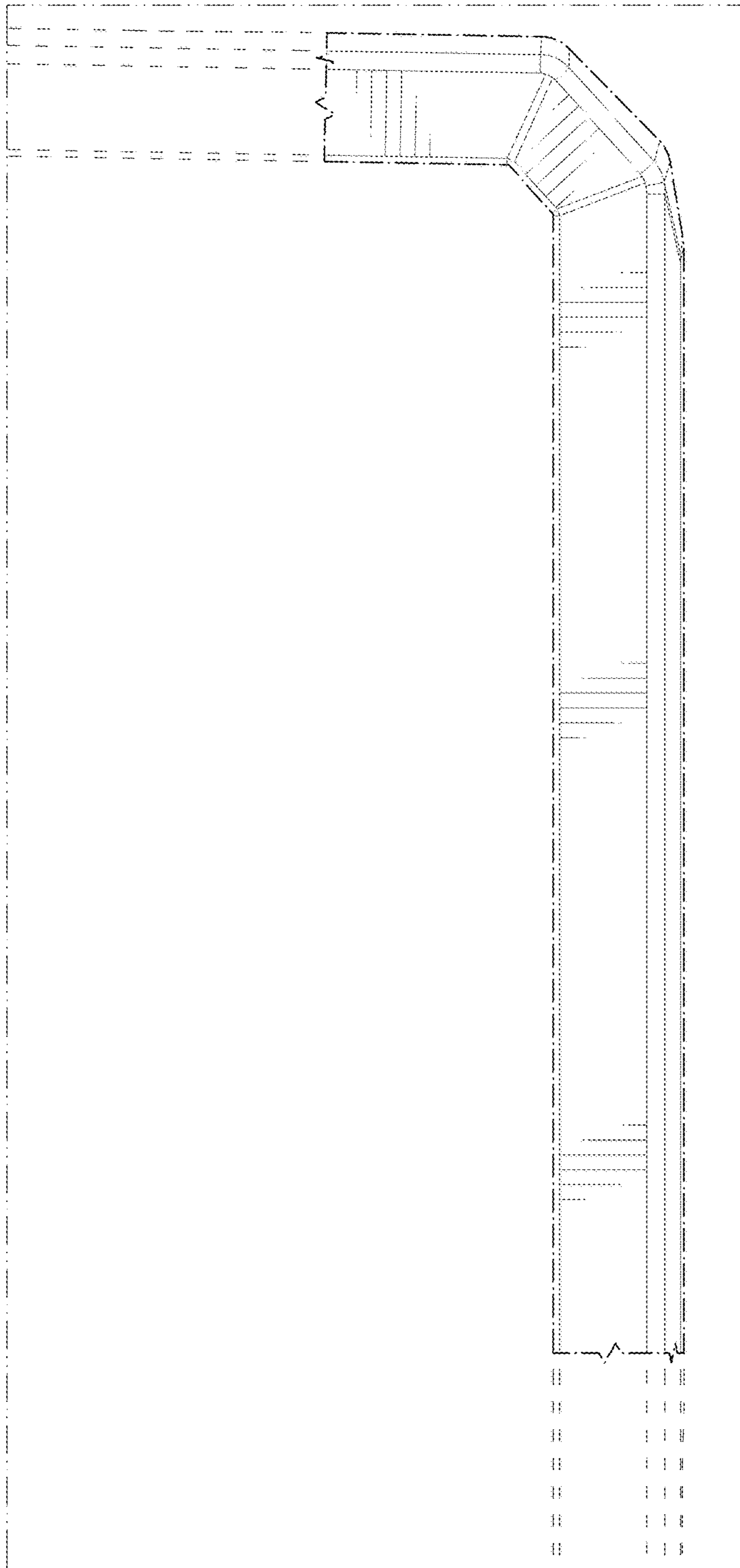

FIG. 17



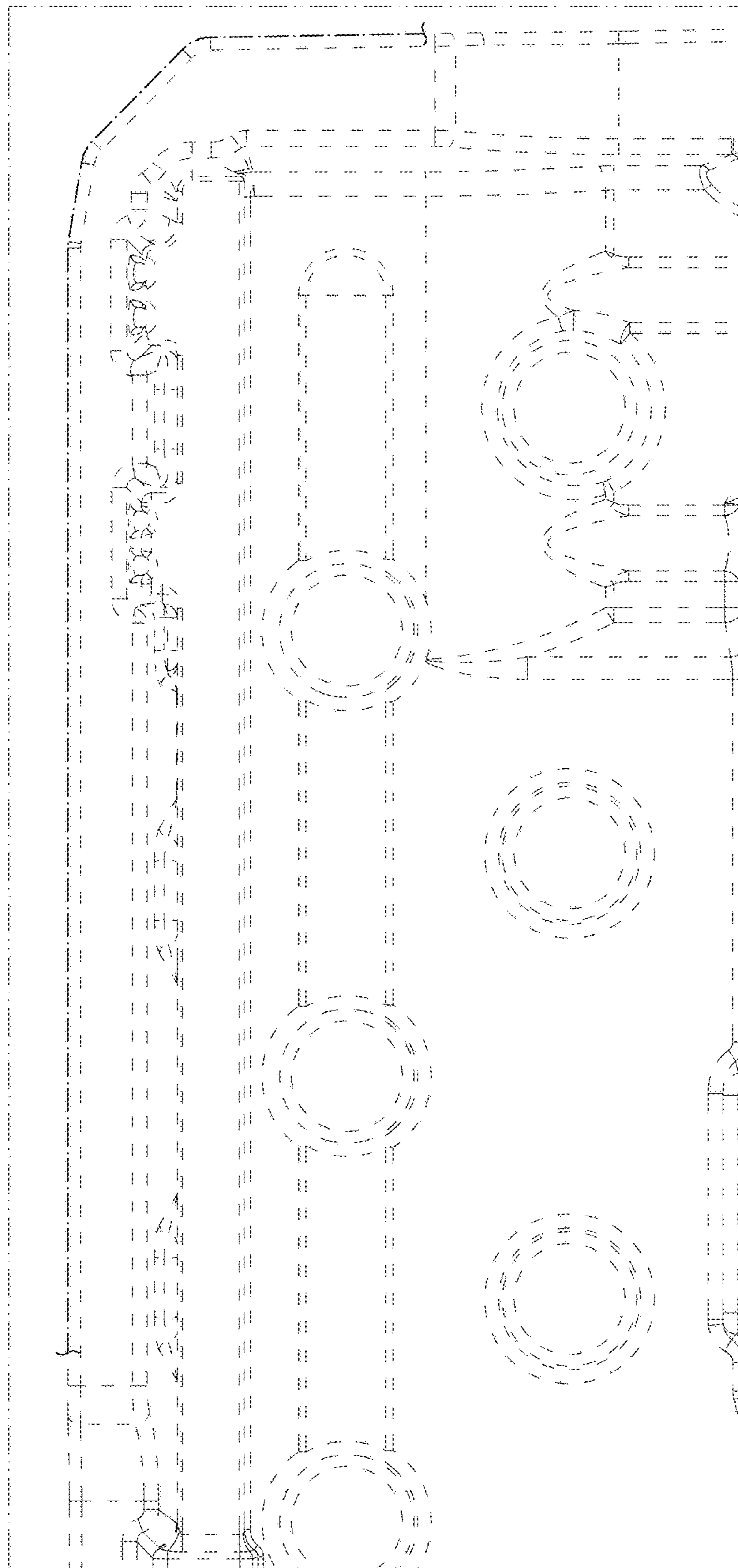

FIG. 18

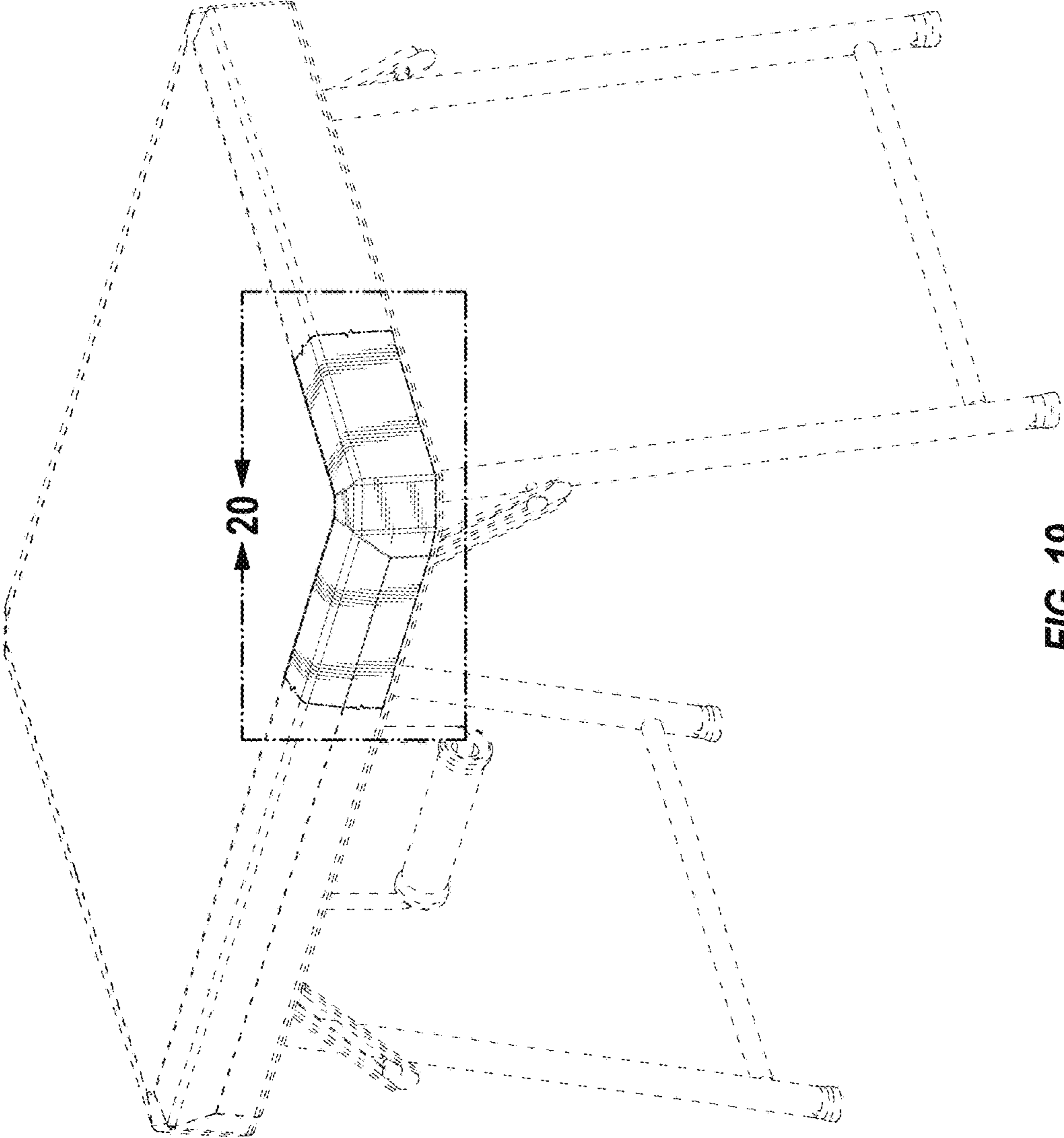

FIG. 19

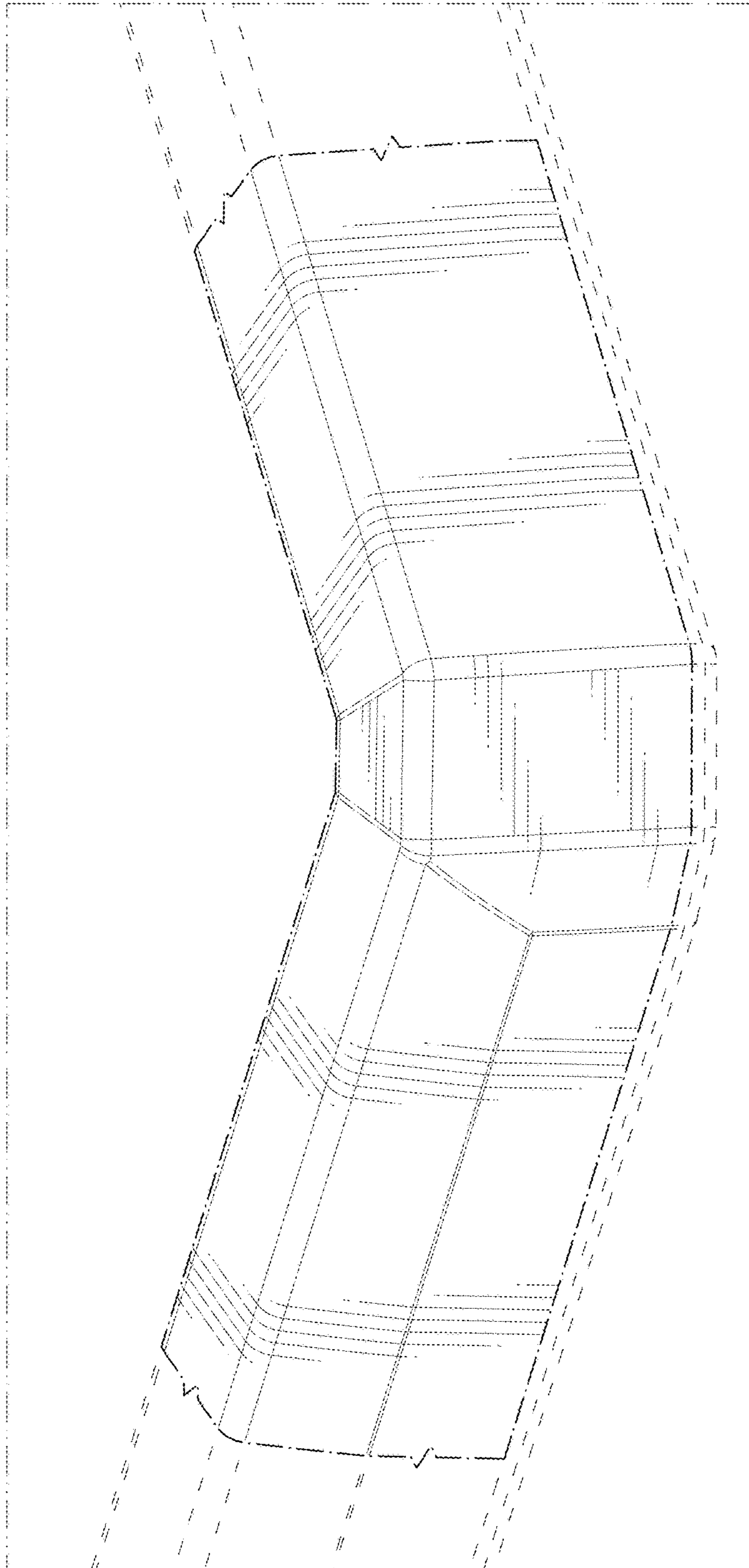

FIG. 20

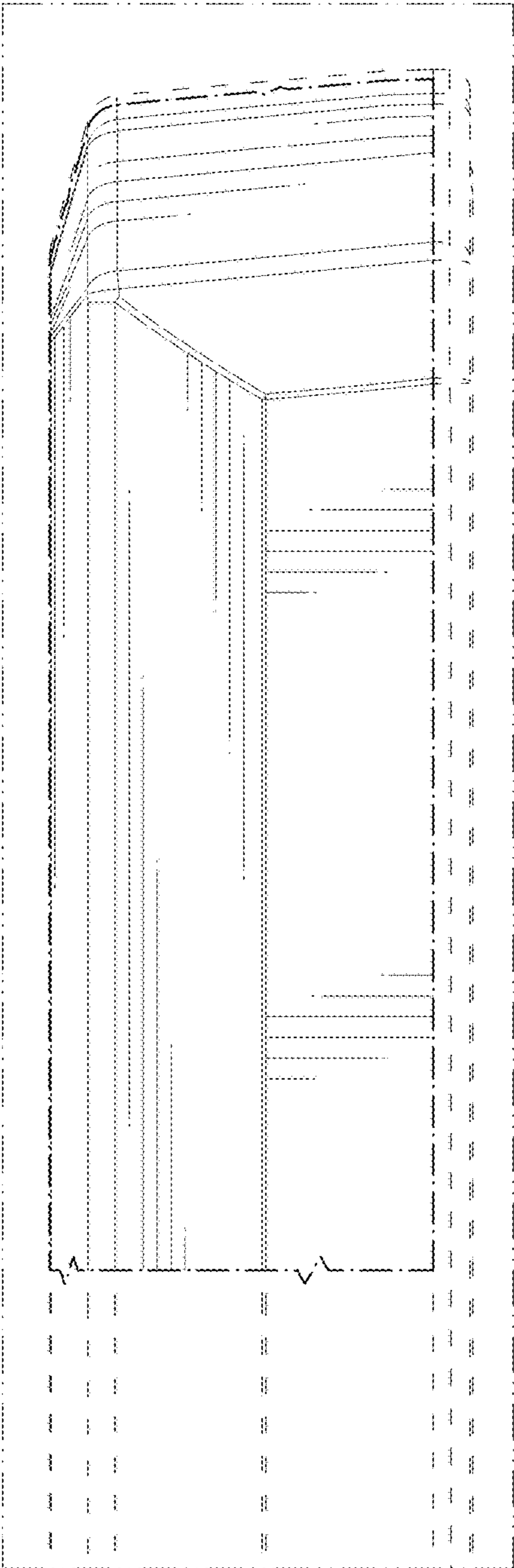

FIG. 21

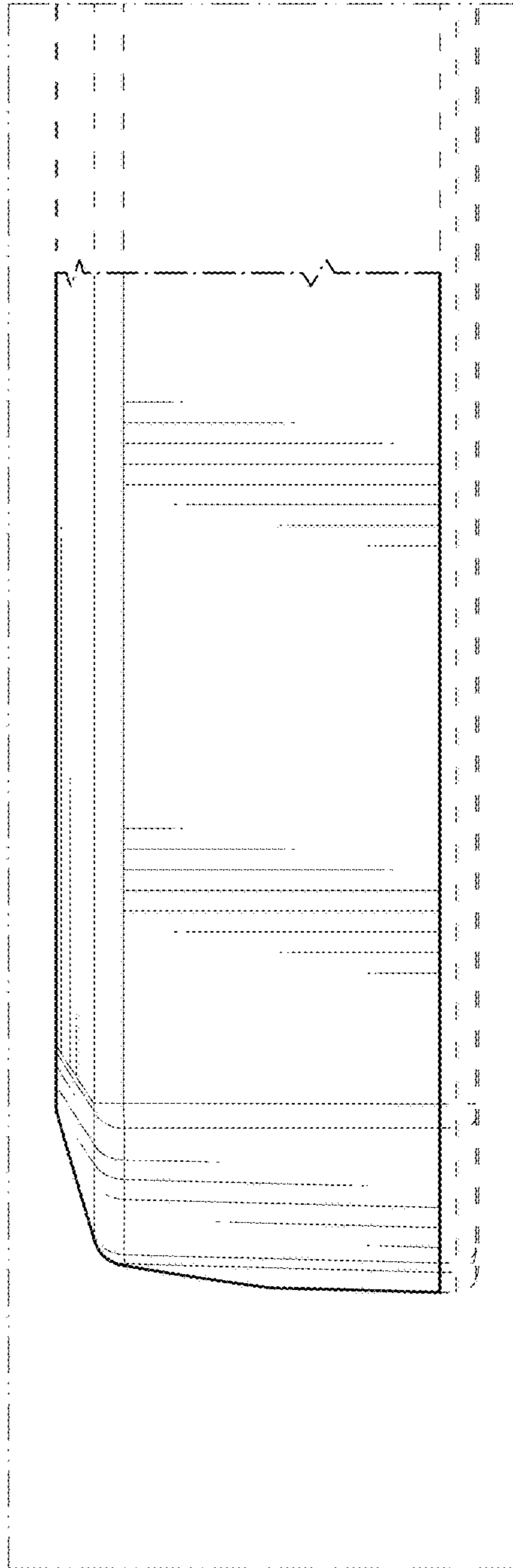

FIG. 22

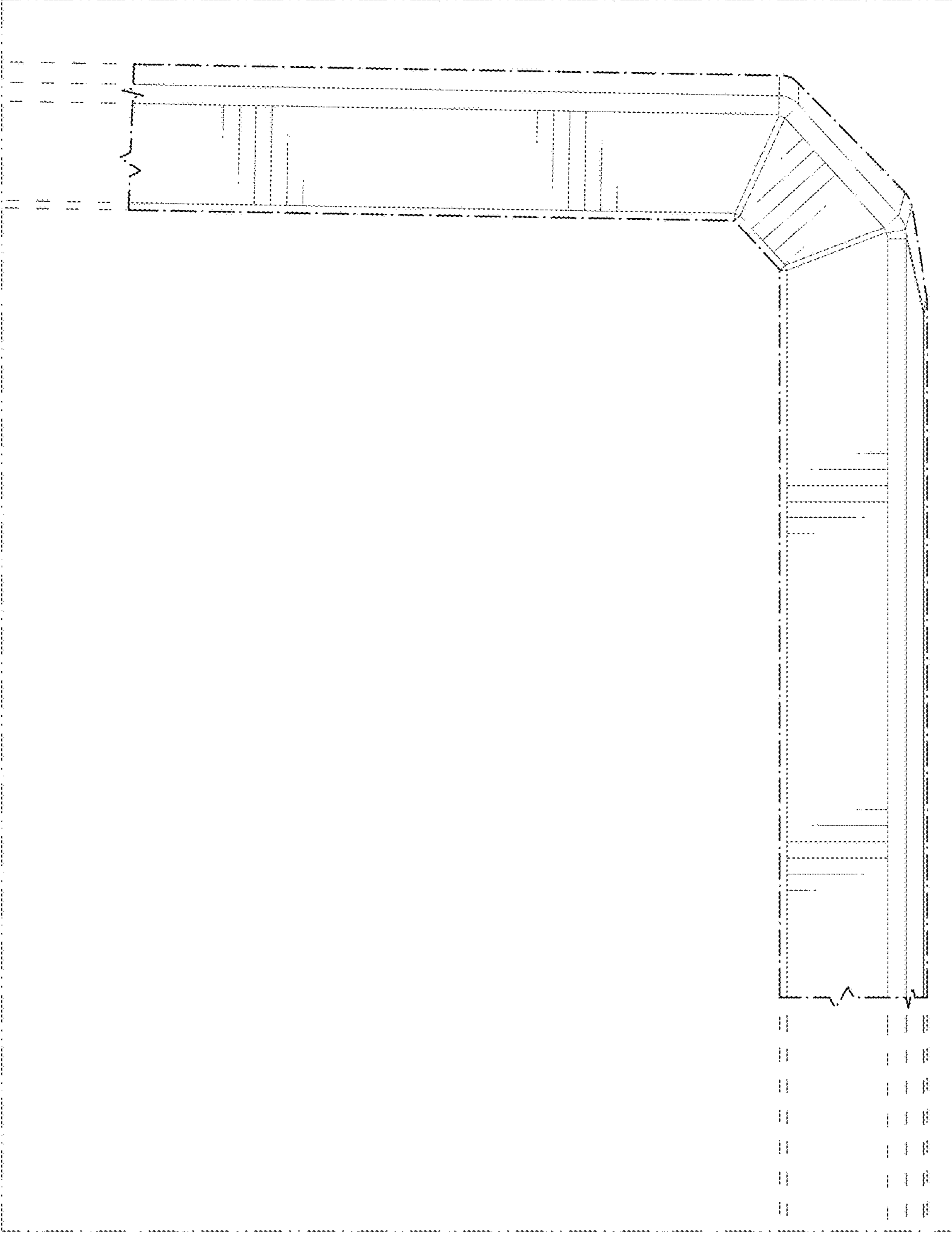

FIG. 23

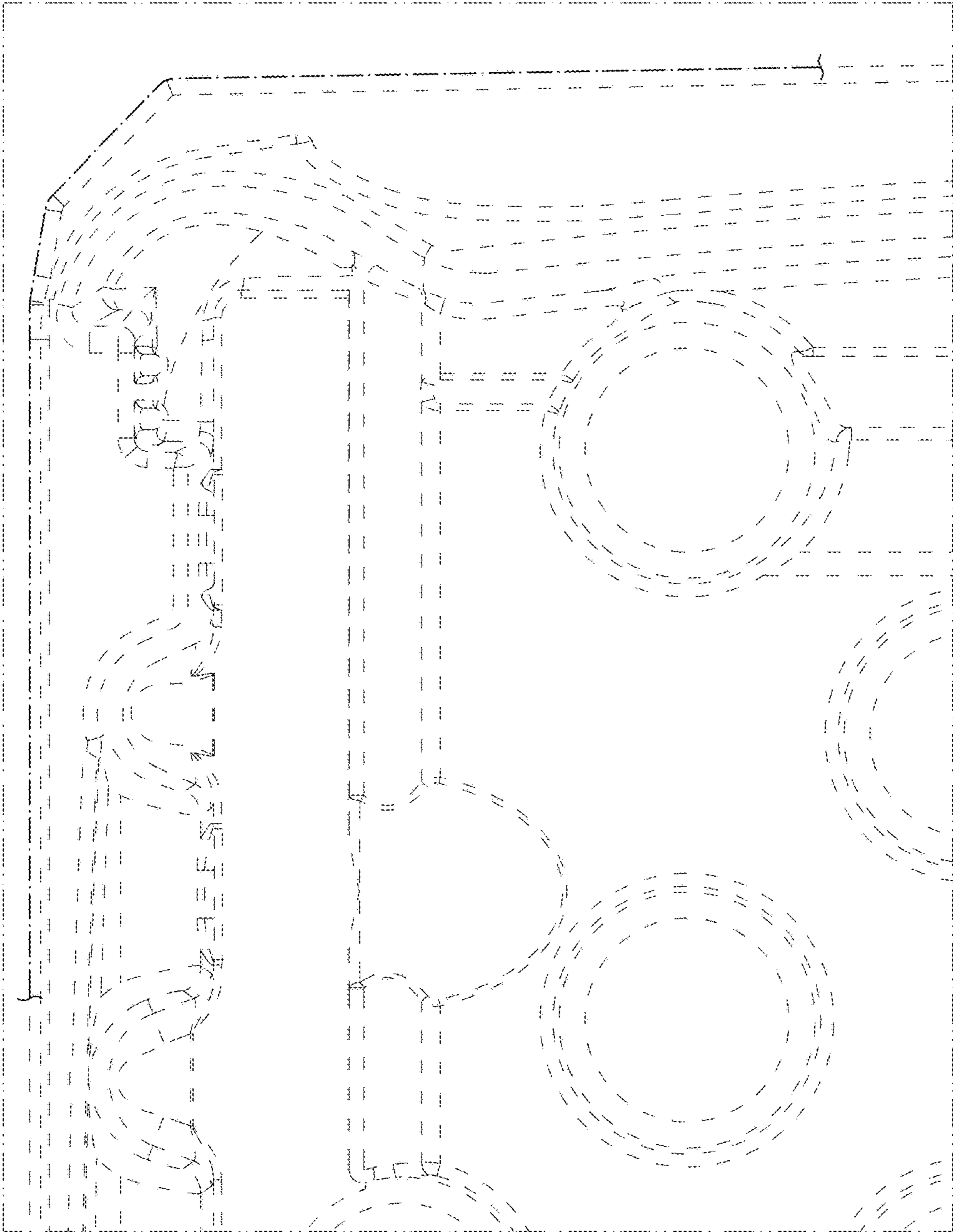

FIG. 24