

US00D867749S

(12) **United States Design Patent** (10) **Patent No.:** **US D867,749 S**
Natsume et al. (45) **Date of Patent:** **** Nov. 26, 2019**

(54) **LANYARD**
(71) Applicant: **MAGIC LEAP, INC.**, Plantation, FL (US)
(72) Inventors: **Shigeru Natsume**, Weston, FL (US); **Bradley Fraser**, Miami Beach, FL (US); **Haney Awad**, Fort Lauderdale, FL (US); **Sebastian Gonzalo Arrieta Gunther**, Fort Lauderdale, FL (US); **Masamune Kaji**, Plantation, FL (US); **William Wheeler**, Fort Lauderdale, FL (US)

D410,330 S * 6/1999 Klein D3/221
6,168,556 B1 * 1/2001 Saavedra A63B 21/4019
224/220
D521,726 S * 5/2006 Tarantino D3/215
D541,190 S * 4/2007 Plzak D11/200
D557,008 S * 12/2007 Stiller D3/207
D621,606 S * 8/2010 Marquardt D3/215
9,016,534 B2 * 4/2015 Whitley A45F 5/00
224/254
D798,042 S * 9/2017 Moreau D3/215
D835,396 S * 12/2018 Raffle D3/215
2014/0001216 A1 * 1/2014 Whitley A45F 5/00
224/258
2016/0050905 A1 * 2/2016 Owen A01M 31/006
224/103

(73) Assignee: **MAGIC LEAP, INC.**, Plantation, FL (US)

(**) Term: **15 Years**

(21) Appl. No.: **29/653,872**

(22) Filed: **Jun. 19, 2018**

(51) **LOC (12) Cl.** **03-01**

(52) **U.S. Cl.** **D3/215**
USPC

(58) **Field of Classification Search**
USPC D3/207, 215, 221, 226, 228; 224/103, 224/219-220, 222, 254, 269, 901.4; D11/7, 200; 294/149
CPC A01K 27/001; A01K 27/003; A44C 19/00; A01M 31/006; A45F 5/00; Y10T 24/3987
See application file for complete search history.

(56) **References Cited**

U.S. PATENT DOCUMENTS

3,294,299 A * 12/1966 Brennan A44C 19/00
224/220
4,982,522 A * 1/1991 Norton F41C 33/00
224/220

OTHER PUBLICATIONS

Everything Branded, 3/4" Polyester Wrist Lanyard (Year: 2019).*

* cited by examiner

Primary Examiner — Catherine R Oliver-Garcia
(74) *Attorney, Agent, or Firm* — Vista IP Law Group, LLP

(57) **CLAIM**

We claim the ornamental design for a lanyard, as shown and described.

DESCRIPTION

FIG. 1 is a perspective view of a lanyard showing our design;
FIG. 2 is a front view thereof;
FIG. 3 is a left view thereof;
FIG. 4 is a rear view thereof;
FIG. 5 is a right view thereof;
FIG. 6 is a top view thereof; and,
FIG. 7 is a bottom view thereof.

1 Claim, 4 Drawing Sheets

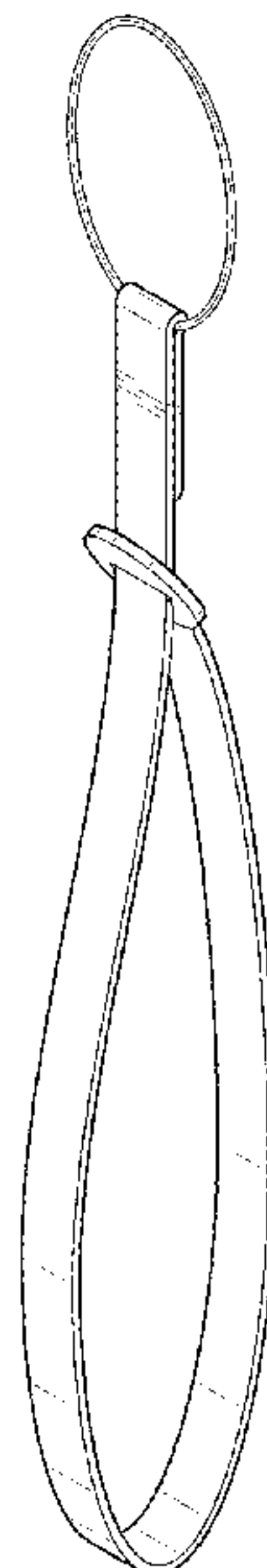

FIG. 1

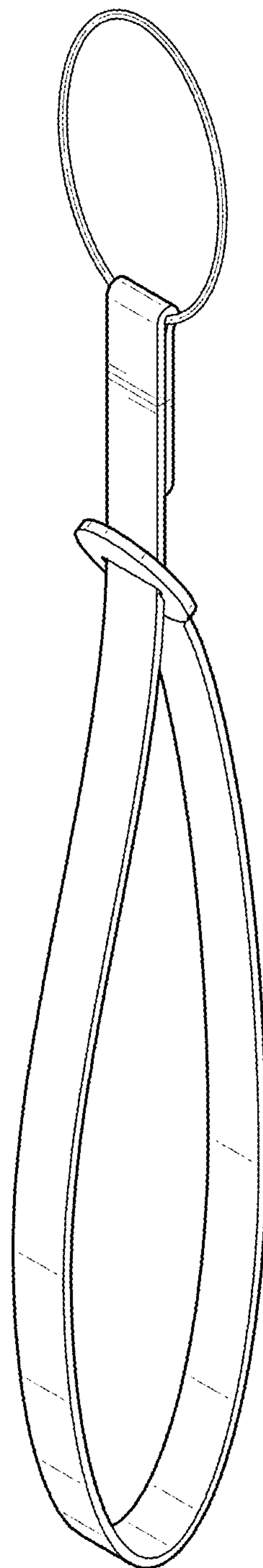

FIG. 2

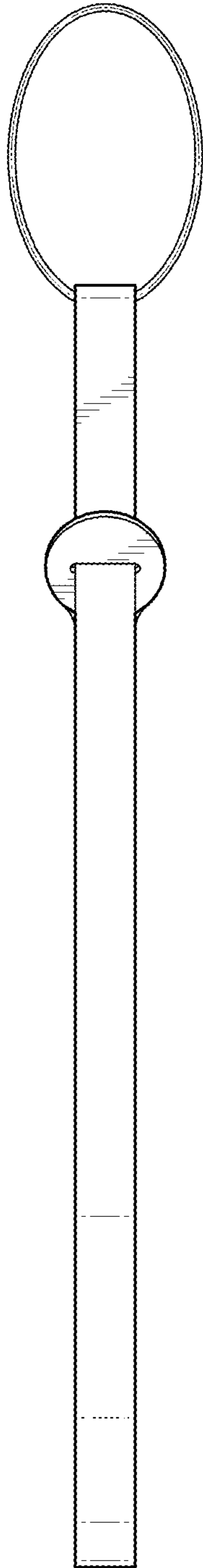

FIG. 3

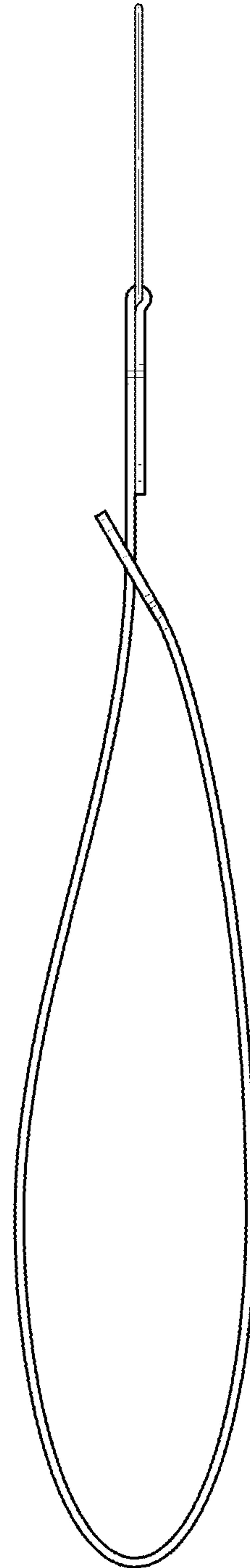

FIG. 4

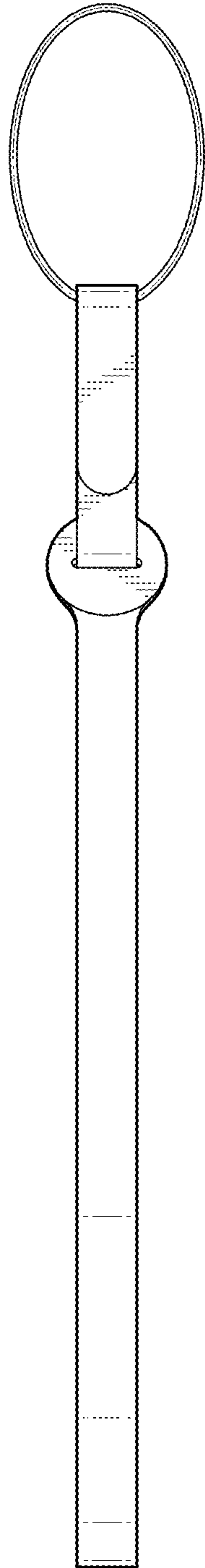

FIG. 5

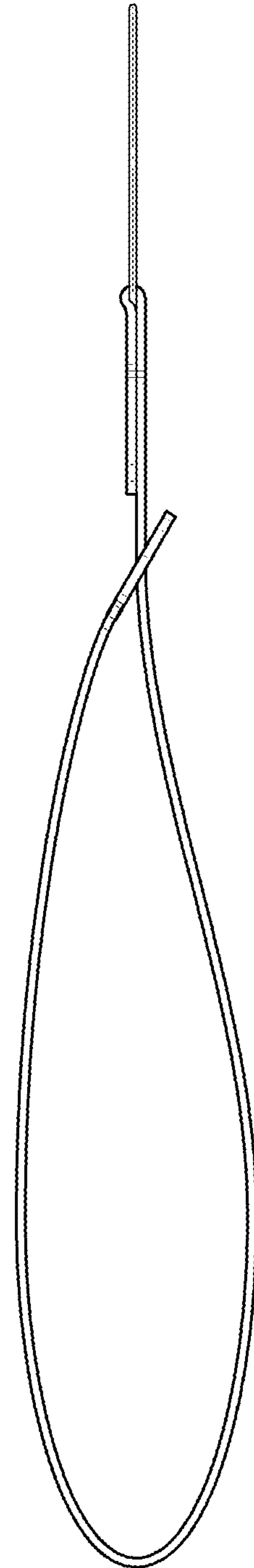

FIG. 6

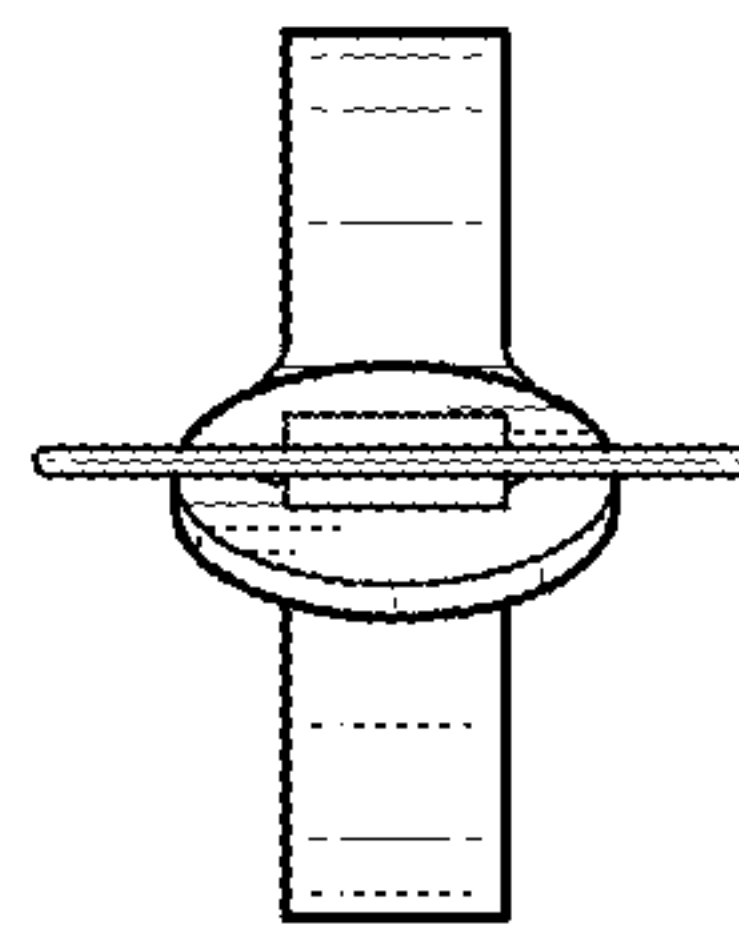

FIG. 7

