



US00D867705S

(12) **United States Design Patent**
Harrington et al.

(10) **Patent No.:** **US D867,705 S**
(45) **Date of Patent:** **** Nov. 19, 2019**

- (54) **BOTTLE**
- (71) Applicant: **Unger Marketing International, LLC**,
Bridgeport, CT (US)
- (72) Inventors: **William Harrington**, Charlestown, RI
(US); **Stephen Huda**, Shelton, CT (US)
- (73) Assignee: **UNGER MARKETING**
INTERNATIONAL, LLC, Bridgeport,
CT (US)

3,457,016 A 7/1969 Gotberg
 4,088,252 A 5/1978 Grunberger
 4,324,012 A 4/1982 Cannaday
 (Continued)

FOREIGN PATENT DOCUMENTS

EP 1761155 3/2007
 WO 9823385 A1 6/1998
 WO 2006002655 1/2006

OTHER PUBLICATIONS

“Excel Screw-in Socket Mop Handle.” clhgroup.co.uk. Date not available. Accessed Jan. 6, 2018. Available online at URL: <https://www.clhgroup.co.uk/products/exel-screw-in-socket-mop-handle/3188>.*

(Continued)

- (**) Term: **15 Years**
- (21) Appl. No.: **29/616,960**
- (22) Filed: **Sep. 11, 2017**
- (51) **LOC (12) Cl.** **07-05**
- (52) **U.S. Cl.**
USPC **D32/45**; D9/550; D9/571; D9/724
- (58) **Field of Classification Search**
USPC D4/116; D6/515–516, 542–545;
D7/300–322, 391–396.2, 509–511, 523,
D7/589, 598, 612, 615, 619.1; D9/435,
D9/436, 439, 440, 443, 447, 454, 500,
D9/503–505, 516–575, 763–783;
D24/197, 133; D28/7, 57, 73, 76–91.1;
215/40–55, 316–354, 370–385;
220/574–575; D32/50–52; D8/81, 83,
D8/107, 303
CPC B65D 1/00; B65D 1/02; B65D 1/0223;
B65D 1/023; B65D 1/0276
See application file for complete search history.

Primary Examiner — Cathron C Brooks
Assistant Examiner — Christian P. McLean
 (74) *Attorney, Agent, or Firm* — Cantor Colburn LLP

(57) **CLAIM**

The ornamental design for a bottle, as shown and described.

DESCRIPTION

FIG. 1 is a top perspective view of a bottle according to the present disclosure;
 FIG. 2 is a bottom perspective view of the bottle of FIG. 1;
 FIG. 3 is a first side view of the bottle of FIG. 1, the opposite side being identical thereto;
 FIG. 4 is a second side view of the bottle of FIG. 1, the opposite side being identical thereto;
 FIG. 5 is a top view of the bottle of FIG. 1; and,
 FIG. 6 is a bottom view of the bottle of FIG. 1.
 The bottle is shown in FIGS. 1-6 with symbolic break lines in the vertical dimension. The appearance of any portion of the article between the break lines forms no part of the claimed design. The remaining broken lines illustrate portions of the bottle that form no part of the claimed design.

1 Claim, 5 Drawing Sheets

- (56) **References Cited**
U.S. PATENT DOCUMENTS
836,115 A 11/1906 Johnson
1,315,194 A 9/1919 Yamamoto
2,187,671 A 1/1940 Suddarth
2,575,124 A 11/1951 Pollitt

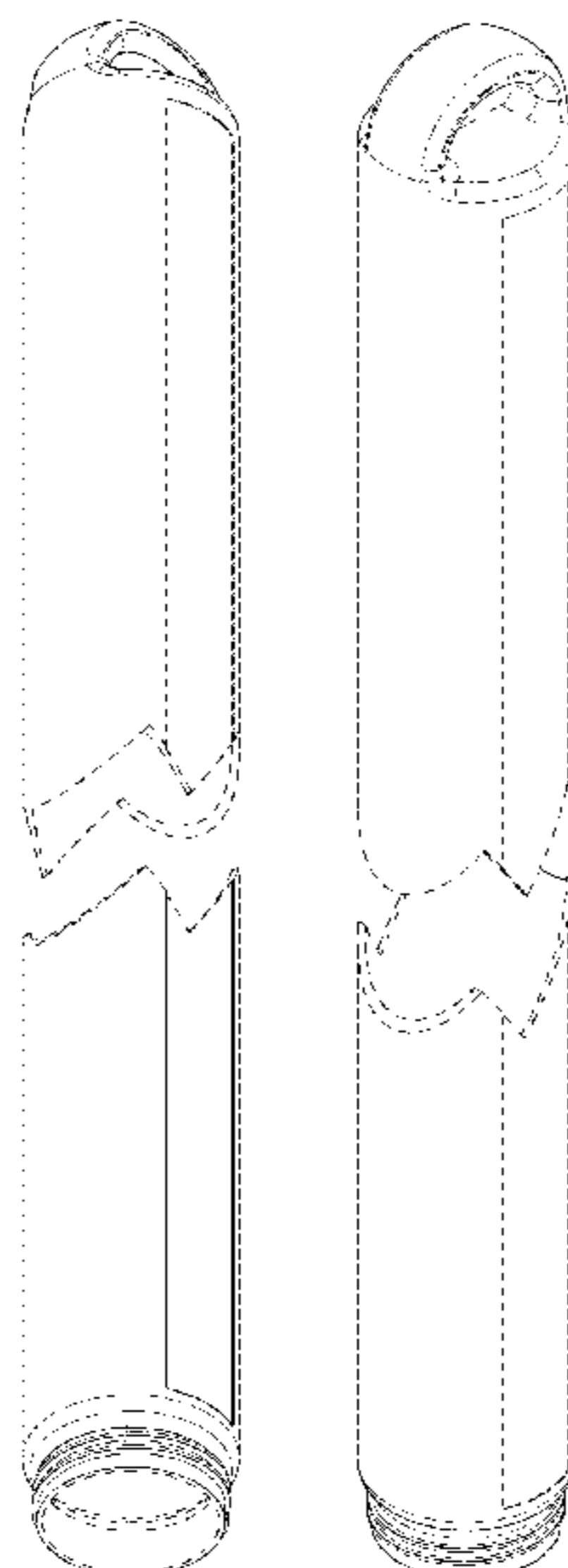

(56)

References Cited

U.S. PATENT DOCUMENTS

D272,582 S *	2/1984	Shepherd	D4/116	D608,885 S	1/2010	Sneddon	
4,704,758 A	11/1987	Hoffman		7,653,958 B2	2/2010	Rosenzweig	
4,809,388 A	3/1989	Dietrich		D611,668 S	3/2010	Wessel	
4,863,299 A	9/1989	Osberghaus		7,670,073 B2	3/2010	Fernschild	
D322,516 S *	12/1991	Korper	D19/66	7,699,551 B2	4/2010	Suda	
D359,605 S	6/1995	Janikowski		7,708,485 B2	5/2010	Tanaka	
D363,374 S *	10/1995	Arntsen	D28/76	7,722,273 B2	5/2010	Tanaka	
5,553,759 A	9/1996	McMaster		7,794,165 B2	9/2010	Balz	
5,632,429 A	5/1997	Cantwell		D629,984 S	12/2010	Carlson	
5,671,872 A	9/1997	Daniels		7,850,384 B2	12/2010	Sacks	
D388,934 S	1/1998	Ames, Jr. et al.		D632,014 S *	2/2011	Lee	D28/76
5,720,071 A	2/1998	Hall		D633,653 S *	3/2011	Lee	D28/76
5,771,535 A	6/1998	Blessing		D639,661 S	6/2011	Llerena	
5,791,006 A	8/1998	Anctil		8,069,520 B2	12/2011	Mattucci	
5,823,414 A	10/1998	Gal		8,079,770 B2	12/2011	Widmer	
5,888,006 A	3/1999	Ping		D654,375 S *	2/2012	Kuboshima	D9/443
D411,673 S	6/1999	Biggs et al.		8,162,194 B2	4/2012	Gleason	
5,920,944 A	7/1999	Biggs		D660,533 S	5/2012	Hill	
5,954,253 A	9/1999	Swetish		8,186,898 B2	5/2012	Bradbury	
6,023,924 A	2/2000	Babineau		D661,442 S	6/2012	Kandasamy	
6,170,112 B1	1/2001	Mayfield		8,205,293 B2	6/2012	Rosenzweig	
D458,721 S	6/2002	Clarke		8,241,427 B1	8/2012	Crawford	
6,397,427 B1	6/2002	Bryngelsson		8,267,607 B2	9/2012	Harris	
6,487,747 B2	12/2002	Cavalheiro		D671,638 S *	11/2012	Young	D24/113
6,497,525 B1	12/2002	Huang		8,375,499 B1	2/2013	Marino	
6,540,424 B1	4/2003	Hall		D680,701 S	4/2013	Carlson	
6,550,998 B1	4/2003	Fernschild		8,425,137 B1	4/2013	Sampaio	
6,551,001 B2	4/2003	Aberegg		8,449,212 B2	5/2013	Crawford	
6,579,023 B2	6/2003	Kunkler		D694,483 S	11/2013	Hines	
6,612,768 B2	9/2003	Zorzo		8,596,896 B2	12/2013	Kimura	
6,651,853 B2	11/2003	Higgins		8,641,309 B2	2/2014	Perry	
6,655,866 B1	12/2003	Morad		8,662,778 B2	3/2014	Crawford	
6,659,670 B1	12/2003	Blouse		8,667,637 B2	3/2014	Vrdoljak	
6,663,306 B2	12/2003	Policicchio		8,672,203 B2	3/2014	Staudecke	
6,669,391 B2	12/2003	Policicchio		8,807,858 B2	8/2014	Fitzpatrick	
6,695,516 B2	2/2004	DeFields		8,834,053 B2	9/2014	Van Landingham, Jr.	
6,722,806 B2	4/2004	Kunkler		8,844,088 B2	9/2014	Garcia Castillo	
6,726,388 B1	4/2004	Monahan		8,894,315 B2	11/2014	Dingert	
D496,398 S *	9/2004	Greenberg	D19/163	8,927,480 B2	1/2015	Williams	
6,799,916 B2	10/2004	Fernschild		8,973,200 B2	3/2015	Mallett	
D499,653 S *	12/2004	Karim	D19/901	9,004,563 B2	4/2015	Buzby	
6,854,911 B2	2/2005	Policicchio		D731,244 S	6/2015	Kohl	
6,854,912 B2	2/2005	Dyer		9,044,132 B2	6/2015	Kaminer	
D505,762 S	5/2005	Lalanne		9,131,824 B2	9/2015	Crawford	
6,889,917 B2	5/2005	Fahy		D741,655 S	10/2015	Whelan	
6,892,915 B2	5/2005	Mares		D742,609 S	11/2015	Irwin	
6,893,180 B2	5/2005	Hall		D747,054 S	1/2016	Seifts	
6,899,485 B2	5/2005	Hall		D757,646 S *	5/2016	Pearson	D13/103
6,951,430 B2	10/2005	Fernschild		D764,129 S	8/2016	Kindler	
6,953,299 B2	10/2005	Wang		9,420,933 B2	8/2016	Kellis	
6,955,490 B2	10/2005	Chase		D770,848 S	11/2016	Wilson	
6,960,042 B1	11/2005	Hsiao		D775,893 S	1/2017	Buckley	
6,964,535 B2	11/2005	Bell		D784,085 S	4/2017	Langston	
D512,567 S	12/2005	Eckhardt		D789,519 S *	6/2017	Ratjen	D24/112
6,981,533 B2	1/2006	Zorzo		D790,279 S	6/2017	Izen	
6,986,618 B2	1/2006	Hall		D790,686 S *	6/2017	Cox	D24/112
6,986,619 B2	1/2006	Hall		9,737,843 B2	8/2017	Chou	
7,004,658 B2	2/2006	Hall		9,743,819 B2	8/2017	Davidshofer	
D518,239 S *	3/2006	Martinez	D28/76	D796,665 S *	9/2017	Tafazoli	D24/112
7,048,458 B2	5/2006	Hall		9,764,101 B2 *	9/2017	McLoughlin	A61M 5/3134
7,048,804 B2	5/2006	Kisela		D811,147 S *	2/2018	DeBaker	D7/300
7,056,050 B2	6/2006	Sacks		D817,961 S *	5/2018	Han	D14/426
7,160,044 B2	1/2007	Dyer		D819,804 S *	6/2018	Knight	D24/113
7,163,349 B2	1/2007	Policicchio		D822,299 S *	7/2018	Fair	D32/50
7,172,099 B2	2/2007	Hofte		D832,521 S *	10/2018	West	D28/76
7,191,486 B1	3/2007	Michelson		D842,701 S *	3/2019	Suga	D9/500
7,341,389 B2	3/2008	Chase		D851,333 S *	6/2019	Nagata	D28/89
7,431,524 B2	10/2008	Sacks		D852,444 S *	6/2019	Harrington	D32/45
D586,514 S	2/2009	Perelli		D853,035 S *	7/2019	Moretti	D28/76
D590,117 S	4/2009	Crawford		2002/0174641 A1	11/2002	Biggs	
D592,819 S	5/2009	Crawford		2003/0000036 A1	1/2003	Fan	
D597,269 S *	7/2009	McNeil	D32/45	2003/0052204 A1	3/2003	Aberegg	
D602,664 S	10/2009	Crawford		2003/0089383 A1	5/2003	Biggs	
7,618,206 B2	11/2009	Sacks		2003/0103795 A1	6/2003	Hollars et al.	
7,621,686 B2	11/2009	Fernschild		2003/0126710 A1	7/2003	Policicchio	
				2003/0150478 A1	8/2003	Biggs	
				2003/0200631 A1	10/2003	Clarke	
				2004/0055099 A1	3/2004	Greenberg	
				2004/0071490 A1	4/2004	Vosbikian	

(56)

References Cited

U.S. PATENT DOCUMENTS

2004/0134016 A1 7/2004 Kisela
 2004/0134955 A1 7/2004 Williams
 2004/0141797 A1 7/2004 Garabedian
 2004/0146333 A1 7/2004 Fu
 2004/0173656 A1 9/2004 Seong
 2004/0223803 A1 11/2004 Fahy
 2005/0050689 A1 3/2005 Biggs
 2005/0058500 A1 3/2005 Hall
 2005/0089360 A1 4/2005 Garabedian, Jr.
 2005/0095053 A1 5/2005 Harris
 2005/0191116 A1 9/2005 Flanery
 2005/0205634 A1 9/2005 Han
 2005/0274766 A1 12/2005 Cheng
 2006/0008317 A1 1/2006 Livingstone
 2006/0039743 A1 2/2006 Mensink
 2006/0110207 A1 5/2006 Augustinus Hofte
 2006/0151558 A1 7/2006 Higgins
 2006/0200924 A1 9/2006 Hampton
 2006/0207042 A1 9/2006 Di Paolo
 2006/0213017 A1 9/2006 Bele
 2006/0222441 A1 10/2006 Tanaka
 2006/0280546 A1 12/2006 Dyer
 2007/0020040 A1 1/2007 Sacks
 2007/0140774 A1 6/2007 Dyer
 2007/0231046 A1 10/2007 Whiffen
 2008/0038045 A1 2/2008 Hofte
 2008/0107471 A1 5/2008 Fitzpatrick
 2010/0116861 A1 5/2010 Burrowes
 2011/0064513 A1 3/2011 Van Landingham

2011/0158740 A1 6/2011 Kandasamy
 2011/0247157 A1 10/2011 Caillou
 2011/0309124 A1 12/2011 Dubois
 2012/0227763 A1 9/2012 Hayes
 2012/0304408 A1 12/2012 Crawford
 2013/0056467 A1 3/2013 Shepard
 2013/0263398 A1 10/2013 Irwin
 2013/0291893 A1 11/2013 Stokes
 2014/0317868 A1 10/2014 Fitzpatrick
 2015/0082570 A1 3/2015 Davidshofer
 2015/0101140 A1 4/2015 Pierce
 2016/0001442 A1 1/2016 Buzby
 2016/0345793 A1 12/2016 Hansen
 2017/0028841 A1 2/2017 Sasaki
 2017/0157762 A1 6/2017 Monahan
 2017/0296024 A1 10/2017 Zhu

OTHER PUBLICATIONS

“Mop Handle Screw Fitting.” janitorialdirect.co.uk. Date not available. Accessed Jan. 6, 2018. Available online at URL: <<https://www.janitorialdirect.co.uk/mop-handle-screw-fitting.html>>.*
 AmazonSmile: Spray Mops for Floor Cleaning—New Leader, website 2017, [https://smile.amazon.com/Cleaning_New_Leader-Professional-Degree-Hardwood/dp/B077N . . .](https://smile.amazon.com/Cleaning_New_Leader-Professional-Degree-Hardwood/dp/B077N...) site visited Jan. 15, 2018.
 Unger erGO! clean, website 2016, <https://www.ungerglobal.com/en/ergoclean>, site visited Jan. 6, 2018, 6 pages.
 Unger mop video, video date Sep. 19, 2017, site visited Jan. 17, 2018, <https://www.youtube.com/watch?v=G42VJEfjTrs>.

* cited by examiner

FIG. 1

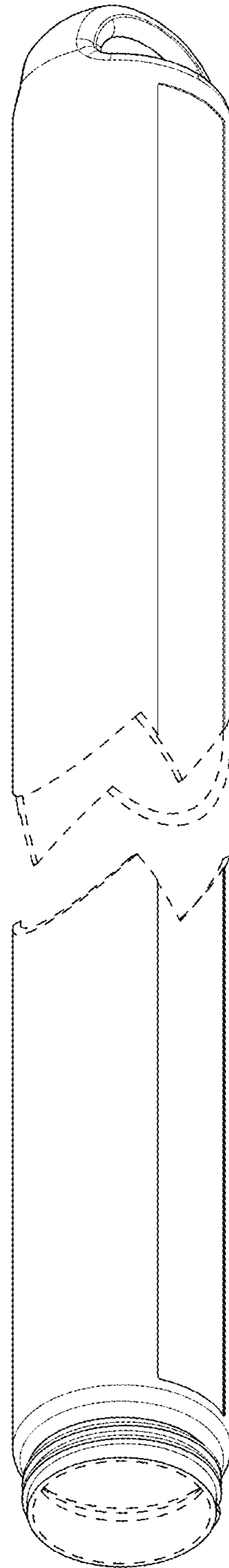

FIG. 2

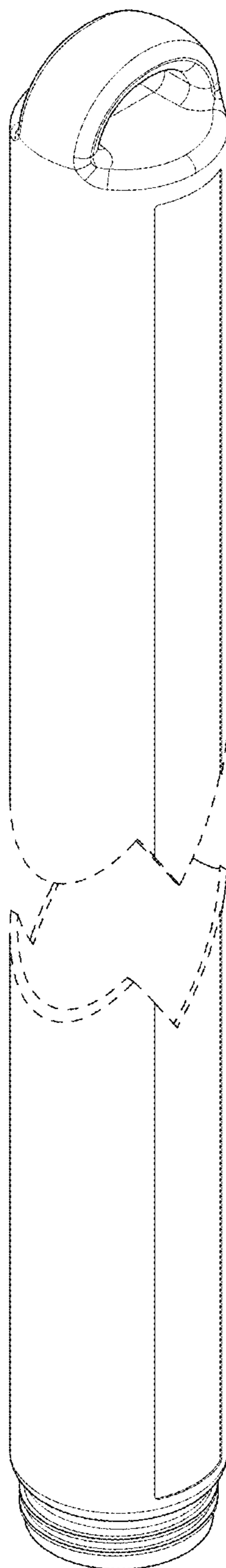

FIG. 3

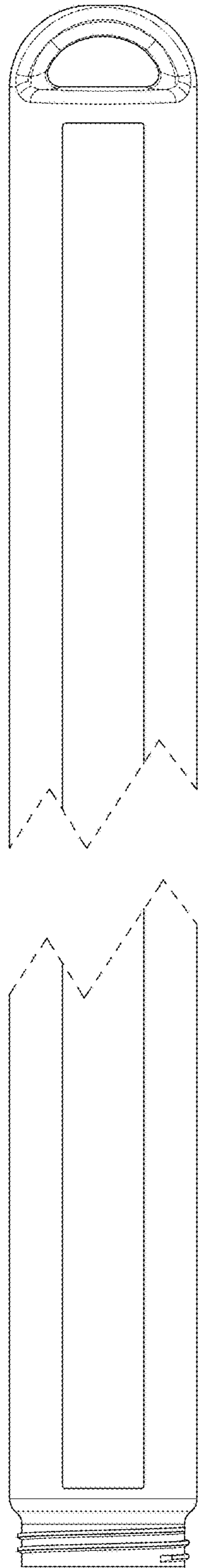
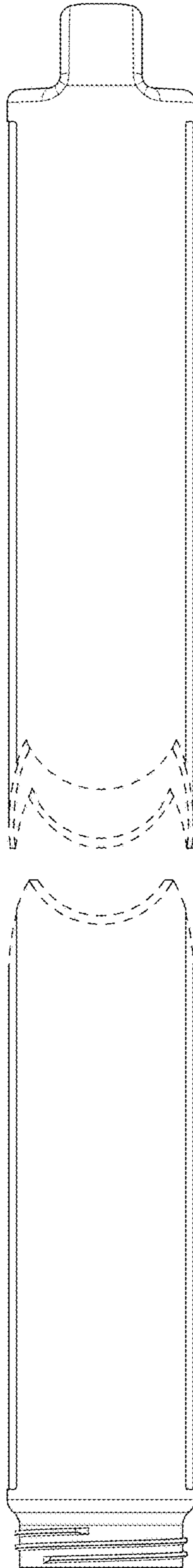

FIG. 4



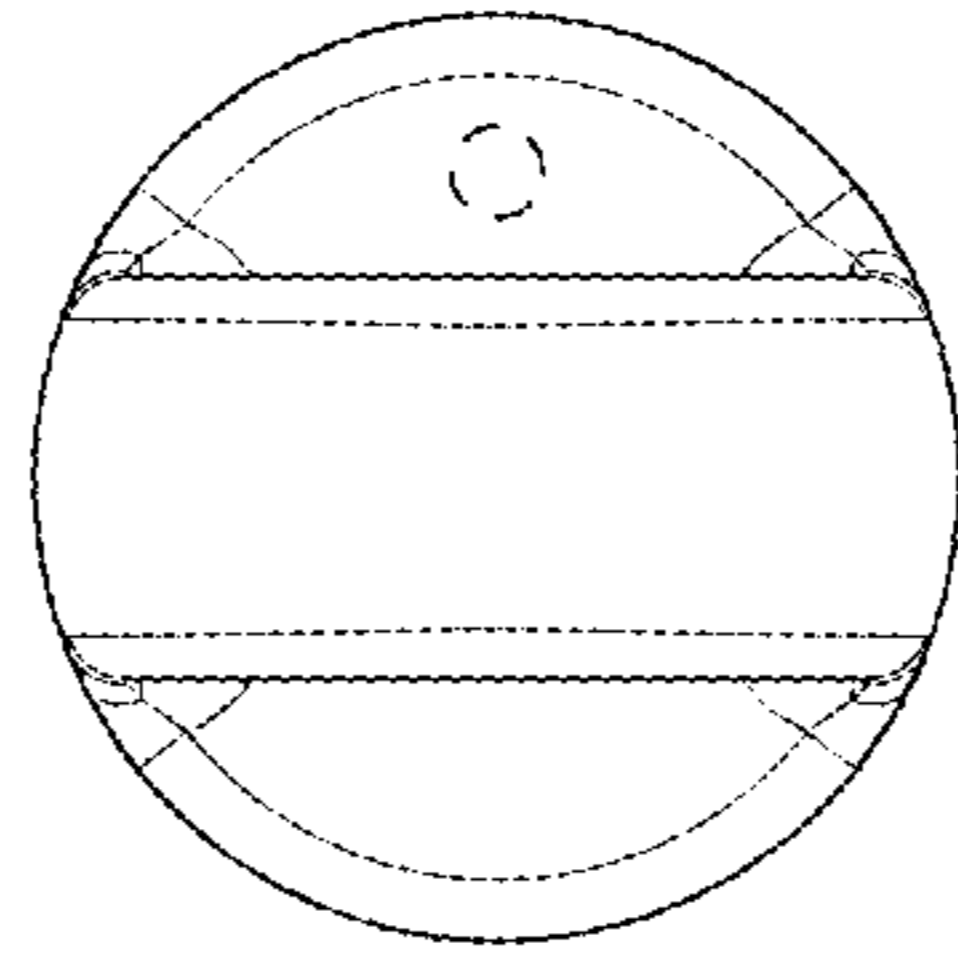

FIG. 5

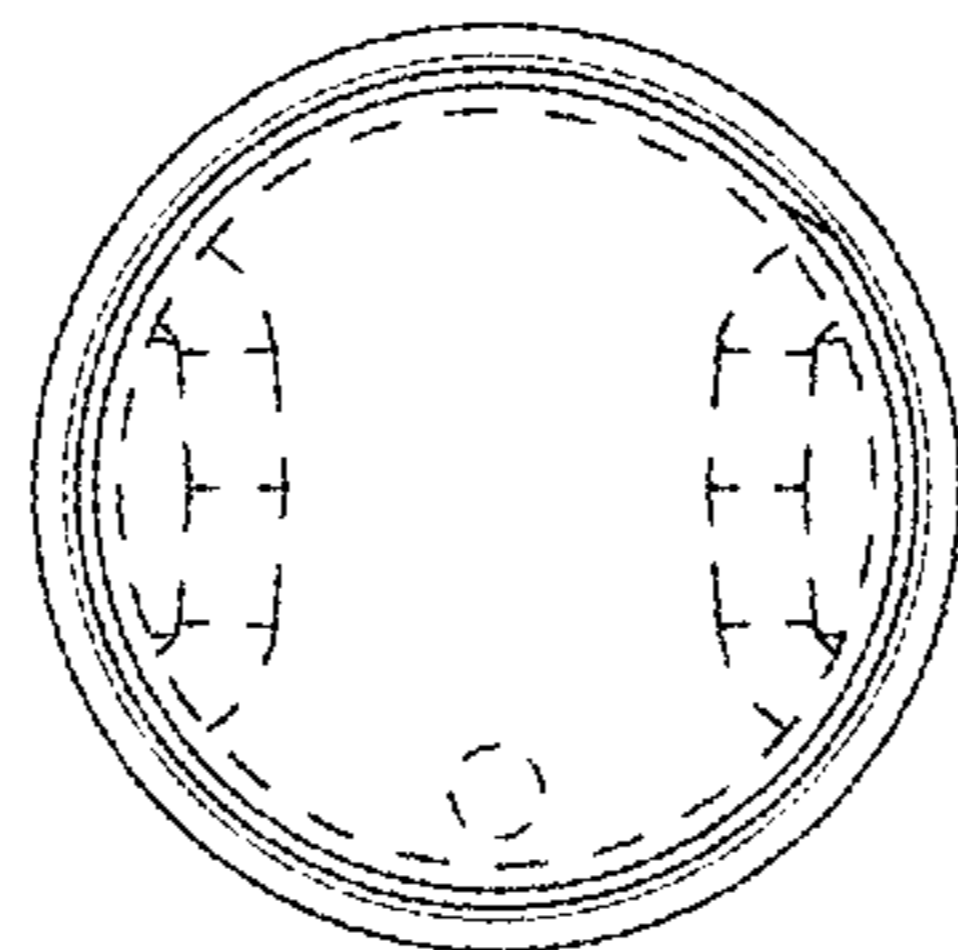

FIG. 6