



US00D867661S

(12) **United States Design Patent** (10) **Patent No.:** **US D867,661 S**  
**Ovvdias** (45) **Date of Patent:** **\*\* Nov. 19, 2019**

(54) **SHAVER CARTRIDGE WITH LUBRICATING STRIP**

(71) Applicant: **Societe BIC**, Clichy (FR)

(72) Inventor: **Nikos Ovvdias**, Paleo Faliro (GR)

(73) Assignee: **Societe BIC**, Clichy (FR)

(\*\*) Term: **15 Years**

(21) Appl. No.: **29/643,744**

(22) Filed: **Apr. 11, 2018**

(51) **LOC (12) Cl.** ..... **28-03**

(52) **U.S. Cl.**  
USPC ..... **D28/47**

(58) **Field of Classification Search**  
USPC ..... D28/45-48  
CPC ..... B26B 21/00-06; B26B 21/08-227; B26B 21/24-28; B26B 21/30-38; B26B 21/40-4093; B26B 21/52-528

See application file for complete search history.

(56) **References Cited**

**U.S. PATENT DOCUMENTS**

D403,811 S *	1/1999	Brown	.....	D28/47
D524,986 S *	7/2006	Prudden, Jr.	.....	D28/47
D542,972 S *	5/2007	Pryor	.....	D28/47
D547,494 S *	7/2007	Watson	.....	D28/47

(Continued)

**OTHER PUBLICATIONS**

Photograph of BIC Hybrid Flex 3.

*Primary Examiner* — Jennifer Rivard

(74) *Attorney, Agent, or Firm* — The H.T. Than Law Group

(57) **CLAIM**

I claim the ornamental design for a shaver cartridge with lubricating strip, as shown and described.

**DESCRIPTION**

FIG. 1 is a front perspective view of a first embodiment of an ornamental design for a shaver cartridge with lubricating strip according to the present invention;  
 FIG. 2 is a front view thereof;  
 FIG. 3 is a back view thereof;  
 FIG. 4 is a left view thereof;  
 FIG. 5 is a right side view thereof;  
 FIG. 6 is a top view thereof;  
 FIG. 7 is a bottom view thereof;  
 FIG. 8 is a front perspective view of a second embodiment of the ornamental design for a shaver cartridge with lubricating strip according to the present invention;  
 FIG. 9 is a front view thereof;  
 FIG. 10 is a back view thereof;  
 FIG. 11 is a left view thereof;  
 FIG. 12 is a right side view thereof;  
 FIG. 13 is a top view thereof;  
 FIG. 14 is a bottom view thereof;  
 FIG. 15 is a front perspective view of a third embodiment of the ornamental design for a shaver cartridge with lubricating strip according to the present invention;  
 FIG. 16 is a front view thereof; the back, left, right, top and bottom views are similar to those in the first and second embodiments;  
 FIG. 17 is a front perspective view of a fourth embodiment of the ornamental design for a shaver cartridge with lubricating strip according to the present invention; and,  
 FIG. 18 is a front view thereof; the back, left, right, top and bottom views are similar to those in the first and second embodiments.

The broken lines illustrate portions of the shaving cartridge with lubricating strip and form no part of the claimed design. All shaded surfaces form part of the claimed design. The photographic images are shown in gray tone; gray tone forms no part of the claimed design.

**1 Claim, 10 Drawing Sheets**

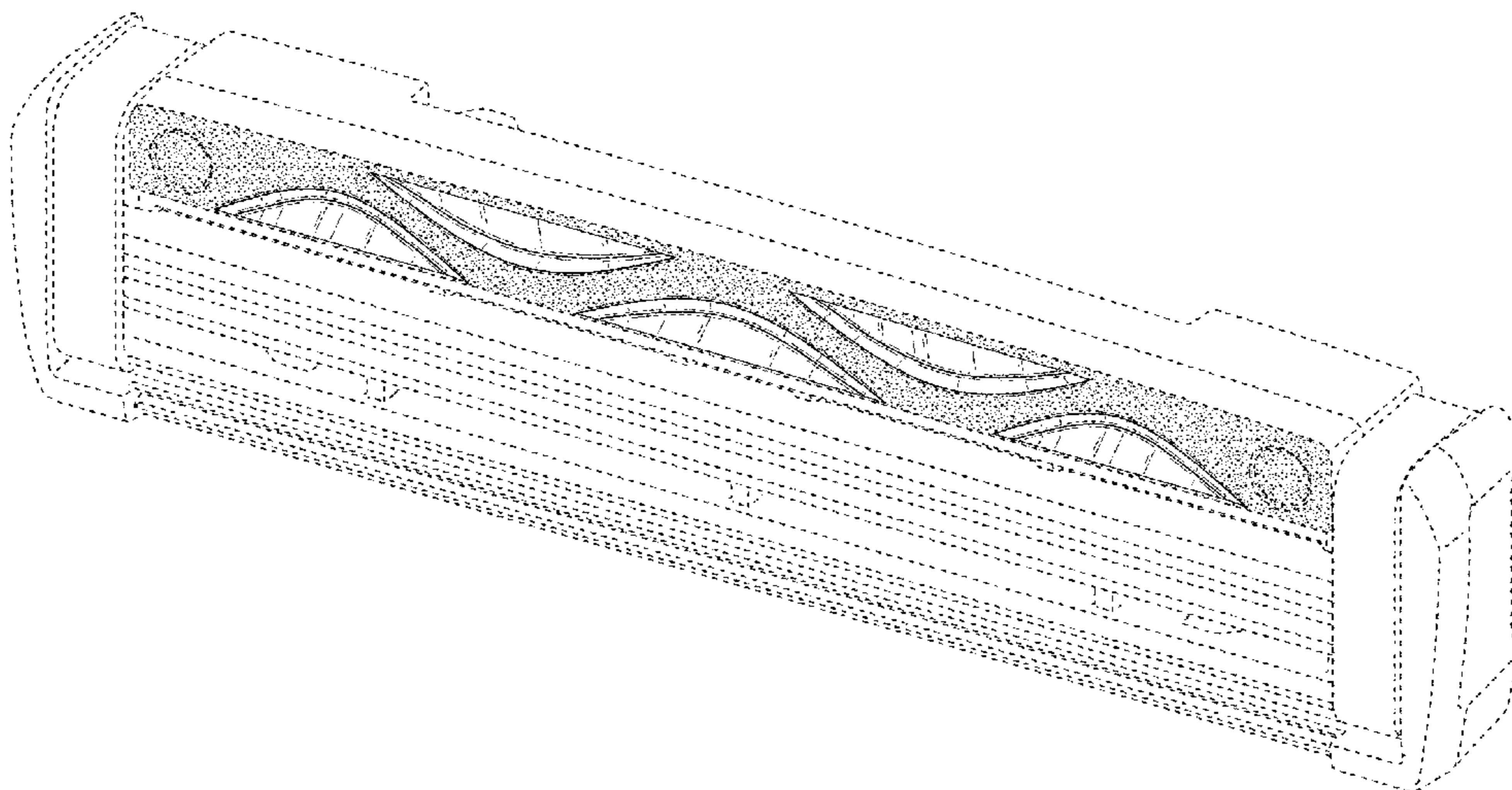

(56)

**References Cited**

U.S. PATENT DOCUMENTS

D556,378	S	*	11/2007	Watson	.....	D28/47
D604,904	S	*	11/2009	Watson	.....	D28/47
D608,501	S	*	1/2010	Wain	.....	D28/47
D617,948	S	*	6/2010	Lukan	.....	D28/47
D617,949	S	*	6/2010	Lukan	.....	D28/47
D622,904	S		8/2010	Kinard et al.		
D627,100	S	*	11/2010	Kinard	.....	D28/47
D627,101	S	*	11/2010	Kinard	.....	D28/47
D627,518	S	*	11/2010	Kinard	.....	D28/47
D630,378	S	*	1/2011	Jung	.....	D28/47
D662,661	S	*	6/2012	Corbeil	.....	D28/47
D665,130	S	*	8/2012	Wain	.....	D28/47
D699,892	S	*	2/2014	Wonderley	.....	D28/47
D741,010	S	*	10/2015	Wang	.....	D28/47
D778,498	S	*	2/2017	Petratou	.....	D28/47
D819,273	S	*	5/2018	Cabrera	.....	D28/47
D823,541	S	*	7/2018	Wertz	.....	D28/46
D844,898	S	*	4/2019	Knapp	.....	D28/47
2011/0126413	A1	*	6/2011	Szczepanowski	.. B26B 21/4087	
						30/41

\* cited by examiner

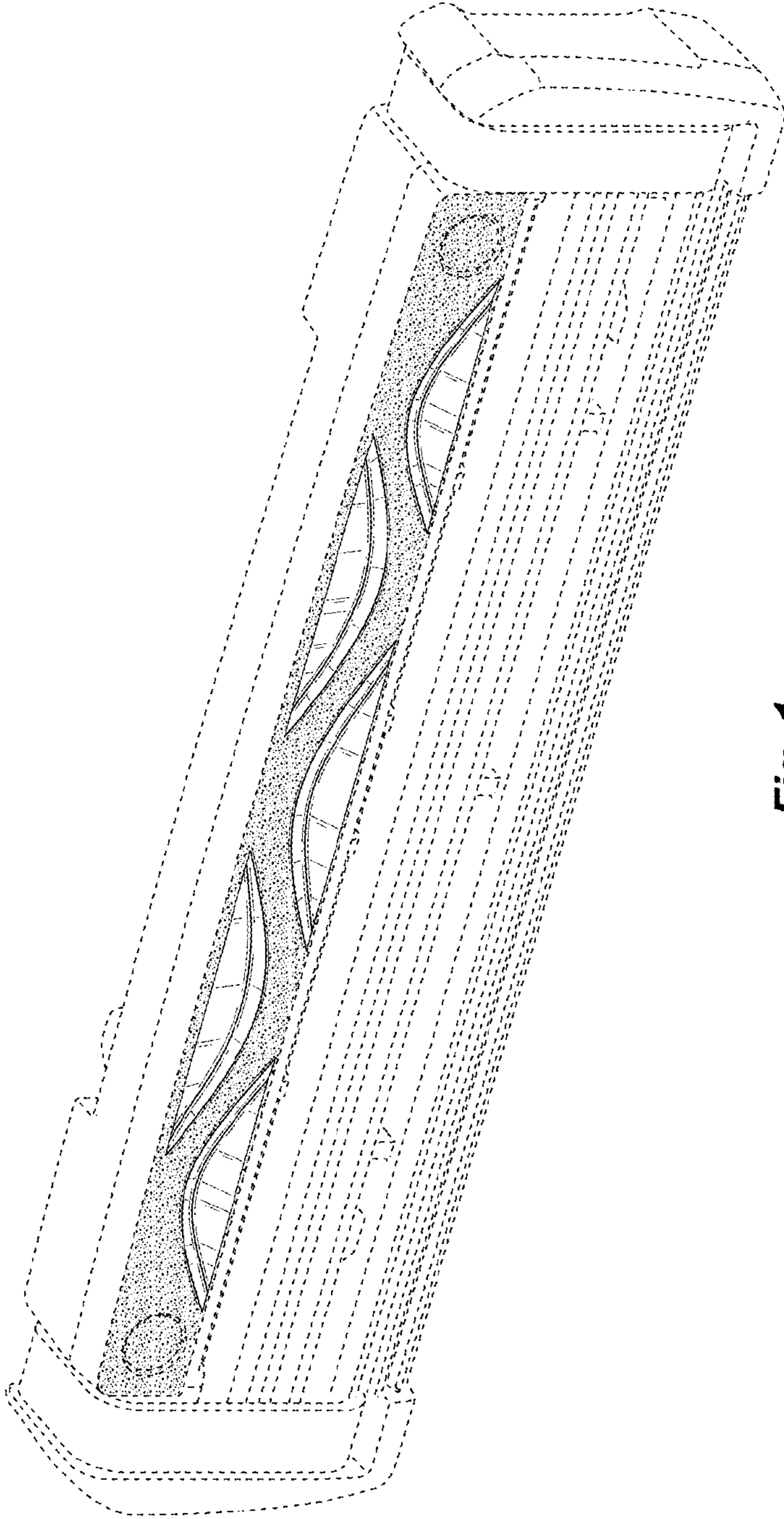

Fig. 1

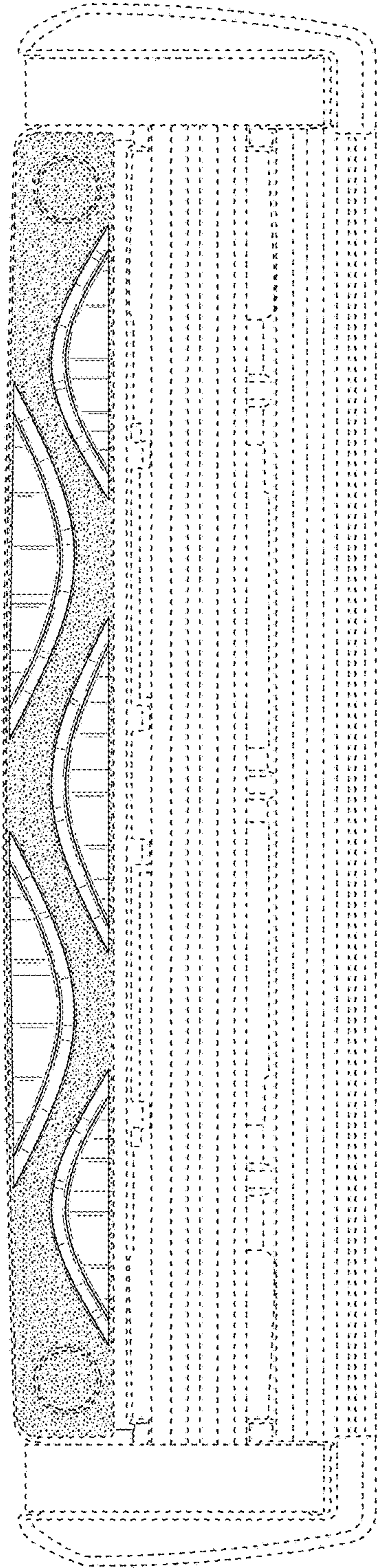

Fig. 2

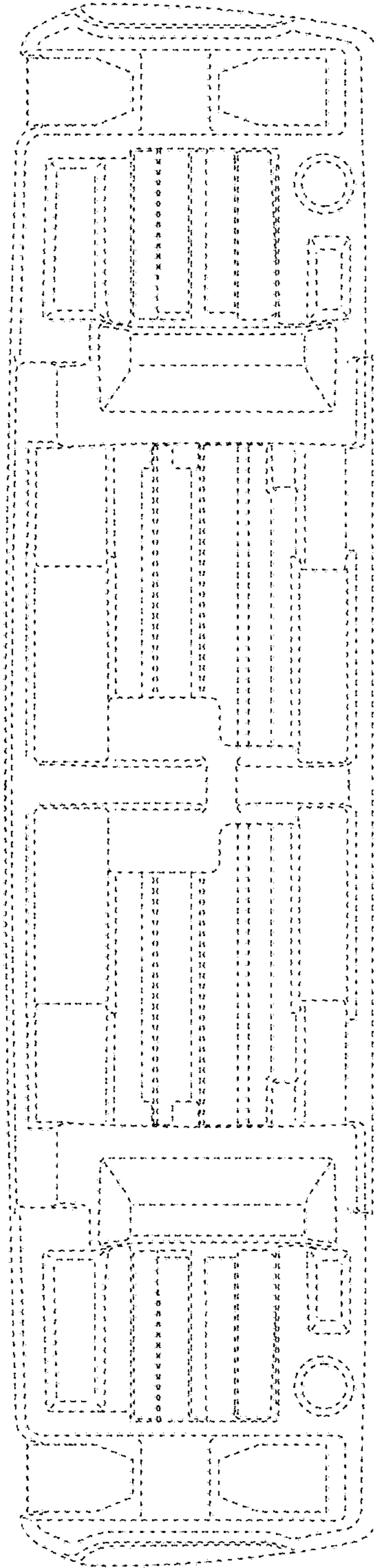
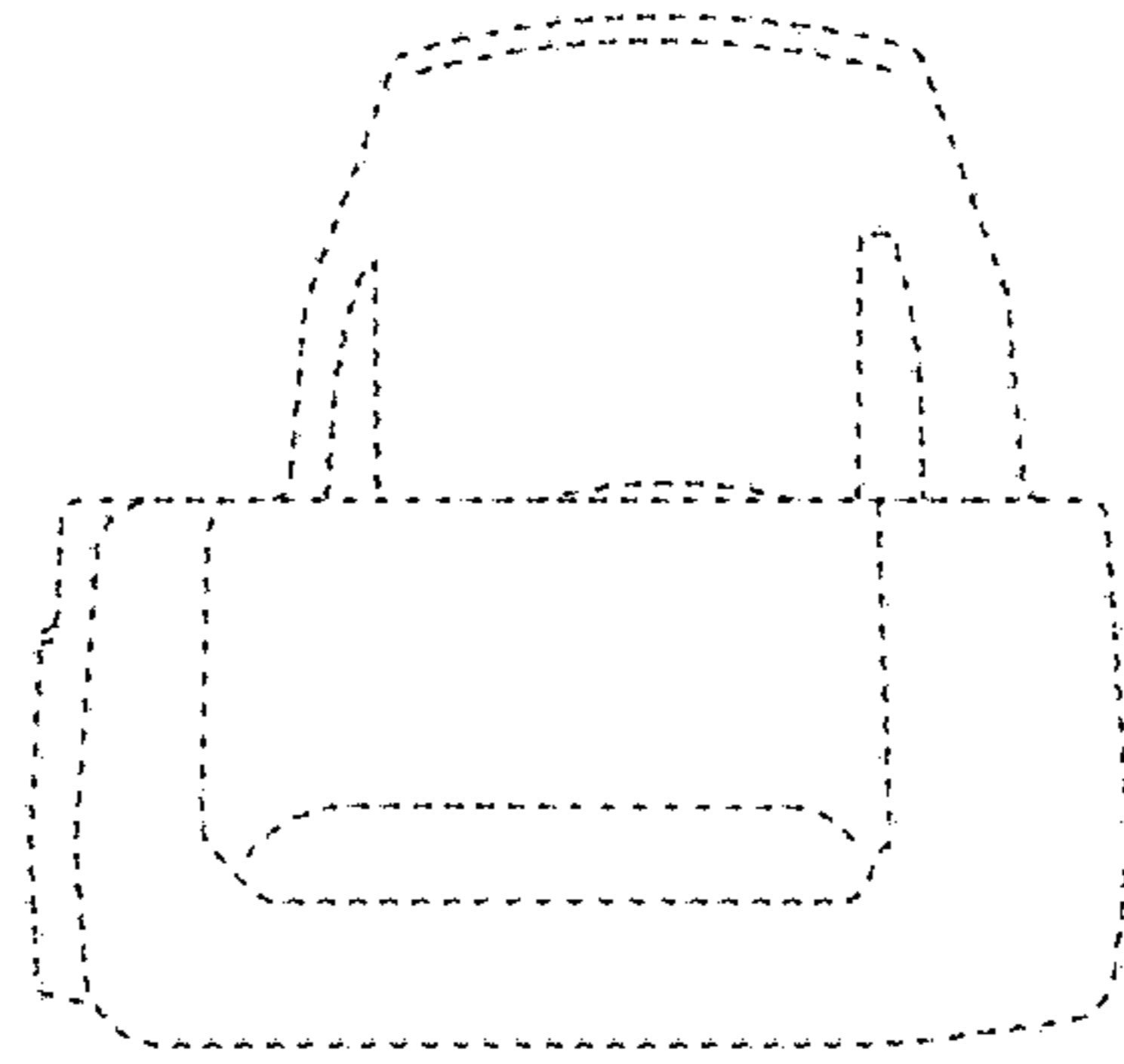
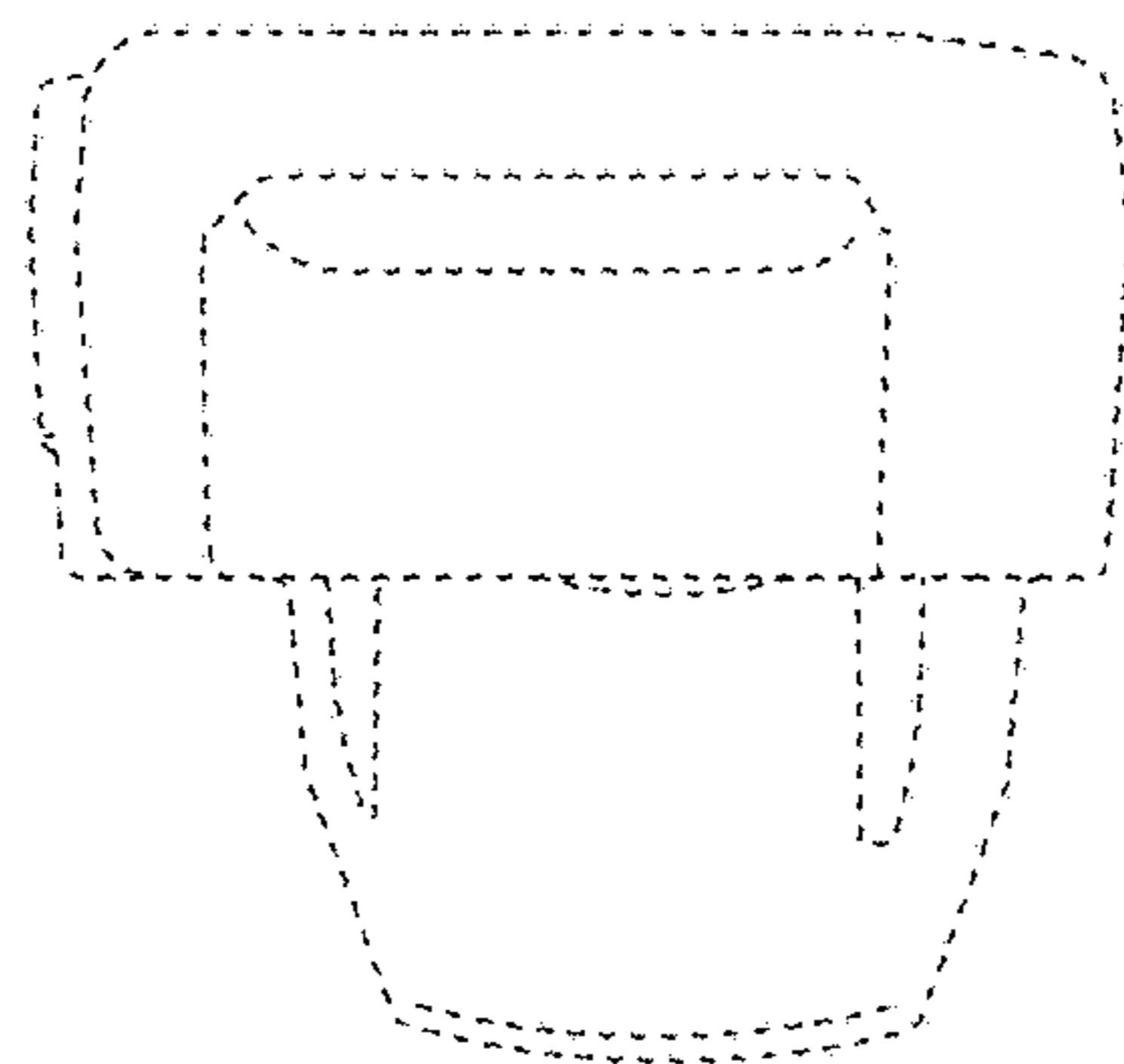

Fig. 3



*Fig. 5*



*Fig. 4*

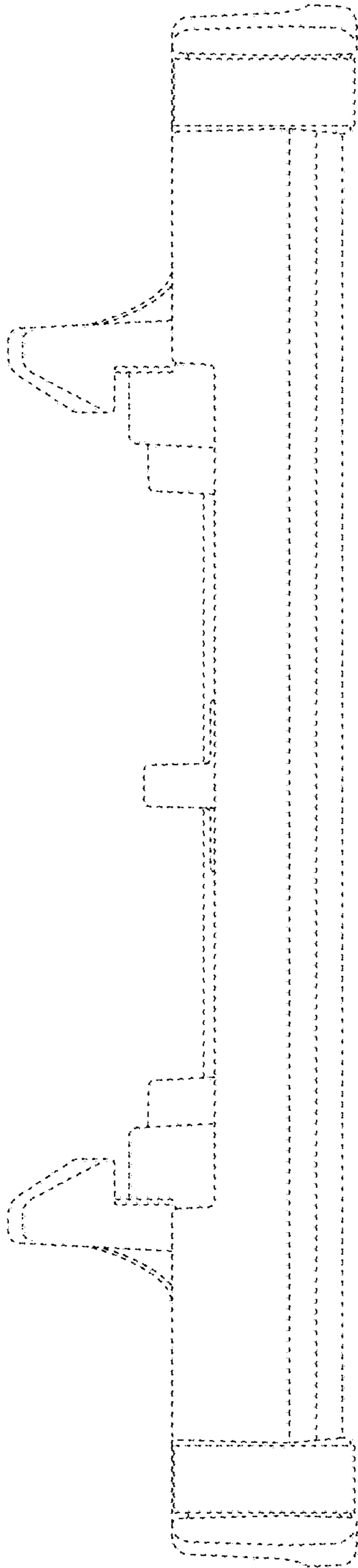

Fig. 6

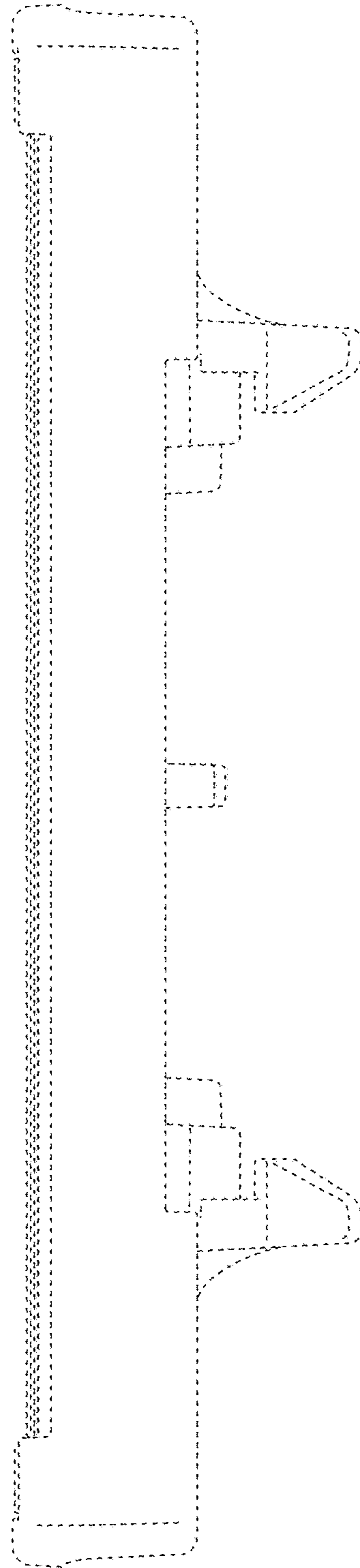

Fig. 7

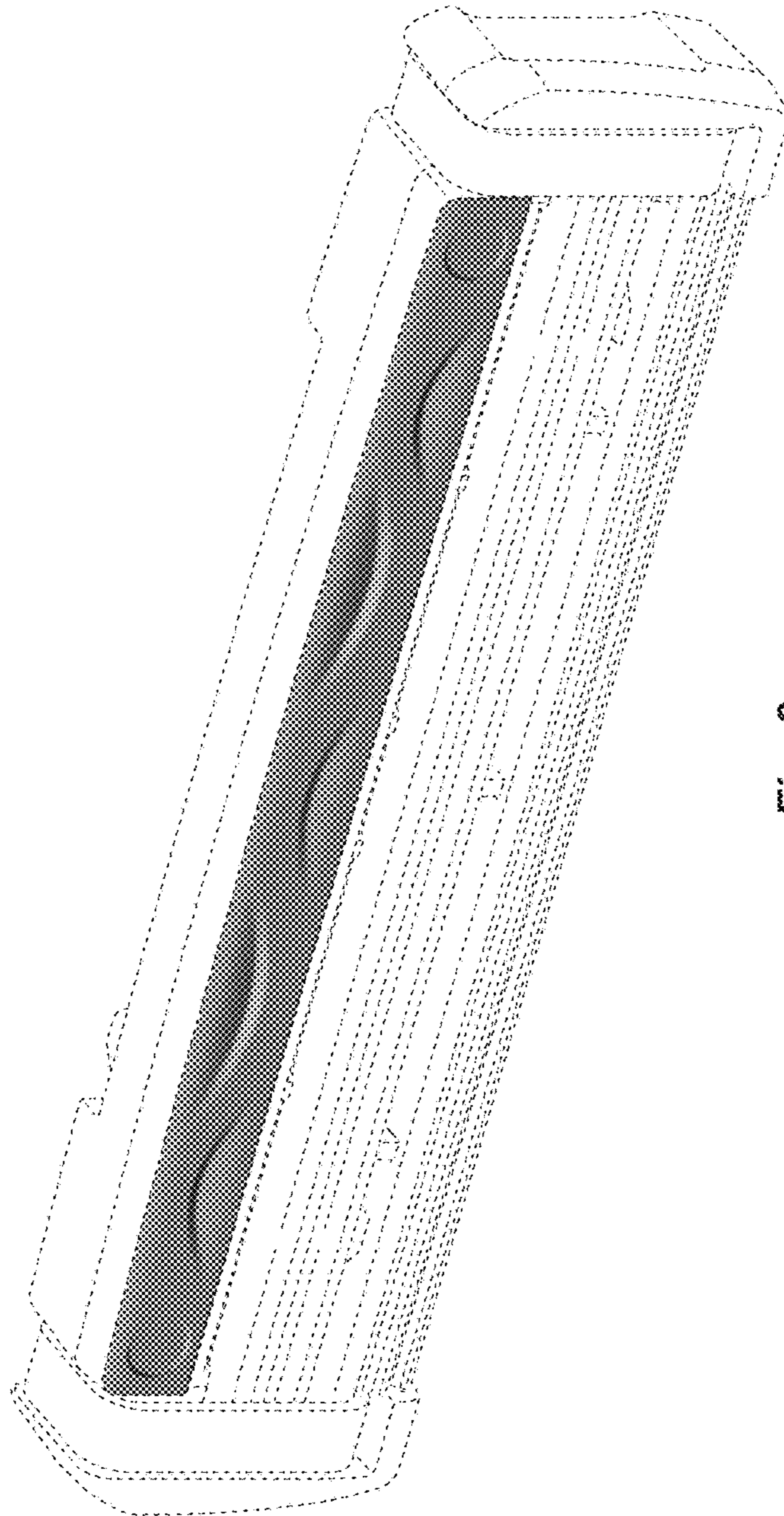

Fig. 8

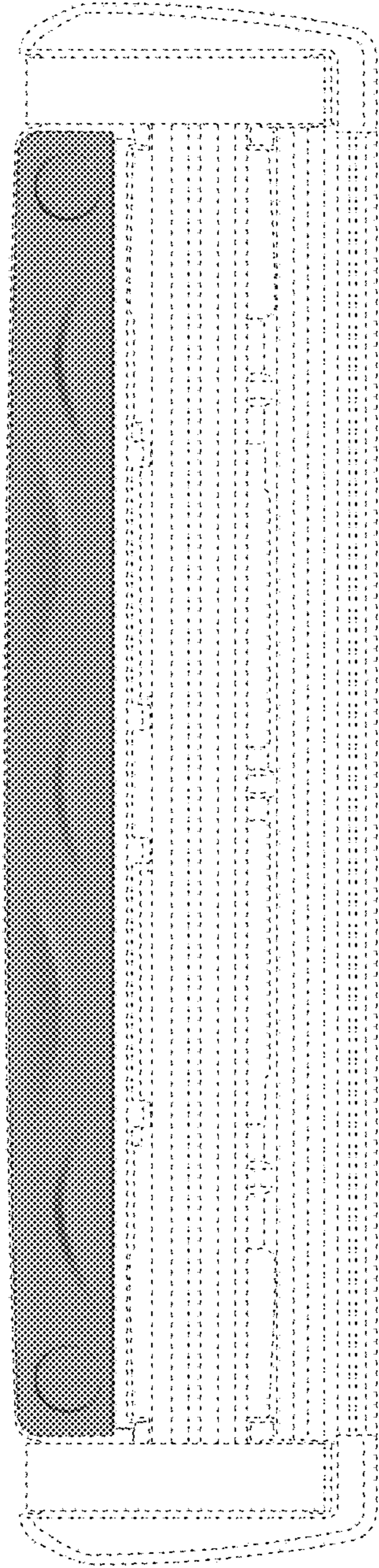

Fig. 9

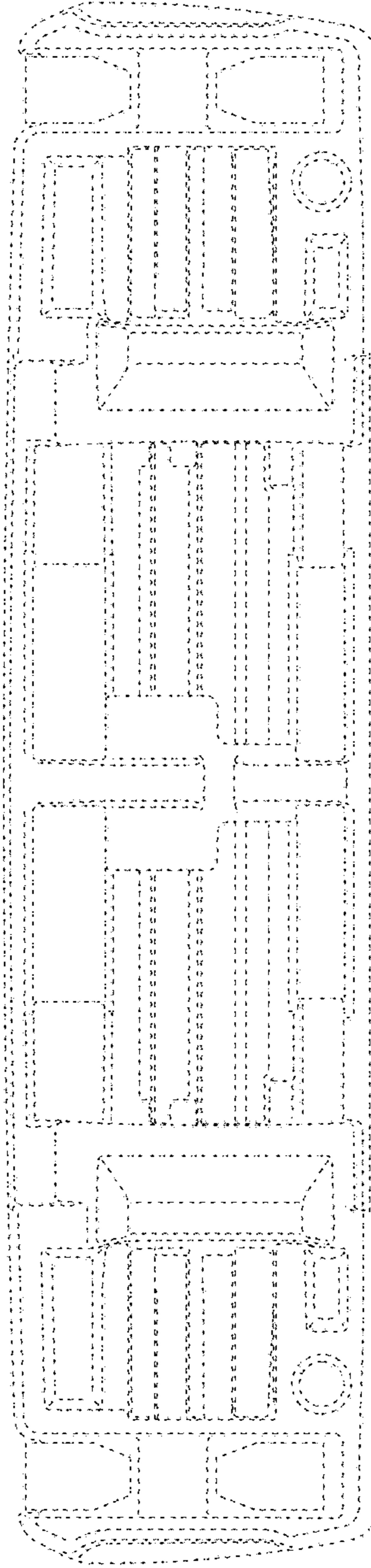
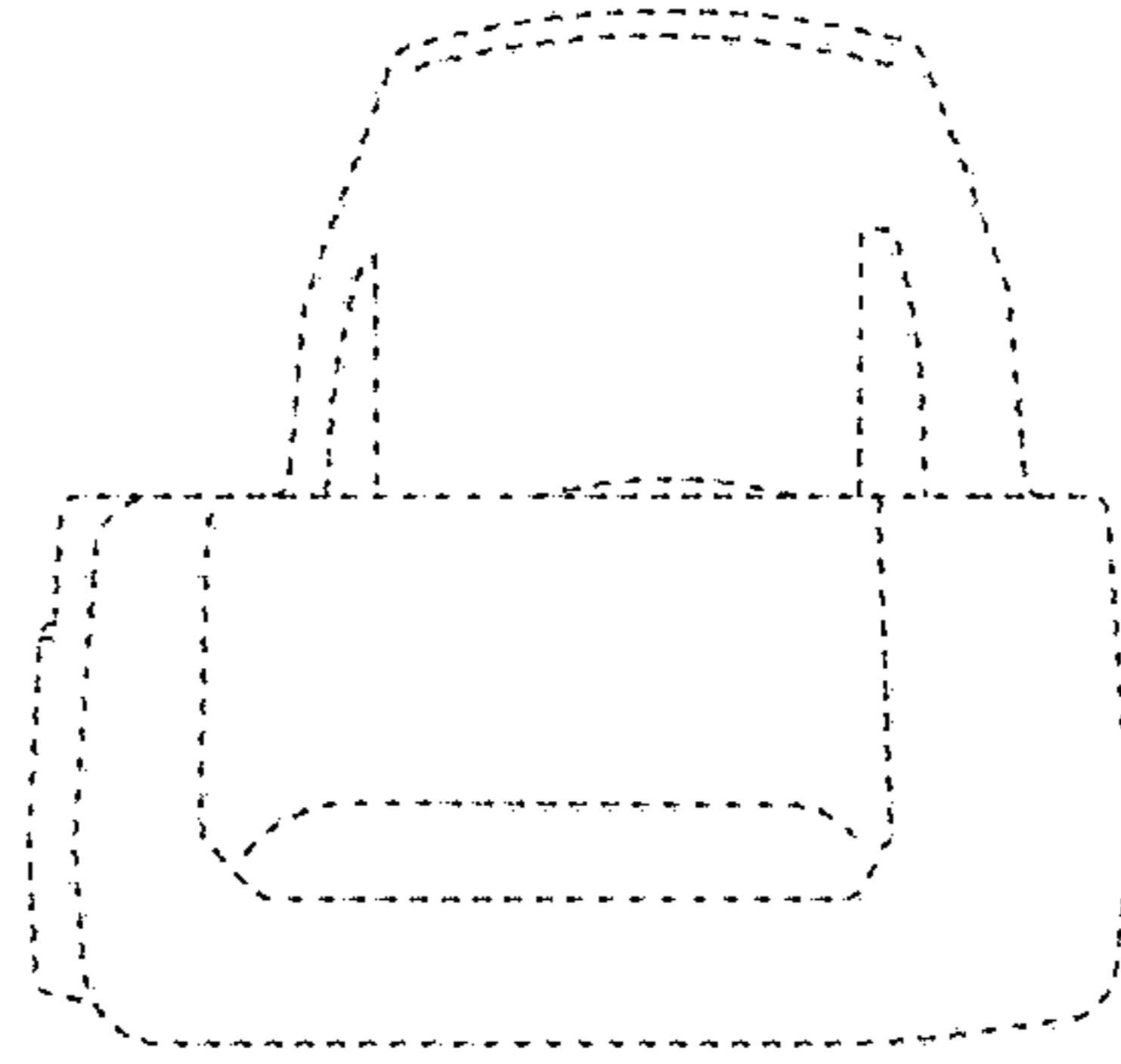
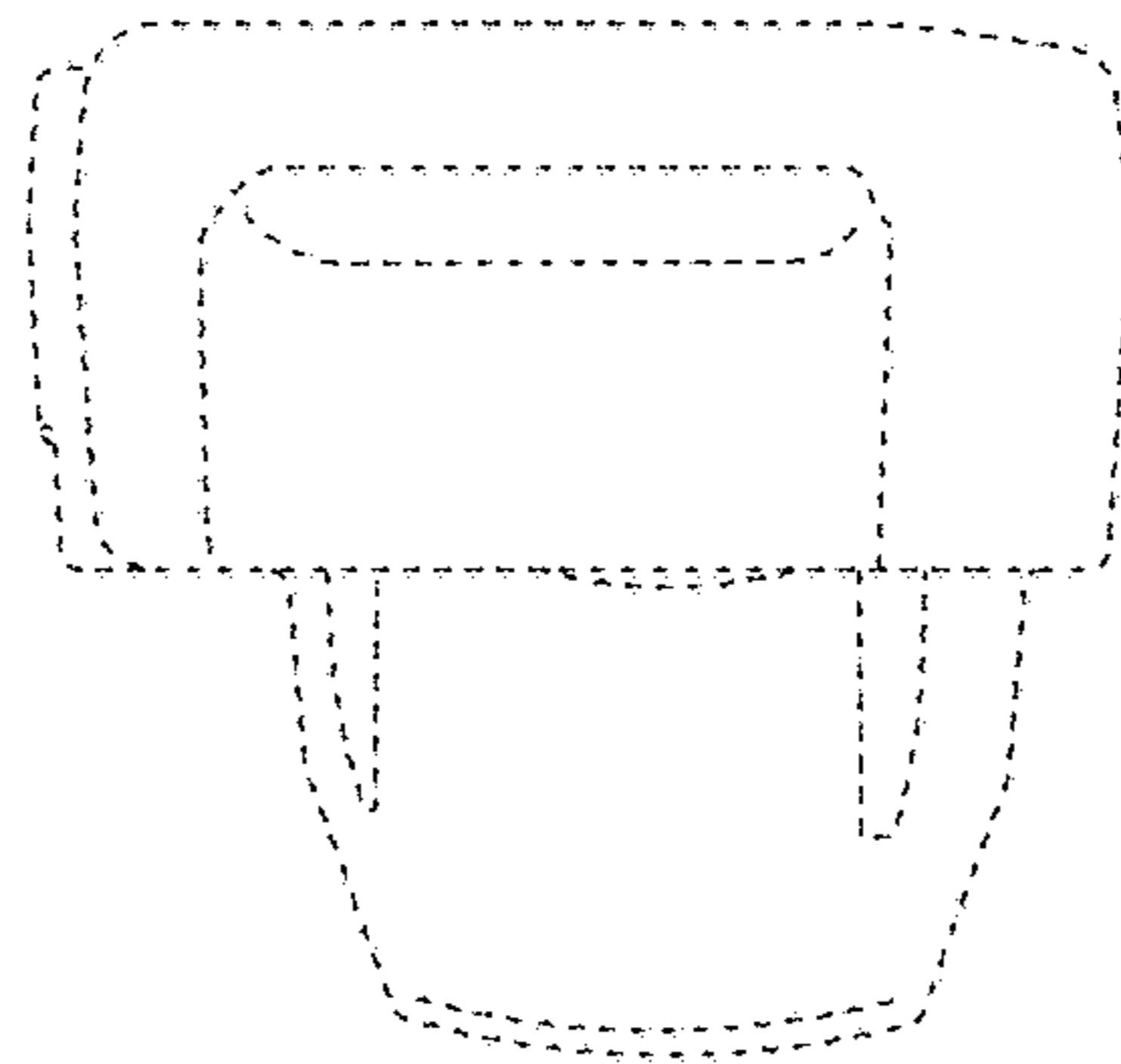

Fig. 10

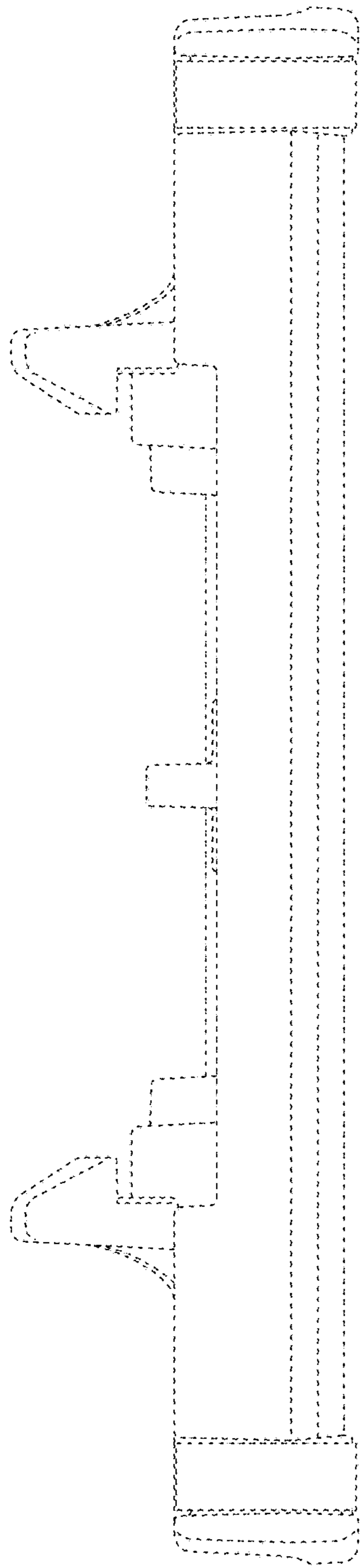



**Fig. 12**



**Fig. 11**



*Fig. 13*

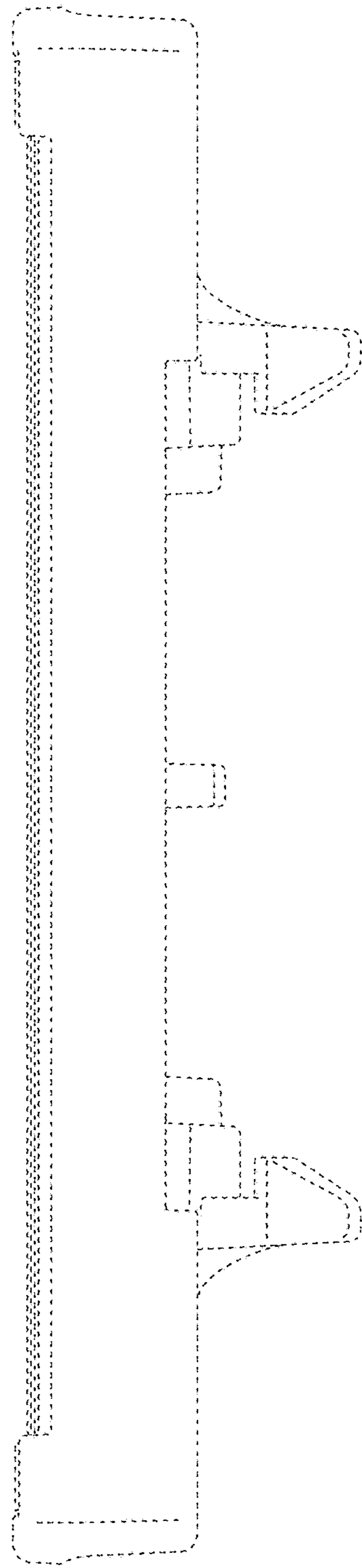

*Fig. 14*

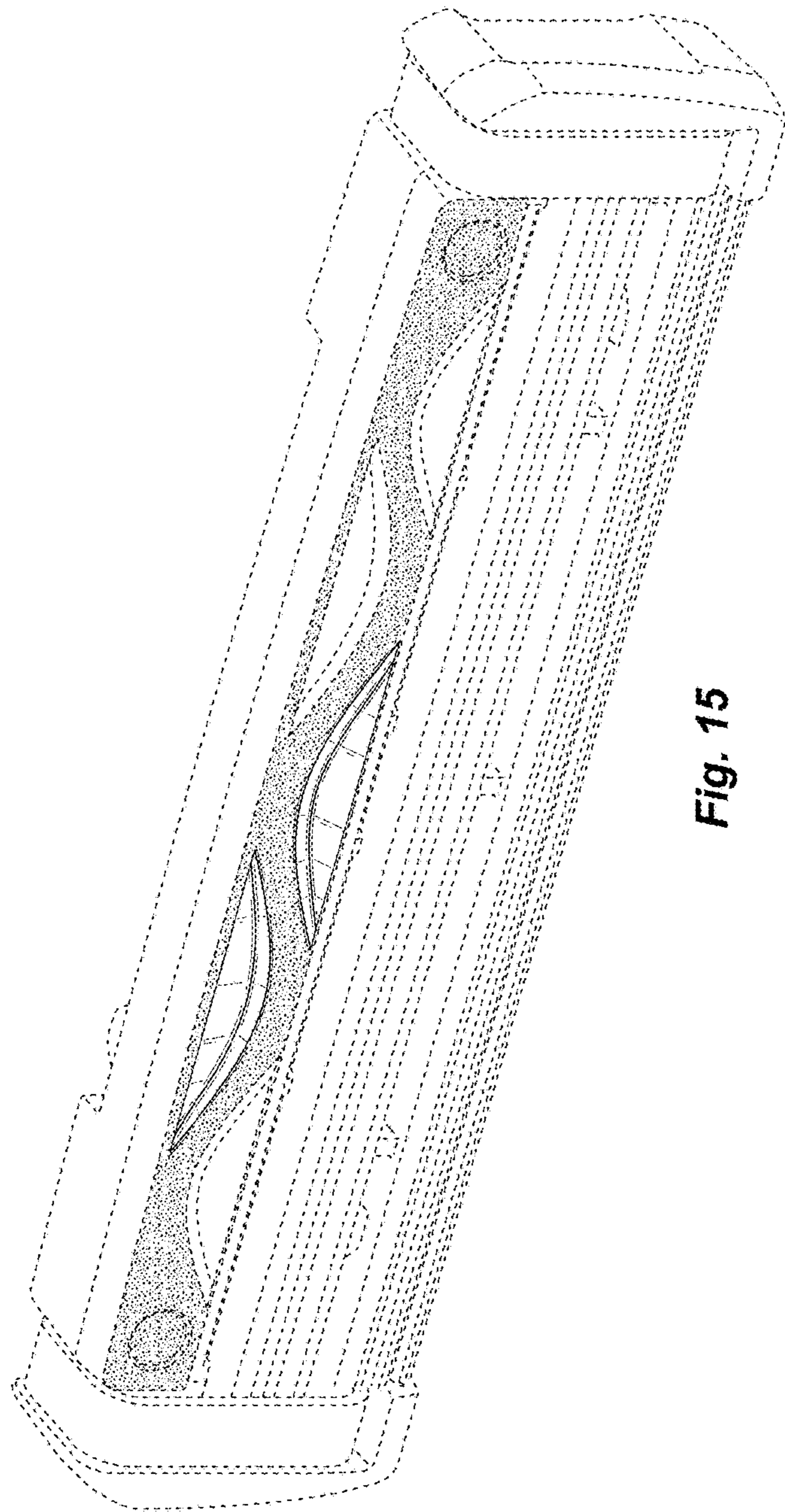

Fig. 15

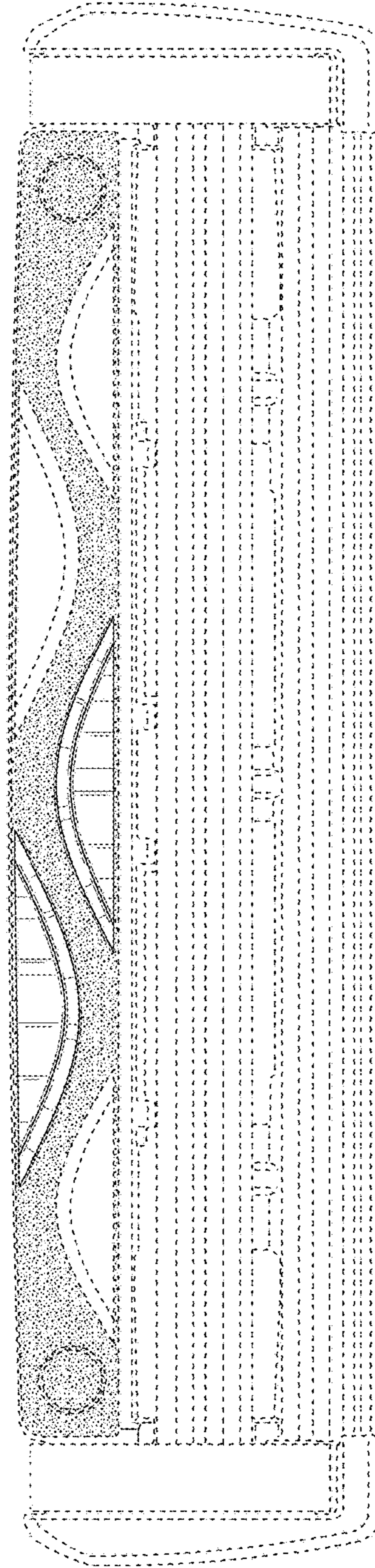

Fig. 16

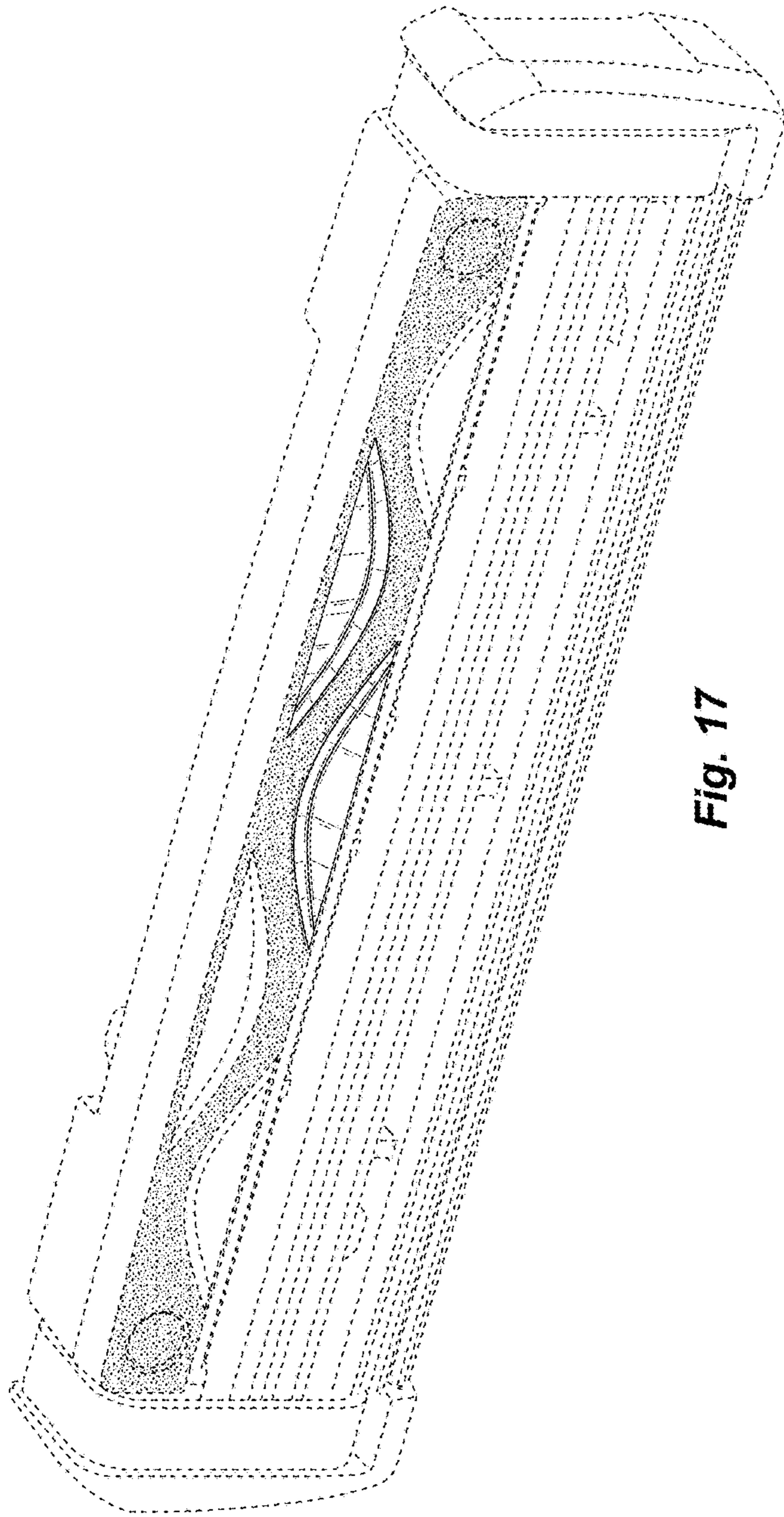

Fig. 17

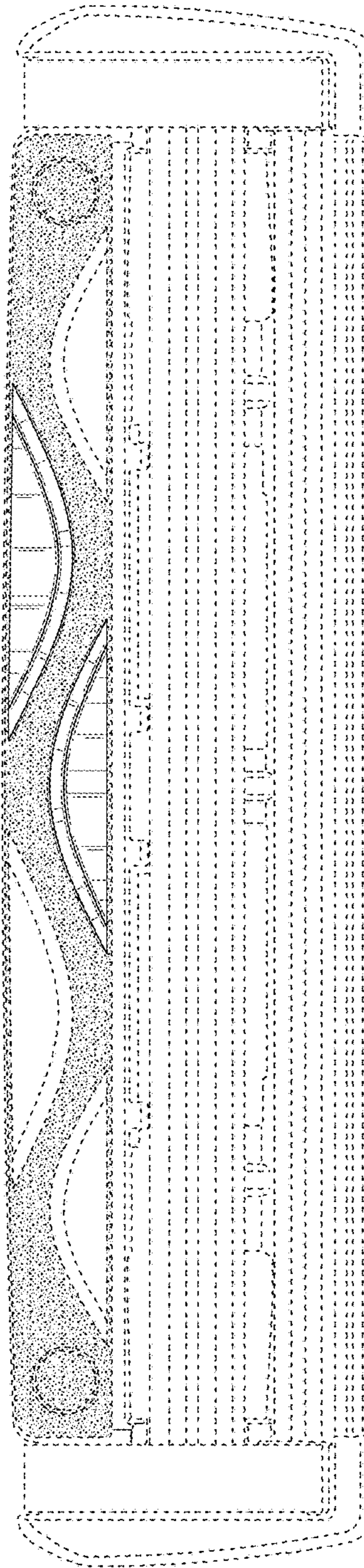

Fig. 18