



US00D867536S

(12) **United States Design Patent** (10) **Patent No.:** **US D867,536 S**
Soulier et al. (45) **Date of Patent:** **** Nov. 19, 2019**

(54) **FAUCET**
(71) Applicant: **Kohler Co.**, Kohler, WI (US)
(72) Inventors: **Jean-Hugues Soulier**, Paris (FR);
Ferran Serra Sola, Paris (FR); **Gaetan Wangon**, Merfy (FR)
(73) Assignee: **KOHLER CO.**, Kohler, WI (US)
(**) Term: **15 Years**
(21) Appl. No.: **29/637,174**
(22) Filed: **Feb. 14, 2018**
(51) **LOC (12) Cl.** **23-01**
(52) **U.S. Cl.**
USPC **D23/241**
(58) **Field of Classification Search**
USPC D23/238–243, 249, 255, 257; D8/305,
D8/311–312; D9/556, 569, 681;
D14/440; D5/56, 2, 58, 60
See application file for complete search history.

(56) **References Cited**
U.S. PATENT DOCUMENTS
D65,415 S * 8/1924 Marple D8/308
D325,771 S * 4/1992 Di Maggio D23/238
D339,629 S 9/1993 Gottwald
D419,643 S 1/2000 Gottwald
D444,851 S 7/2001 Sturgeon
D457,941 S 5/2002 Lobermeier
D471,254 S 3/2003 Bonnell et al.
D475,270 S * 6/2003 Loyd D8/312
D491,633 S * 6/2004 Ouyoung D23/238
D493,211 S 7/2004 Fraser
D514,200 S 1/2006 Starck
D530,783 S 10/2006 Bayer
D531,267 S 10/2006 Hundley
D555,771 S * 11/2007 Noth D23/238

D560,758 S 1/2008 Heck
D623,275 S 9/2010 Rubin et al.
D636,062 S 4/2011 Rubin et al.
D652,898 S * 1/2012 Flowers D23/252
D683,824 S * 6/2013 Eilmus D23/238
D694,366 S 11/2013 Hahn et al.
D696,750 S * 12/2013 Standefer D23/242
D697,590 S * 1/2014 Standefer D23/242
D704,802 S 5/2014 Hahn et al.
D717,918 S * 11/2014 Standefer D23/252
D794,884 S * 8/2017 Ayers D32/28
D801,485 S 10/2017 Kirar et al.
D802,100 S 11/2017 Kirar et al.

(Continued)

Primary Examiner — Robert A Delehanty
(74) *Attorney, Agent, or Firm* — Foley & Lardner LLP

(57) **CLAIM**
We claim the ornamental design for a faucet, as shown and described.

DESCRIPTION
FIG. 1 is a perspective view of another embodiment of the claimed design;
FIG. 2 is a front view of the embodiment of FIG. 1;
FIG. 3 is a rear view of the embodiment of FIG. 1;
FIG. 4 is a side view of the embodiment of FIG. 1;
FIG. 5 is another side view of the embodiment of FIG. 1;
FIG. 6 is a top view of the embodiment of FIG. 1;
FIG. 7 is a bottom view of the embodiment of FIG. 1; and,
FIG. 8 is a partial detail view of the embodiment of FIG. 1.
description.
The ornamental design which is claimed is shown in solid lines in the drawings. The broken lines in the drawings are for illustrative purposes only and form no part of the claimed design. Broken lines formed of unequal length dashes (i.e., dash-dot) define bounds of the claimed design.

1 Claim, 6 Drawing Sheets

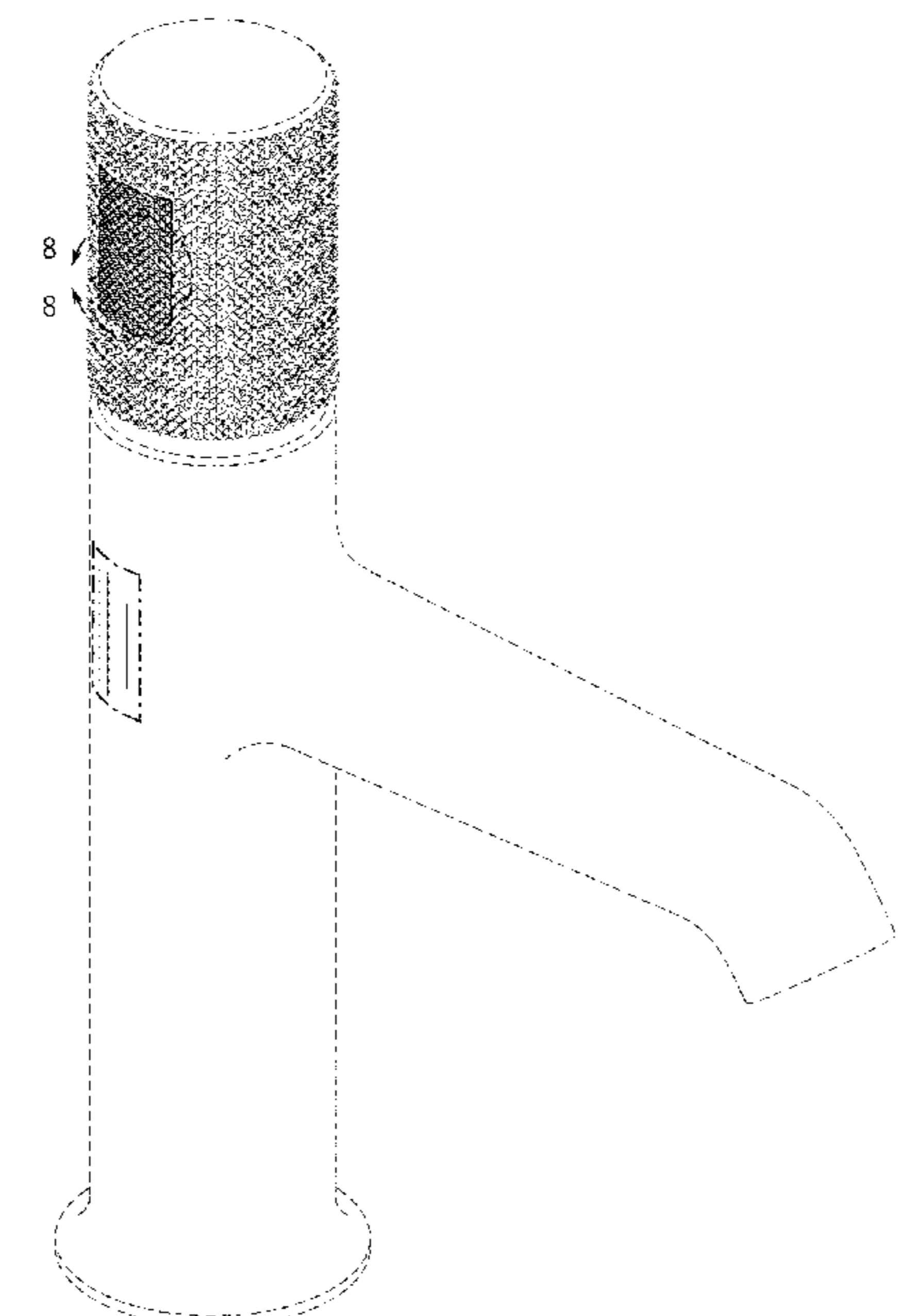

(56)

References Cited

U.S. PATENT DOCUMENTS

D802,101 S	11/2017	Kirar et al.	
D813,986 S *	3/2018	Schoenherr	D23/238
D829,527 S *	10/2018	Kang	D8/311
D834,394 S *	11/2018	Kang	D8/311
10,233,617 B1 *	3/2019	He	E03C 1/0404
D846,701 S *	4/2019	Liu	D23/238
D846,702 S	4/2019	Liu	

* cited by examiner

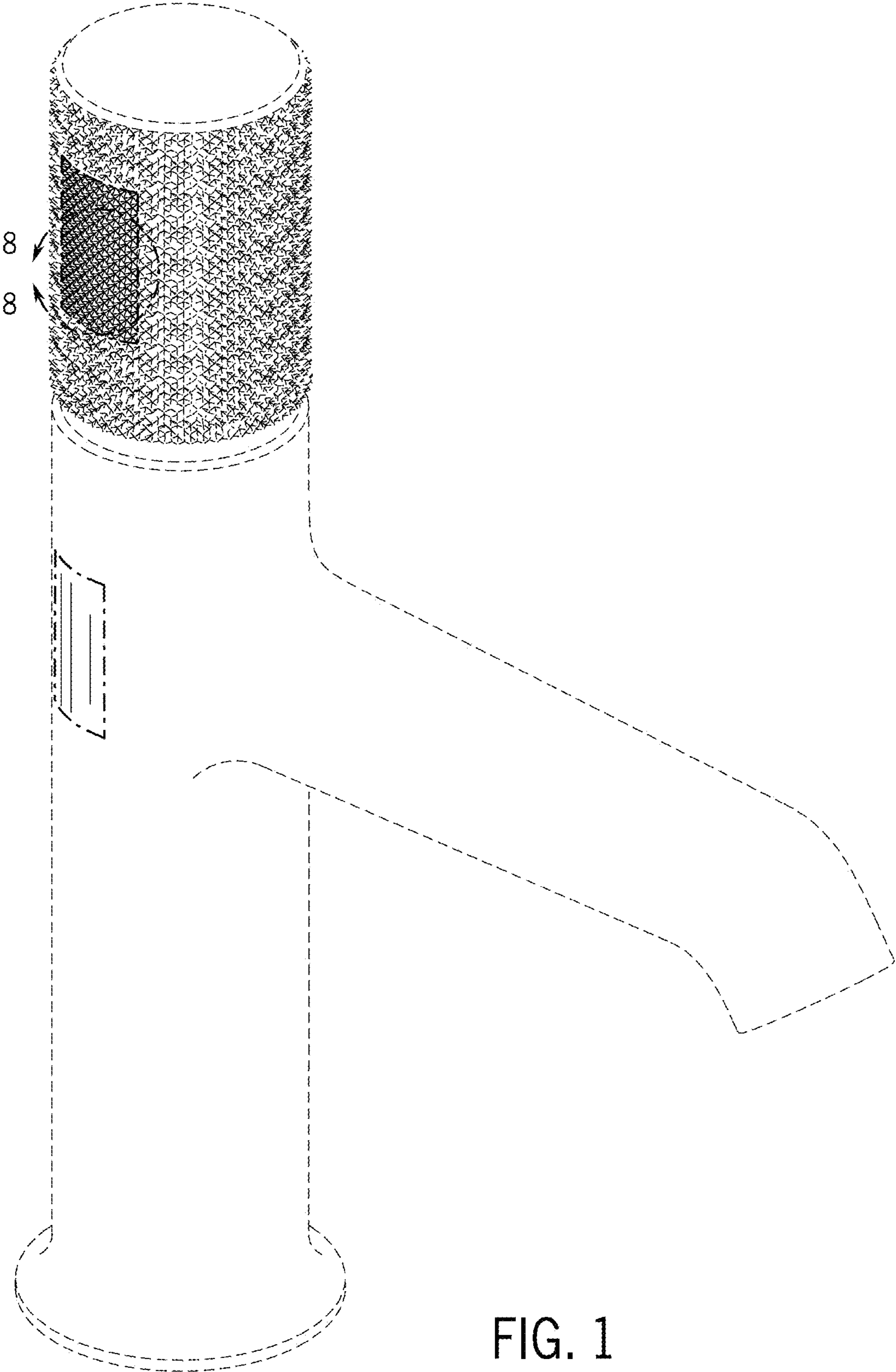

FIG. 1

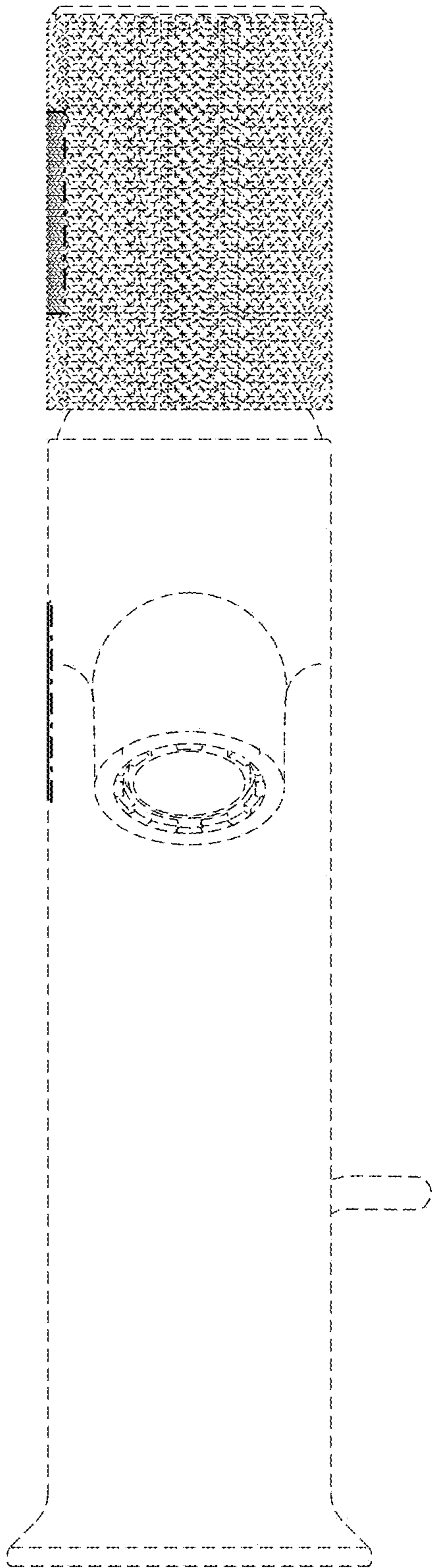

FIG. 2

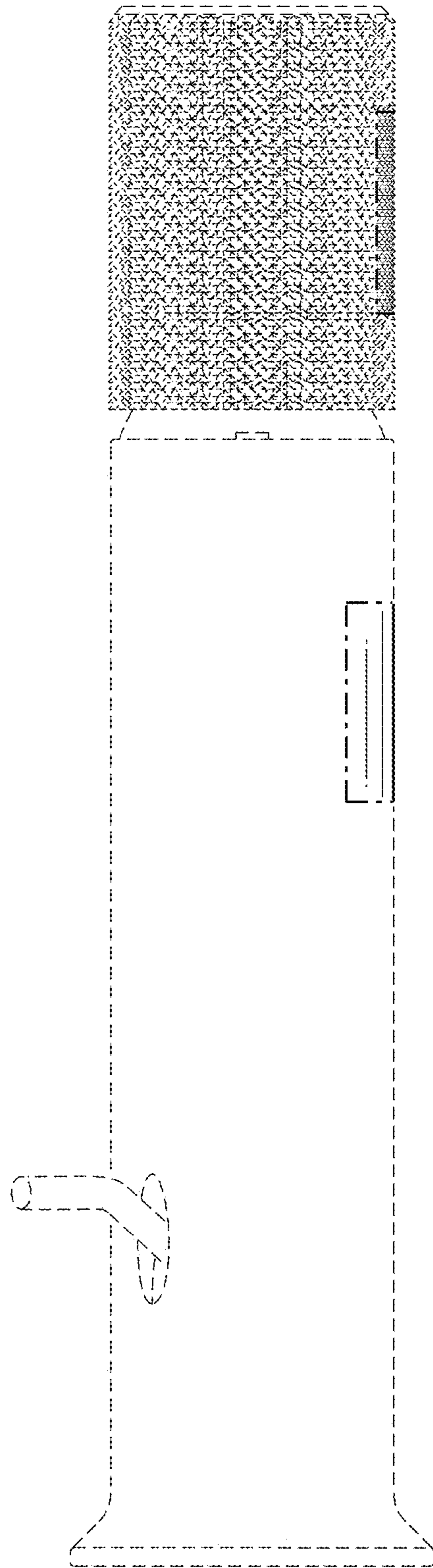

FIG. 3

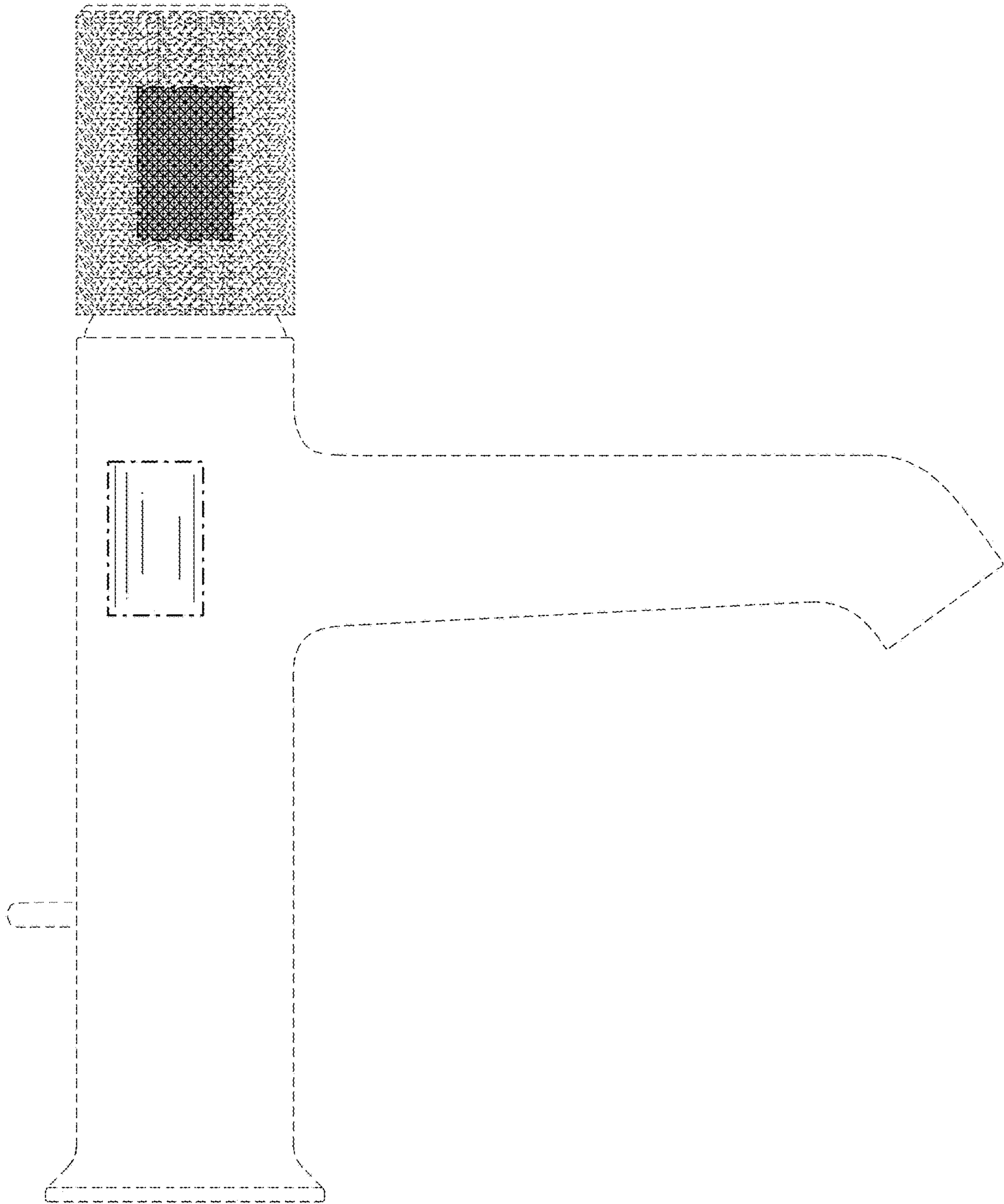

FIG. 4

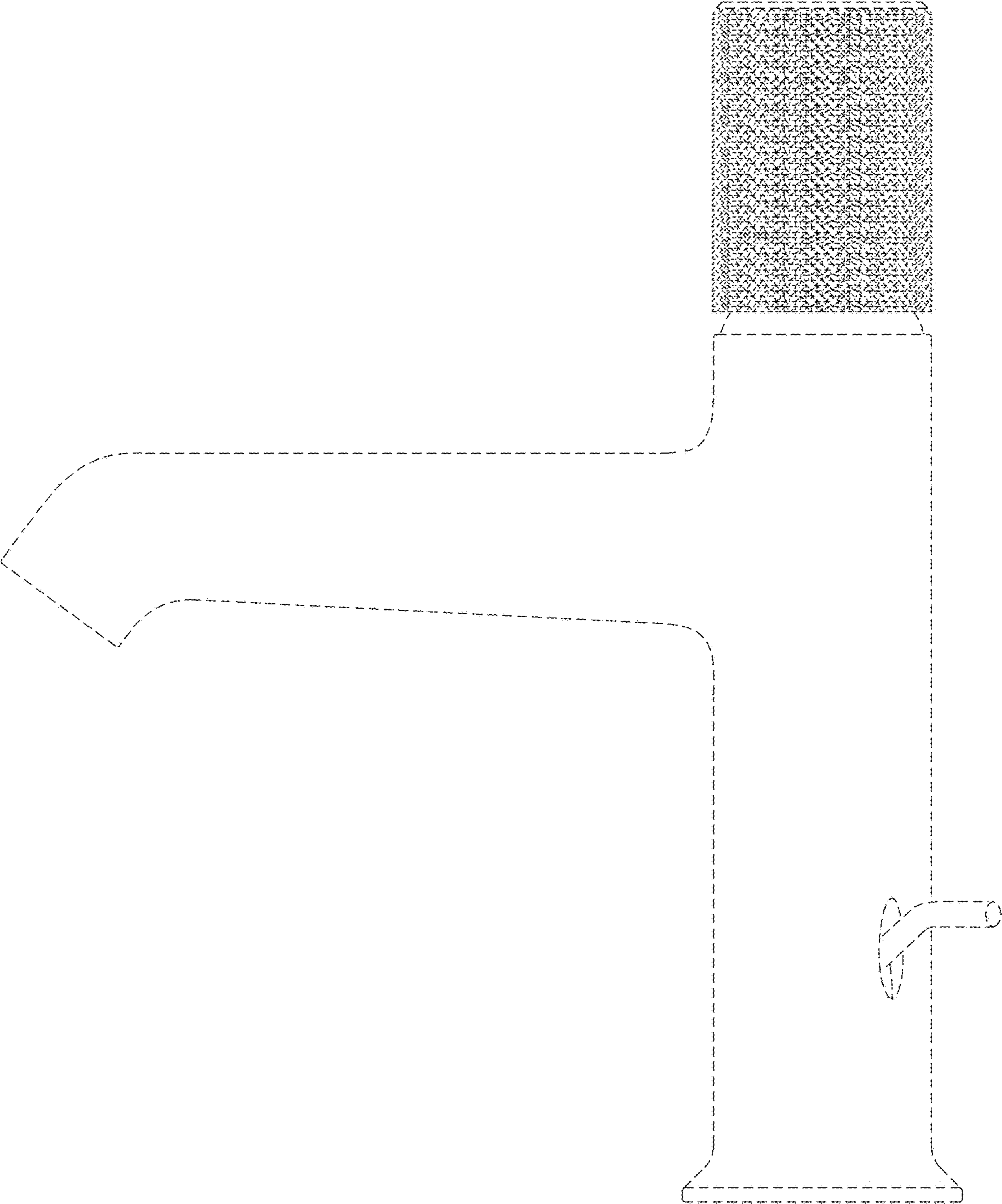

FIG. 5

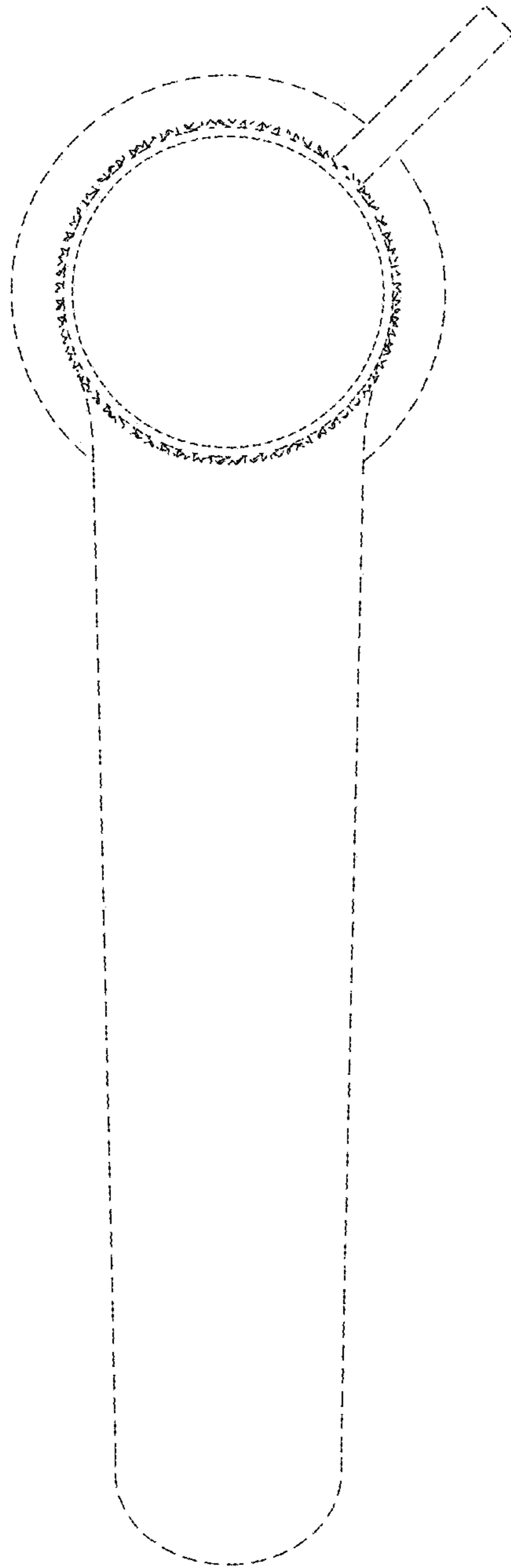

FIG. 6

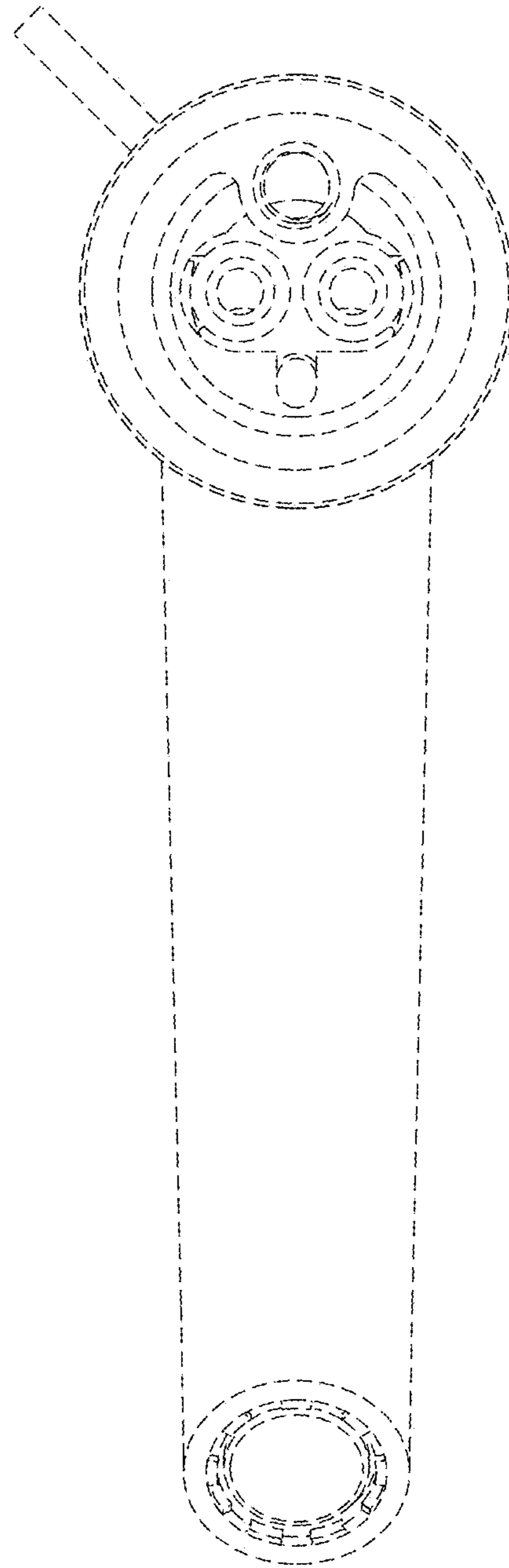

FIG. 7

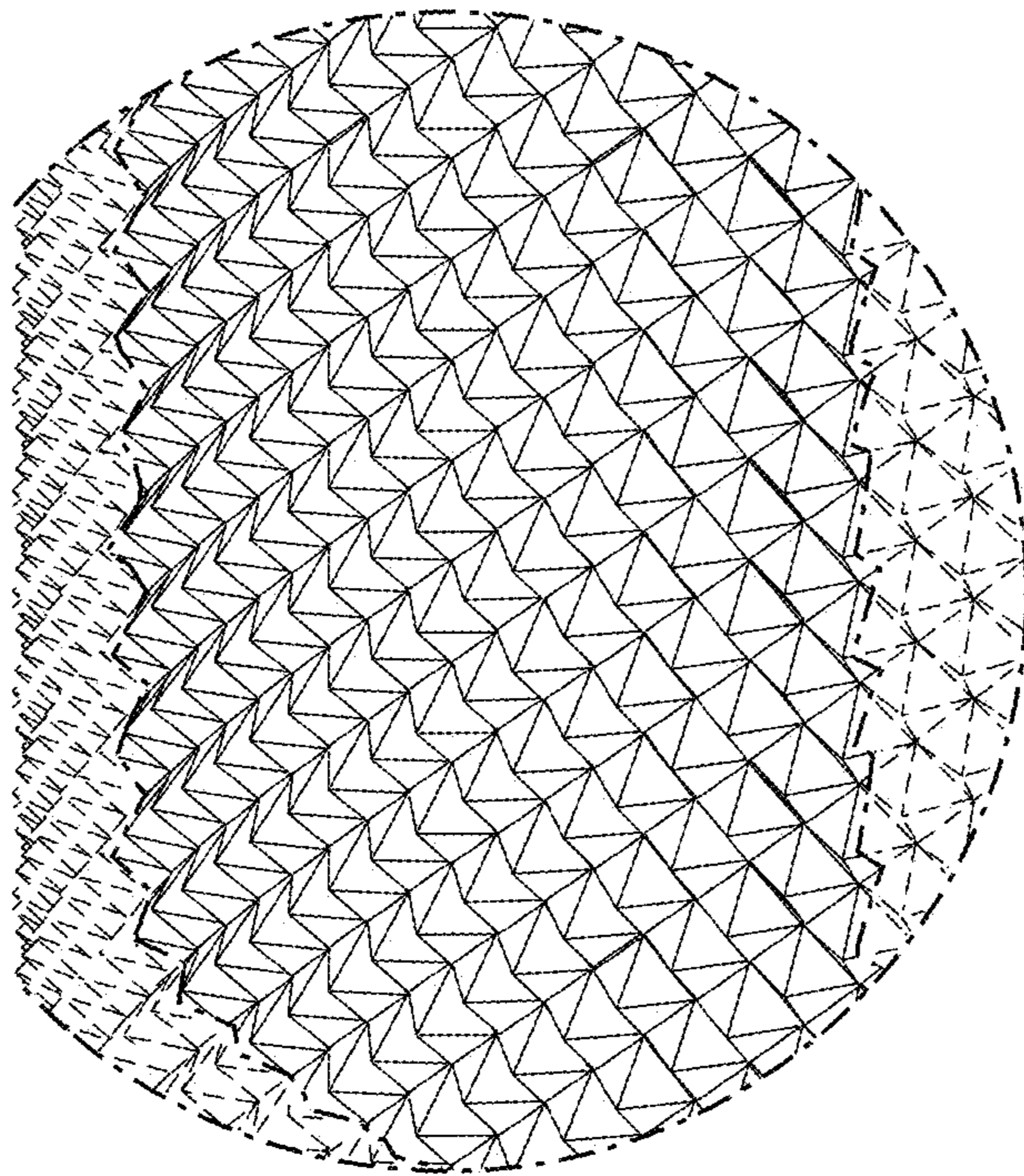

FIG. 8