

US00D867469S

(12) **United States Design Patent** (10) **Patent No.:** **US D867,469 S**  
**Bao** (45) **Date of Patent:** **\*\* Nov. 19, 2019**

(54) **SWING CAR**

(71) Applicant: **Hongzhi Bao**, Taizhou (CN)

(72) Inventor: **Hongzhi Bao**, Taizhou (CN)

(\*\*) Term: **15 Years**

(21) Appl. No.: **29/635,397**

(22) Filed: **Jan. 30, 2018**

(30) **Foreign Application Priority Data**

Jan. 16, 2018 (CN) ..... 2018 3 0018776

(51) **LOC (12) Cl.** ..... **21-01**

(52) **U.S. Cl.**  
USPC ..... **D21/424**

(58) **Field of Classification Search**  
USPC ..... D12/86, 88, 90-92, 164, 173, 184-186,  
D12/190, 196; D21/419, 421, 423-426,  
D21/433-434, 548, 549, 550, 552, 559,  
D21/561

CPC .... A63H 17/26; A63H 17/262; A63H 17/264;  
A63H 17/266; A63H 17/36; A63H 17/38;  
A63H 29/00; A63H 29/22; A63H 29/24;  
A63H 30/04

See application file for complete search history.

(56) **References Cited**

**U.S. PATENT DOCUMENTS**

D469,820 S \* 2/2003 Lanchais ..... D21/424  
D485,871 S \* 1/2004 Horchler ..... D21/424

D537,889 S \* 3/2007 Nakai ..... D21/424  
D631,102 S \* 1/2011 Jessie, Jr. .... D21/423  
D653,294 S \* 1/2012 Loveland ..... D21/419  
D701,271 S \* 3/2014 Grout ..... D21/419  
D719,618 S \* 12/2014 Herlitz ..... D21/424  
D725,196 S \* 3/2015 Child ..... D21/426  
D725,711 S \* 3/2015 Herlitz ..... D21/426  
D795,966 S \* 8/2017 Lee ..... D21/424  
2005/0006865 A1 \* 1/2005 Bao ..... B62K 9/02  
280/87.01  
2011/0266767 A1 \* 11/2011 Bao ..... B62K 9/00  
280/249

\* cited by examiner

*Primary Examiner* — Manpreet S Matharu

*Assistant Examiner* — Keith J Wilson

(74) *Attorney, Agent, or Firm* — Gokalp Bayramoglu

(57) **CLAIM**

The ornamental design for a swing car, as shown and described.

**DESCRIPTION**

FIG. 1 is a perspective view of a swing car showing my new design;

FIG. 2 is a right side view thereof;

FIG. 3 is a left side view thereof;

FIG. 4 is a front view thereof;

FIG. 5 is a rear view thereof;

FIG. 6 is a top view thereof; and,

FIG. 7 is a bottom view thereof.

The broken lines shown depict portions of a swing car that form no part of the claimed design.

**1 Claim, 7 Drawing Sheets**

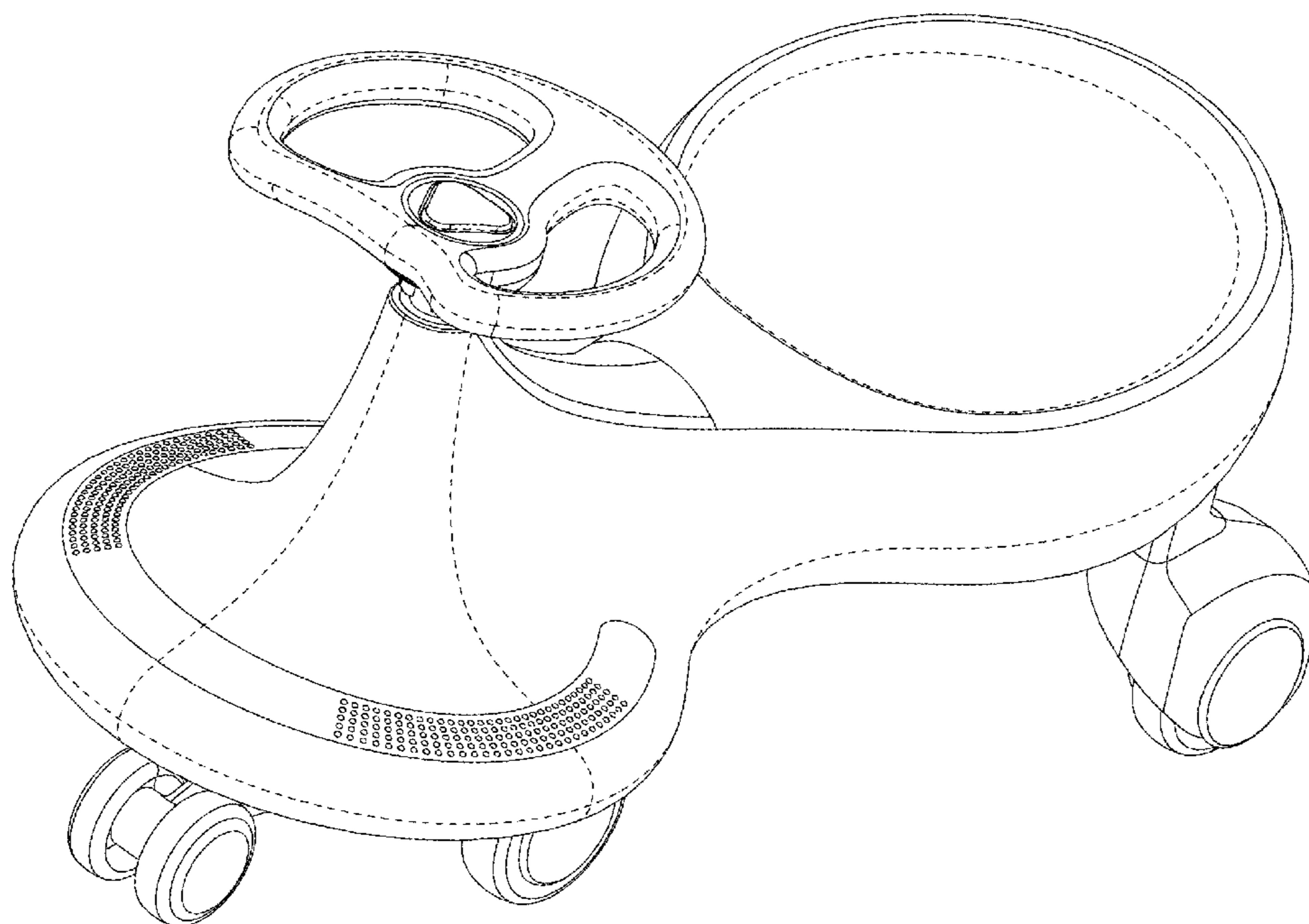

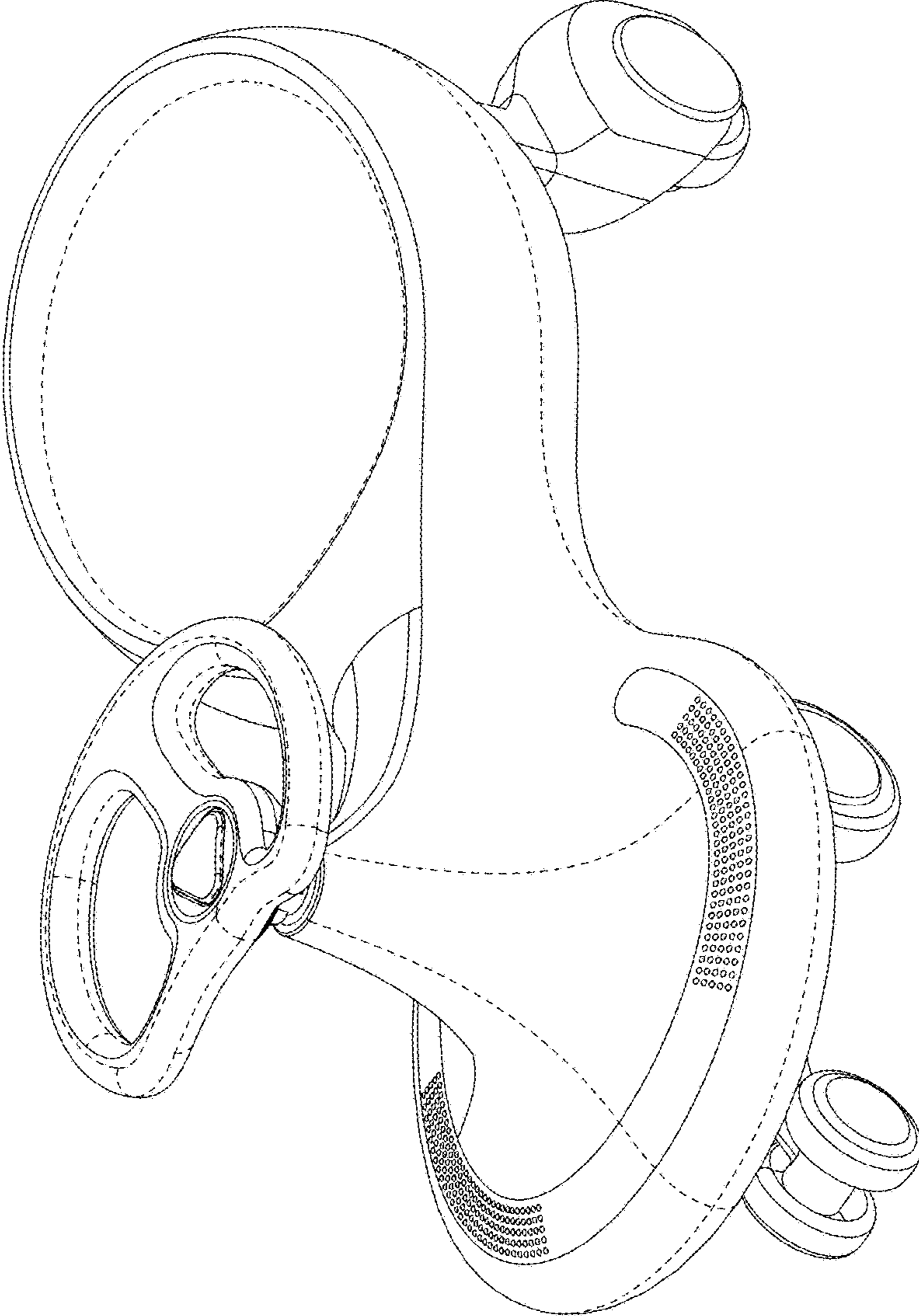

FIG. 1

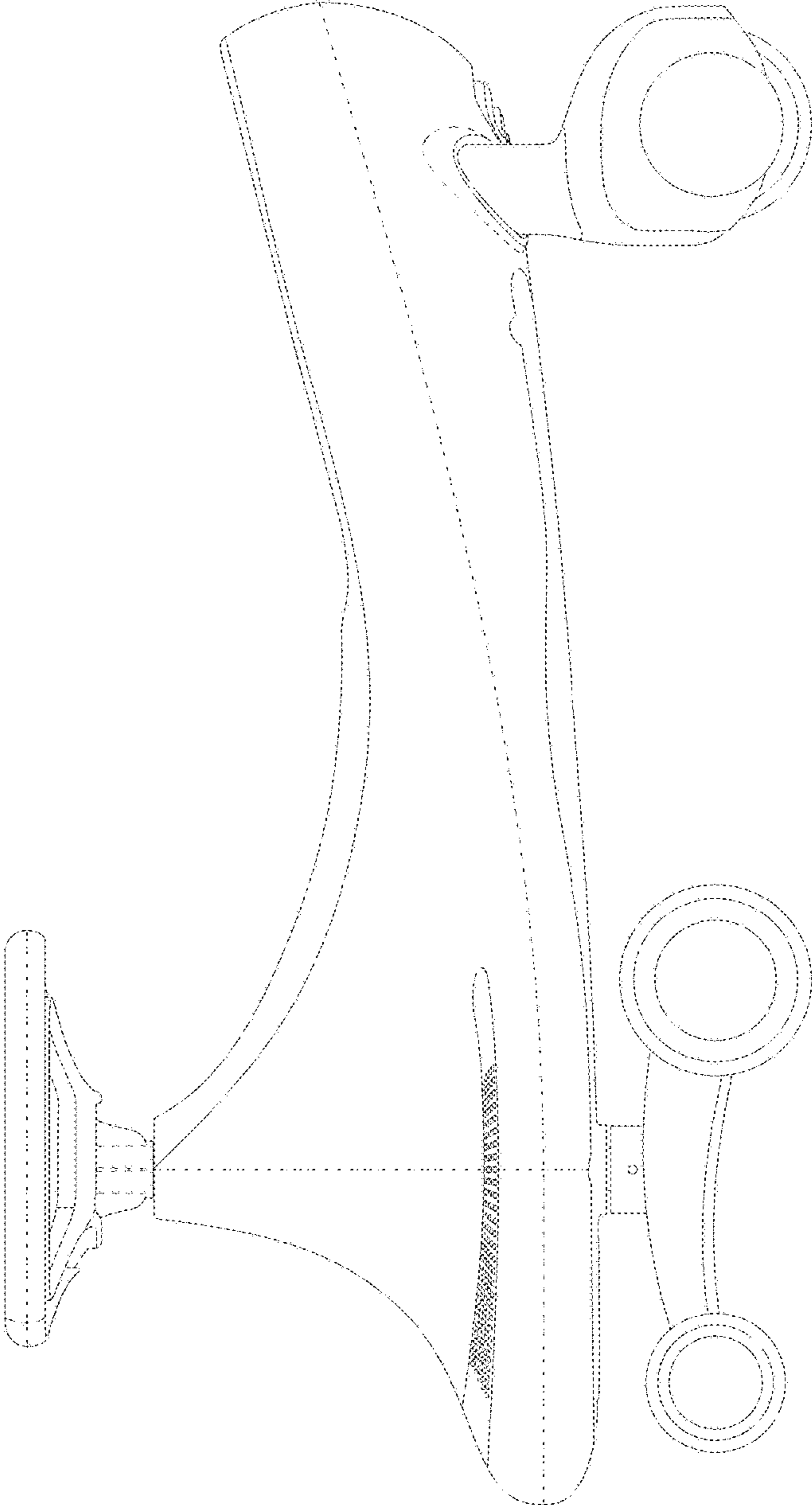

FIG. 2

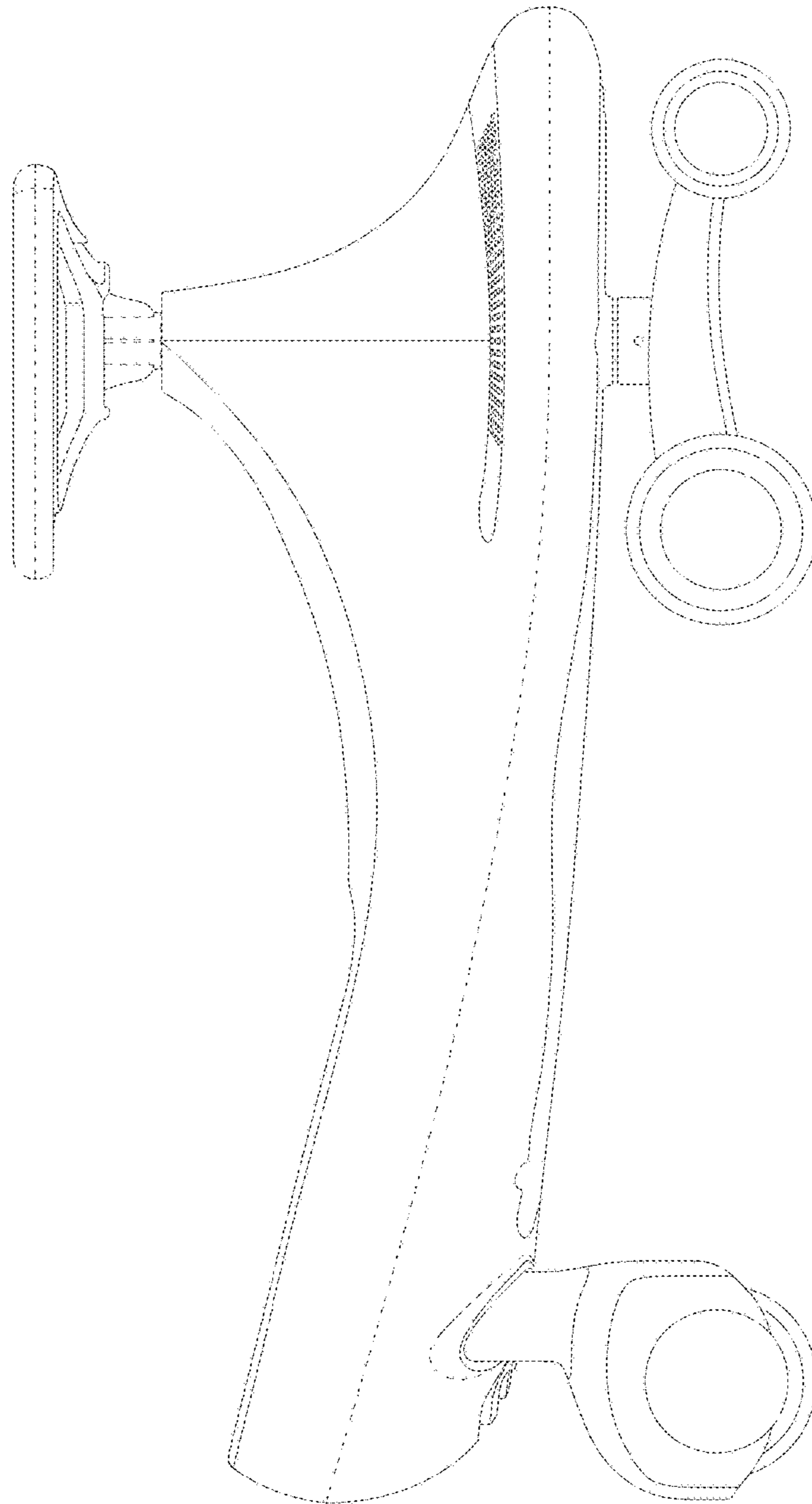

FIG. 3

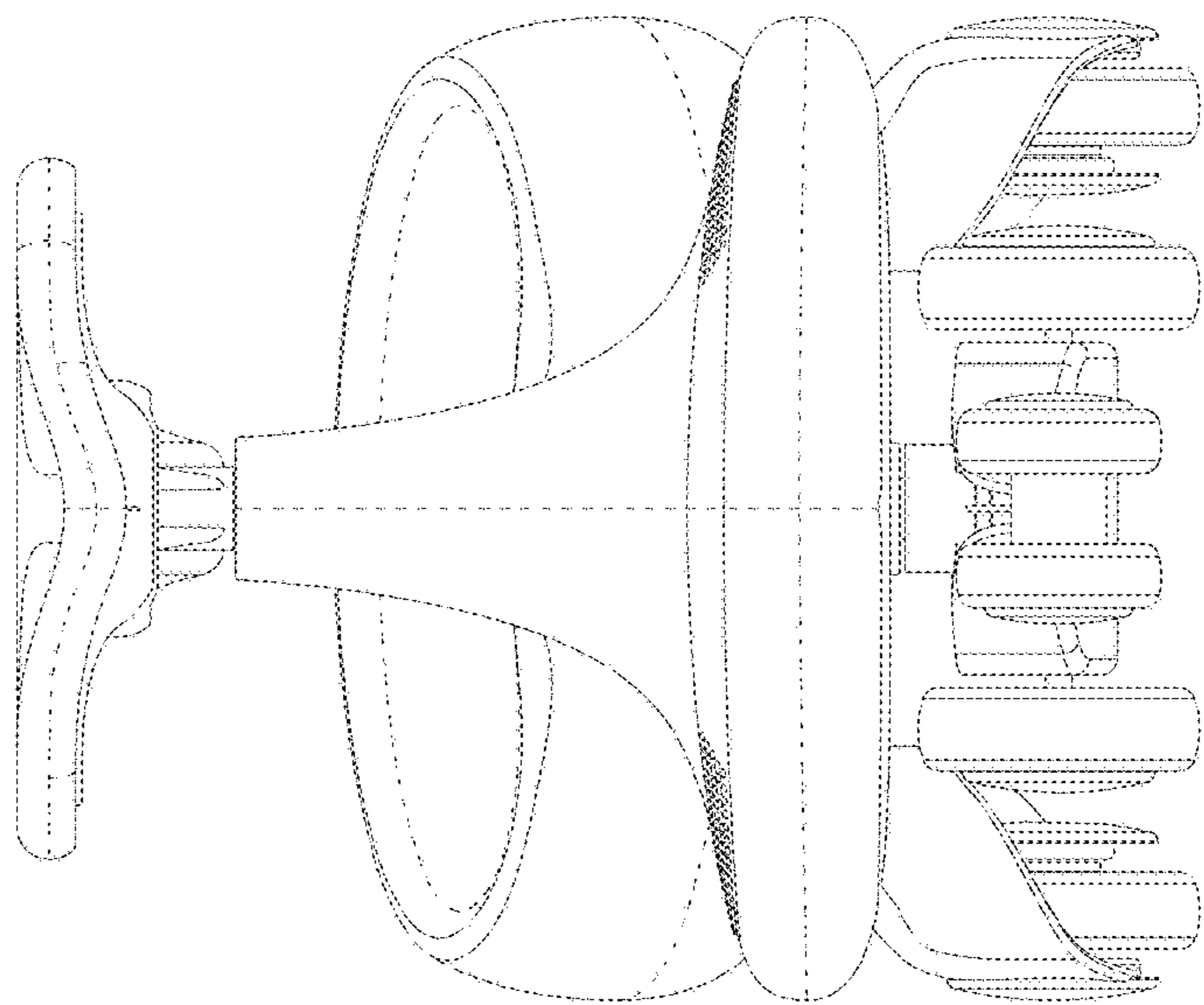

FIG. 4

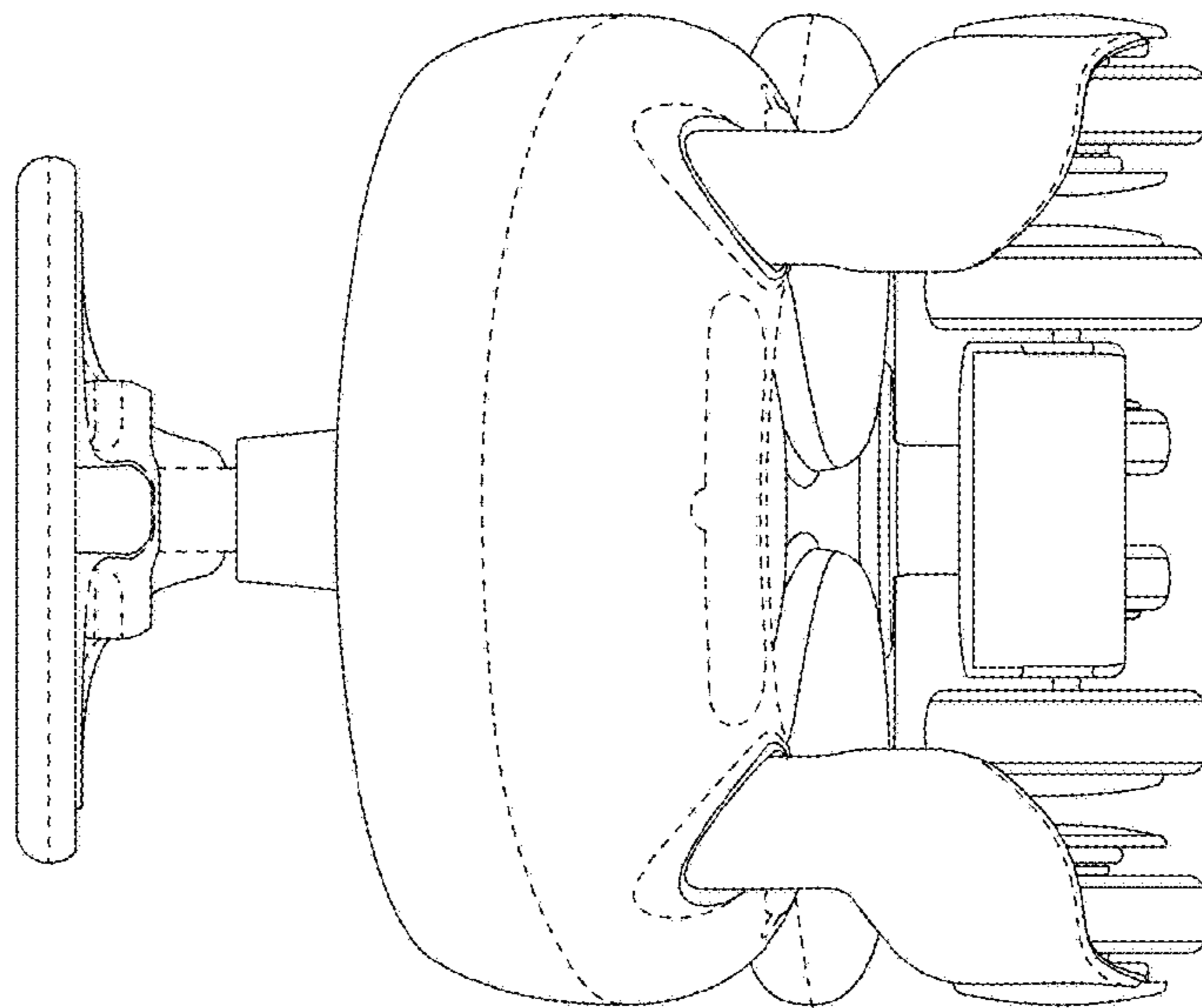

FIG. 5

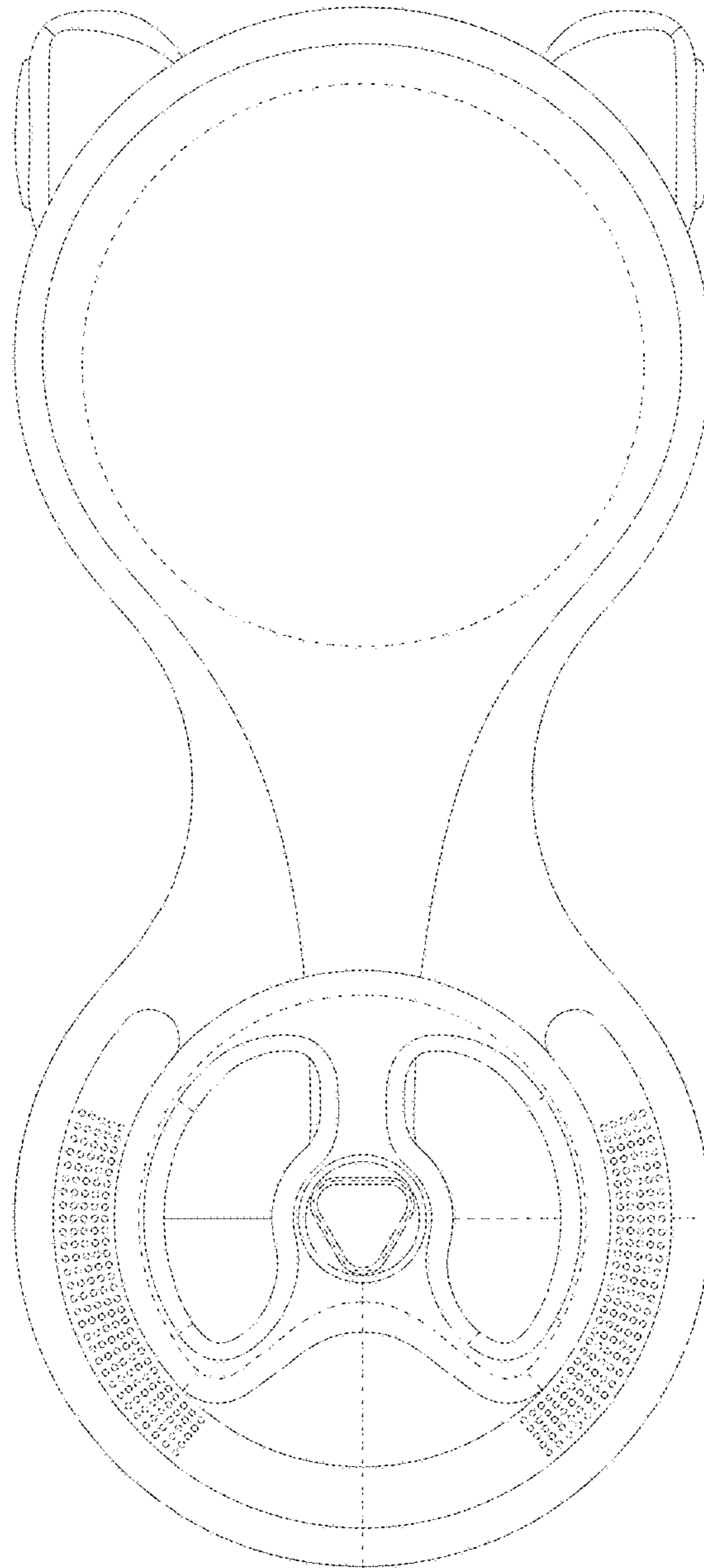

FIG. 6

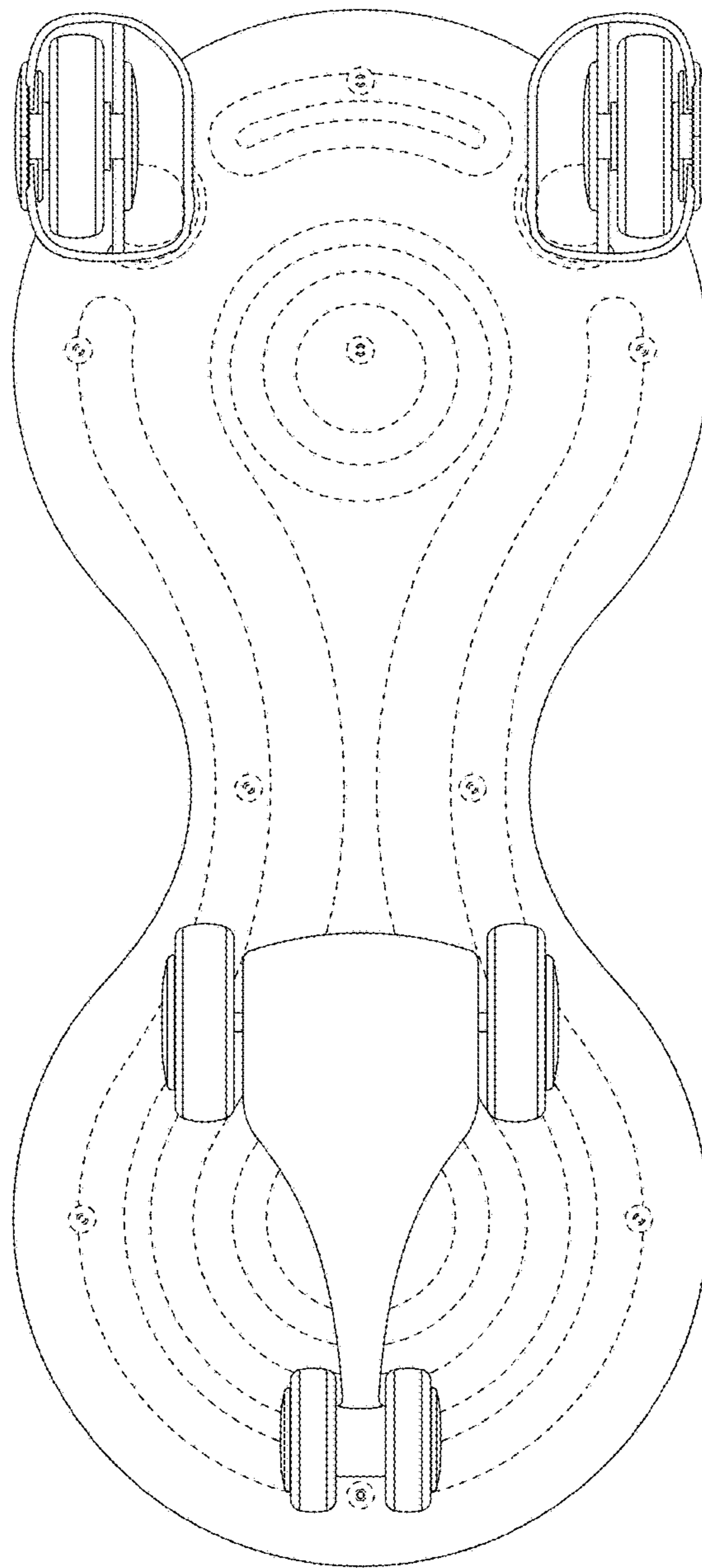

FIG. 7