

US00D867295S

(12) **United States Design Patent**
Shaopeng

(10) **Patent No.:** **US D867,295 S**

(45) **Date of Patent:** **** Nov. 19, 2019**

(54) **PLUG ADAPTER**

(71) Applicant: **Zhuhai Lihe Technology Co., Ltd.**,
Zhuhai (CN)

(72) Inventor: **Lyu Shaopeng**, Shantou (CN)

(**) Term: **15 Years**

(21) Appl. No.: **29/668,657**

(22) Filed: **Oct. 31, 2018**

(51) **LOC (12) Cl.** **13-03**

(52) **U.S. Cl.**

USPC **D13/137.2**

(58) **Field of Classification Search**

USPC D13/137.1–137.4, 138.1–138.2,
D13/139.1–139.8, 110, 108; D14/240;
D26/26

CPC H01R 13/5219; H01R 31/06
See application file for complete search history.

D677,221 S *	3/2013	McSweyn	D13/108
D683,310 S *	5/2013	McSweyn	D13/108
D713,788 S *	9/2014	Hasegawa	D13/110
9,106,037 B2 *	8/2015	Lee	H01R 31/06
D751,038 S *	3/2016	Lin	D13/137.2
D755,127 S *	5/2016	Wong	D13/137.2
D807,295 S *	1/2018	Xu	D13/137.2
D808,046 S *	1/2018	Jianting	D26/26
D816,614 S *	5/2018	An	D13/137.1
9,985,397 B2 *	5/2018	Jiang	H01R 13/5219
D823,844 S *	7/2018	Ramones	D14/240
D825,458 S *	8/2018	Nauroy	D13/108
D858,439 S *	9/2019	Li	D13/108
D859,311 S *	9/2019	Liao	D13/137.3

* cited by examiner

Primary Examiner — Rhea Shields

(57) **CLAIM**

The ornamental design for an plug adapter, as shown and described.

DESCRIPTION

FIG. 1 is a front perspective view of a plug adapter showing my new design;

FIG. 2 is a front elevational view thereof;

FIG. 3 is a rear elevational view thereof;

FIG. 4 is a left side elevational view thereof;

FIG. 5 is a right side elevational view thereof;

FIG. 6 is a top plan view thereof; and,

FIG. 7 is a bottom plan view thereof.

1 Claim, 7 Drawing Sheets

(56) **References Cited**

U.S. PATENT DOCUMENTS

D370,204 S	5/1996	Kittridge	
D450,036 S *	11/2001	Okamoto D13/137.2
D533,836 S	12/2006	Young	
D638,357 S *	5/2011	Sasada D13/110
8,157,578 B2 *	4/2012	Lee H01R 31/06 439/172
D665,348 S *	8/2012	Ledbetter D13/110
D676,382 S *	2/2013	McSweyn D13/108

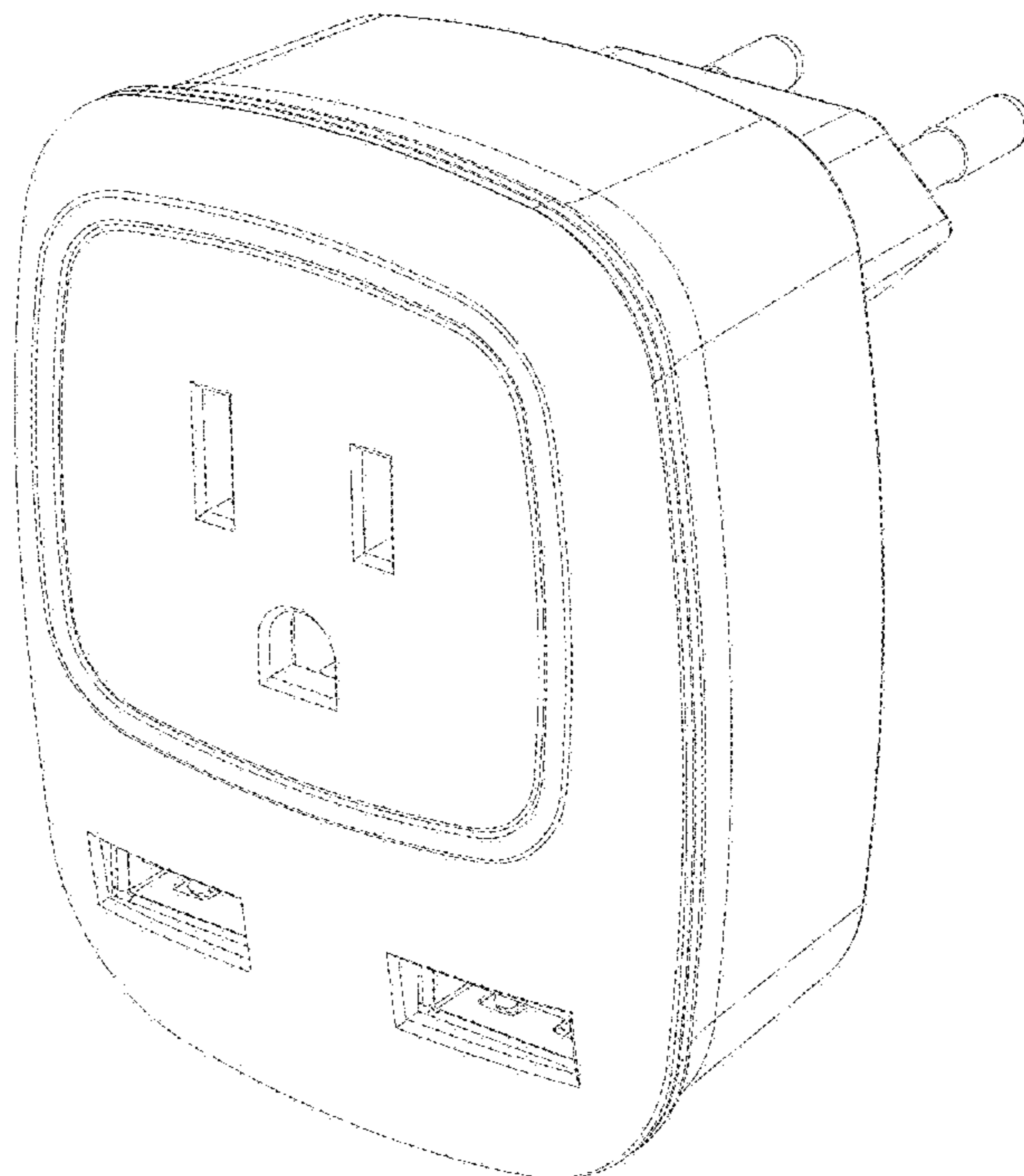

FIG. 1

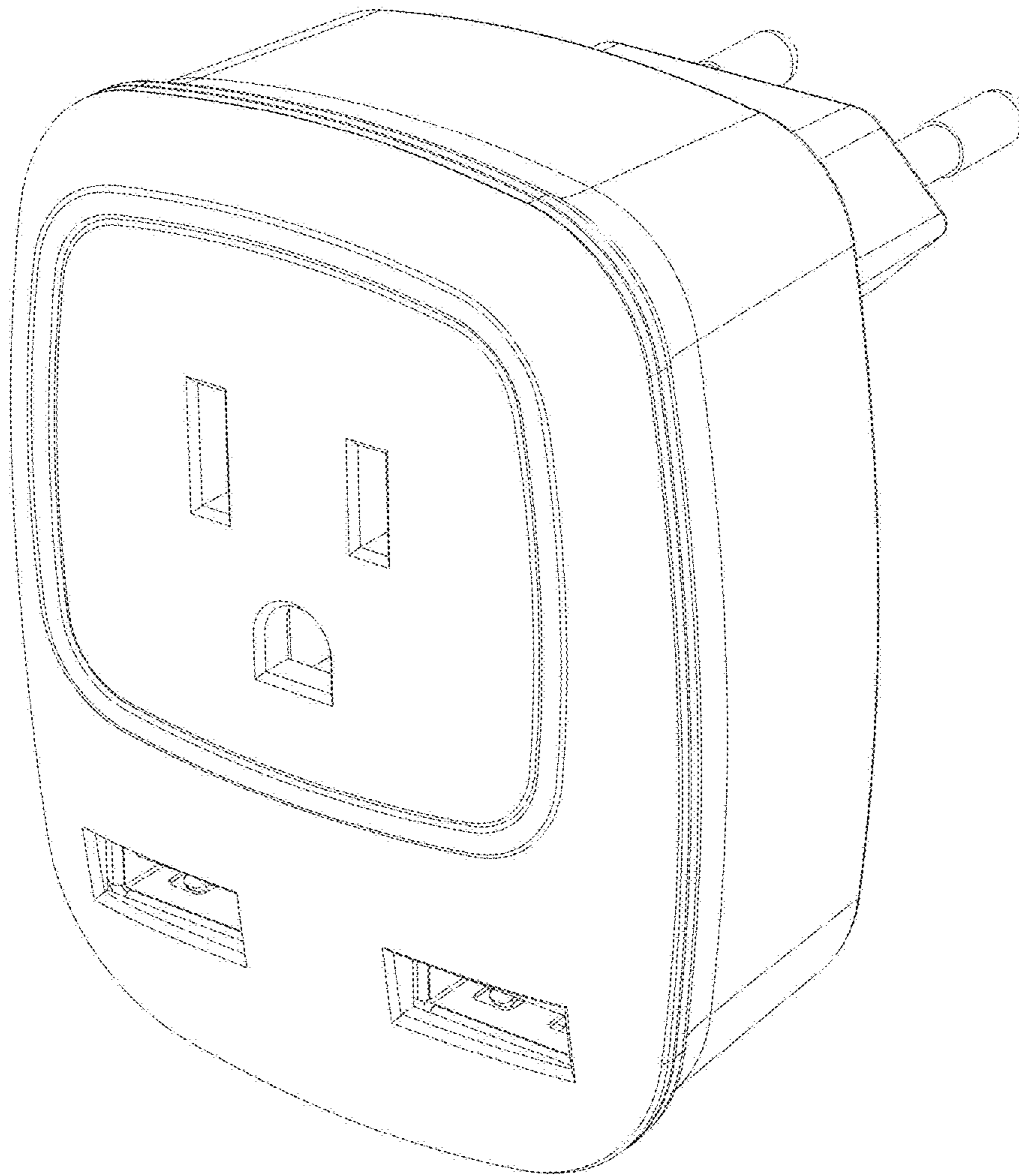

FIG. 2

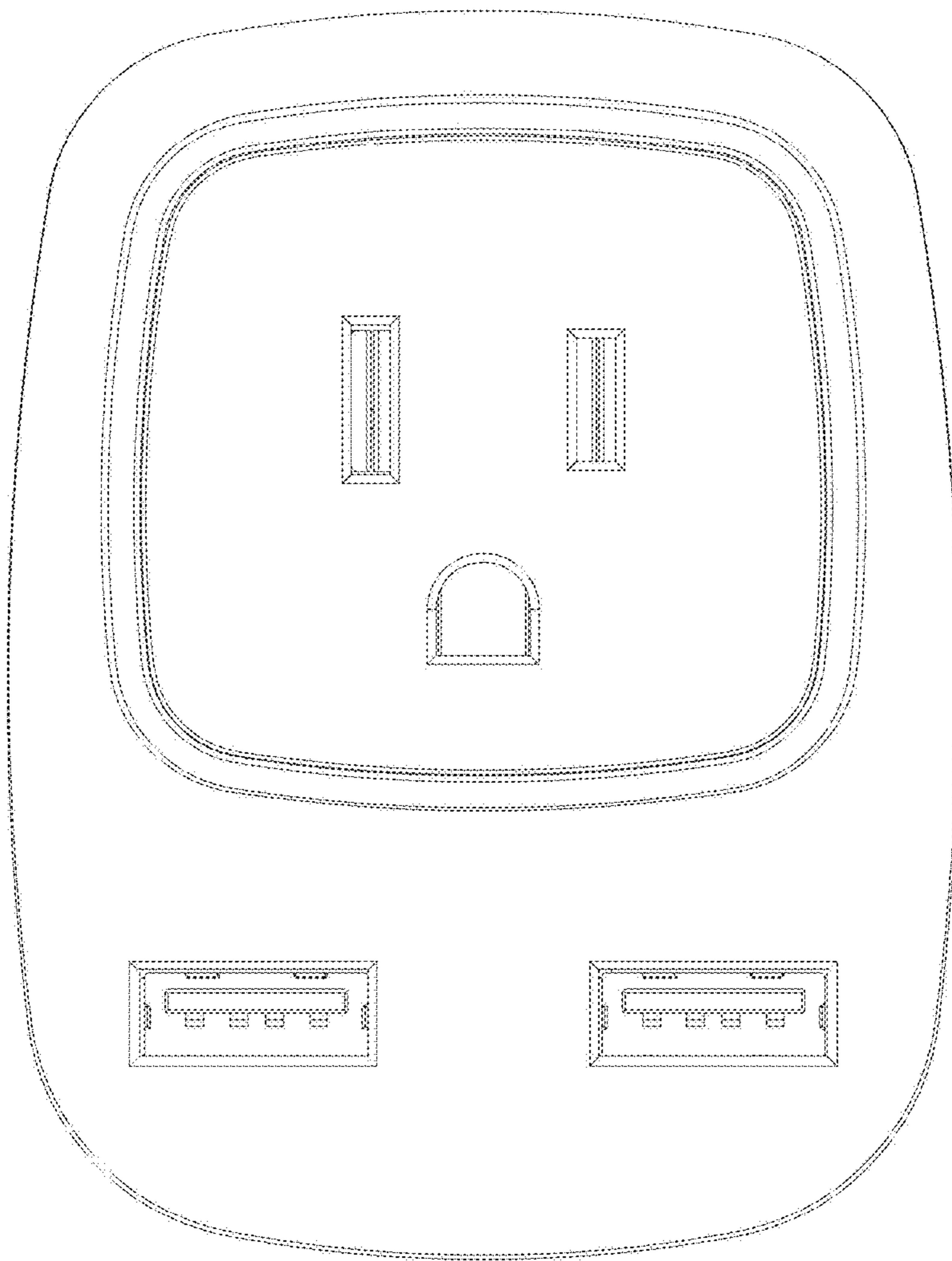

FIG. 3

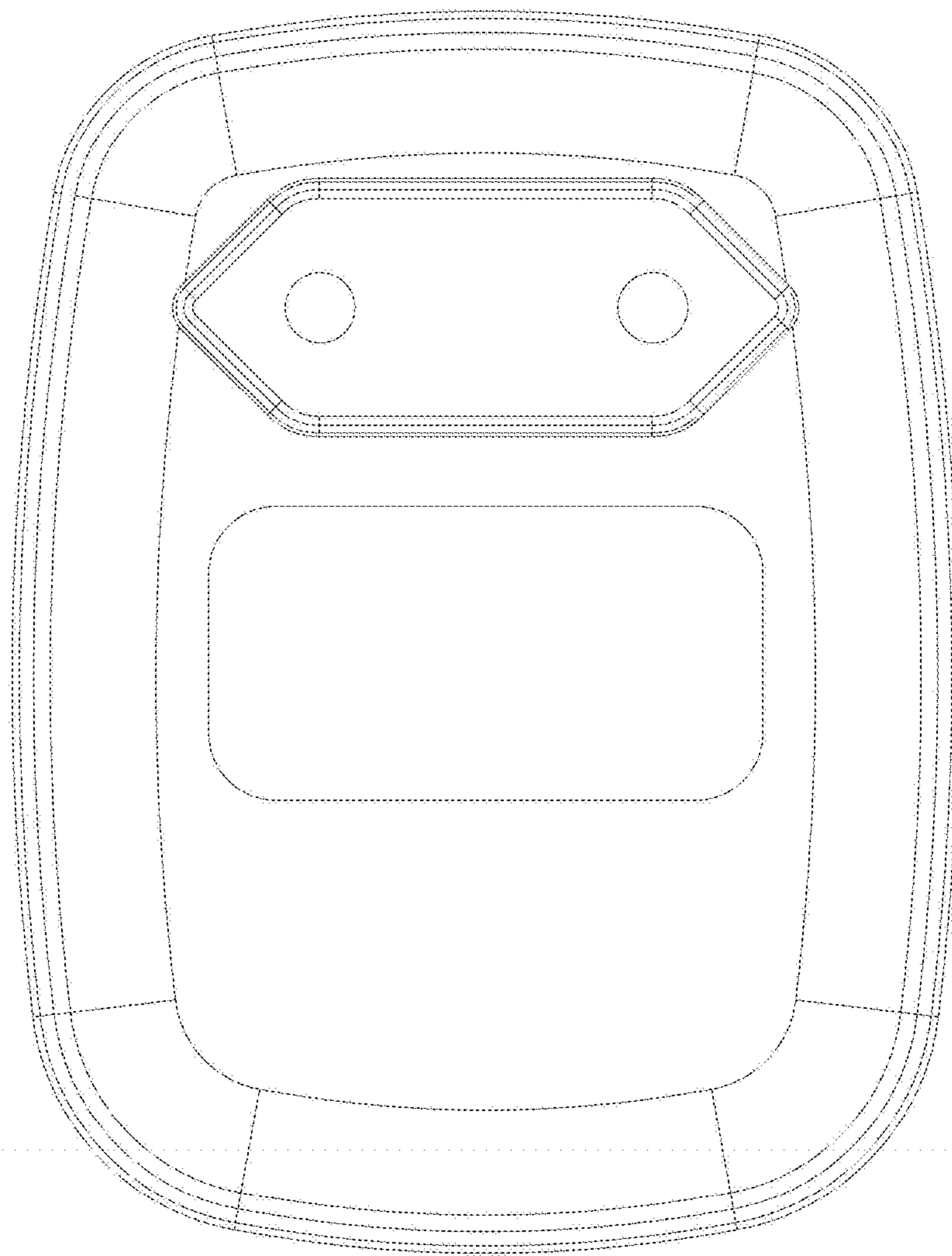

FIG. 4

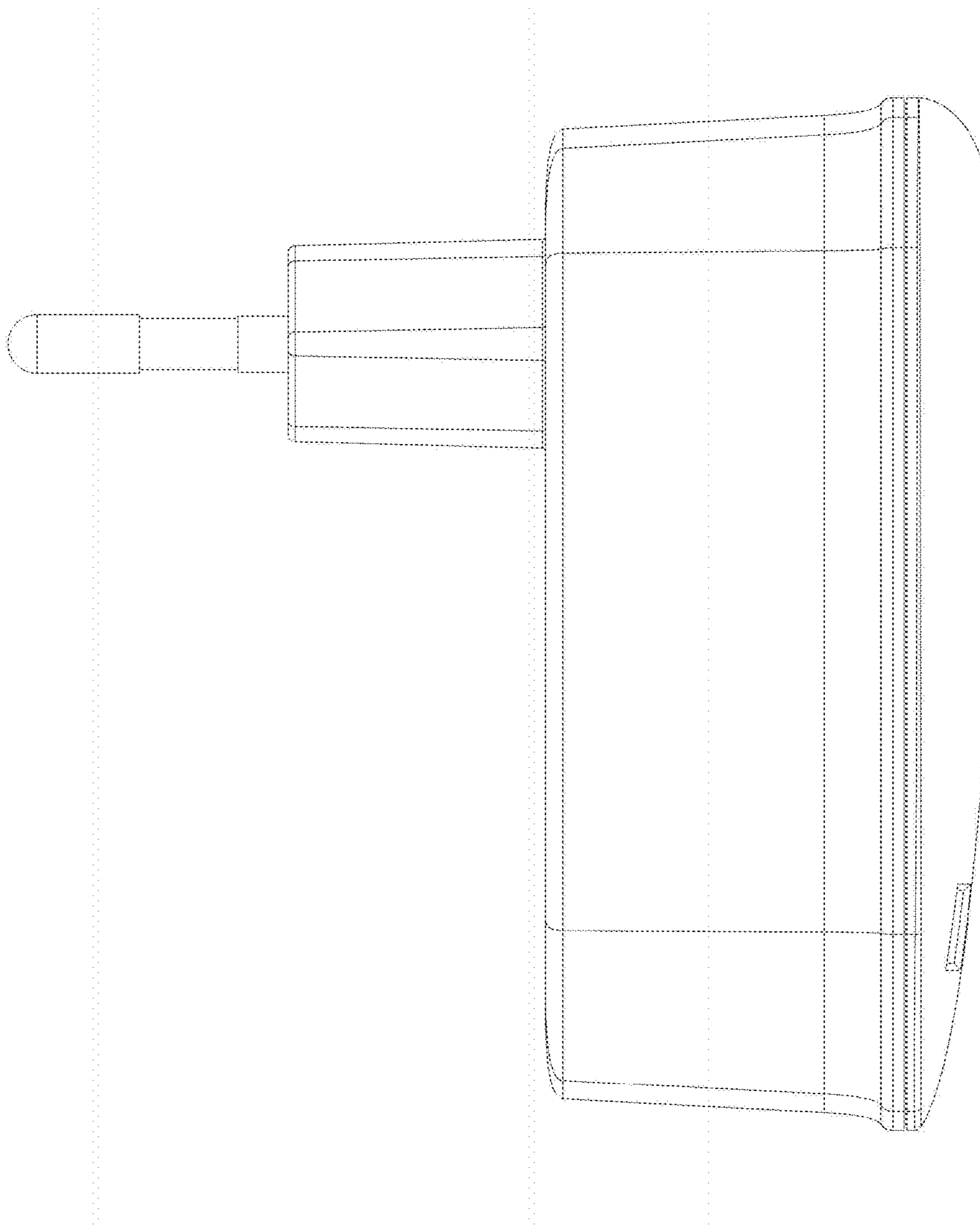

FIG. 5

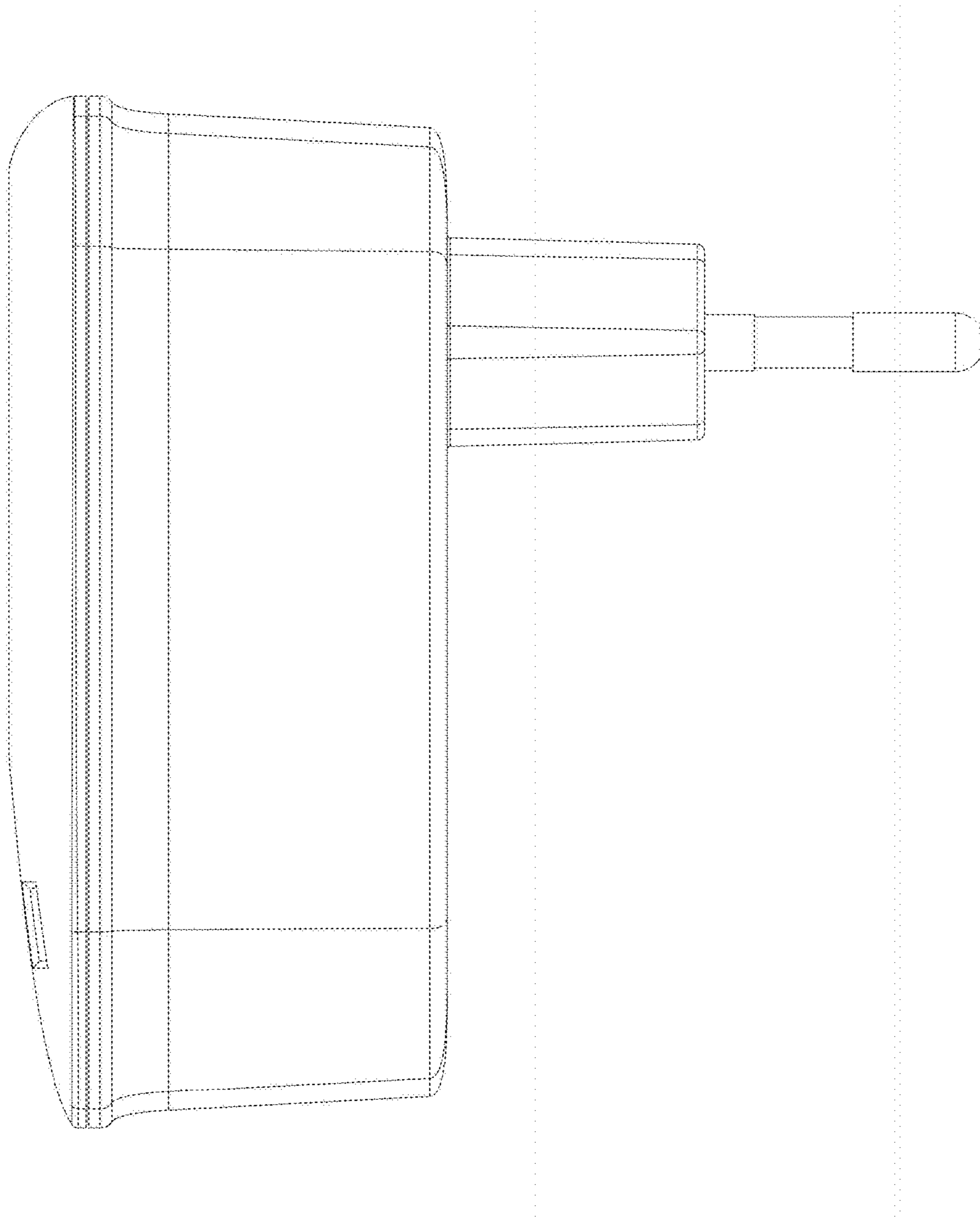

FIG. 6

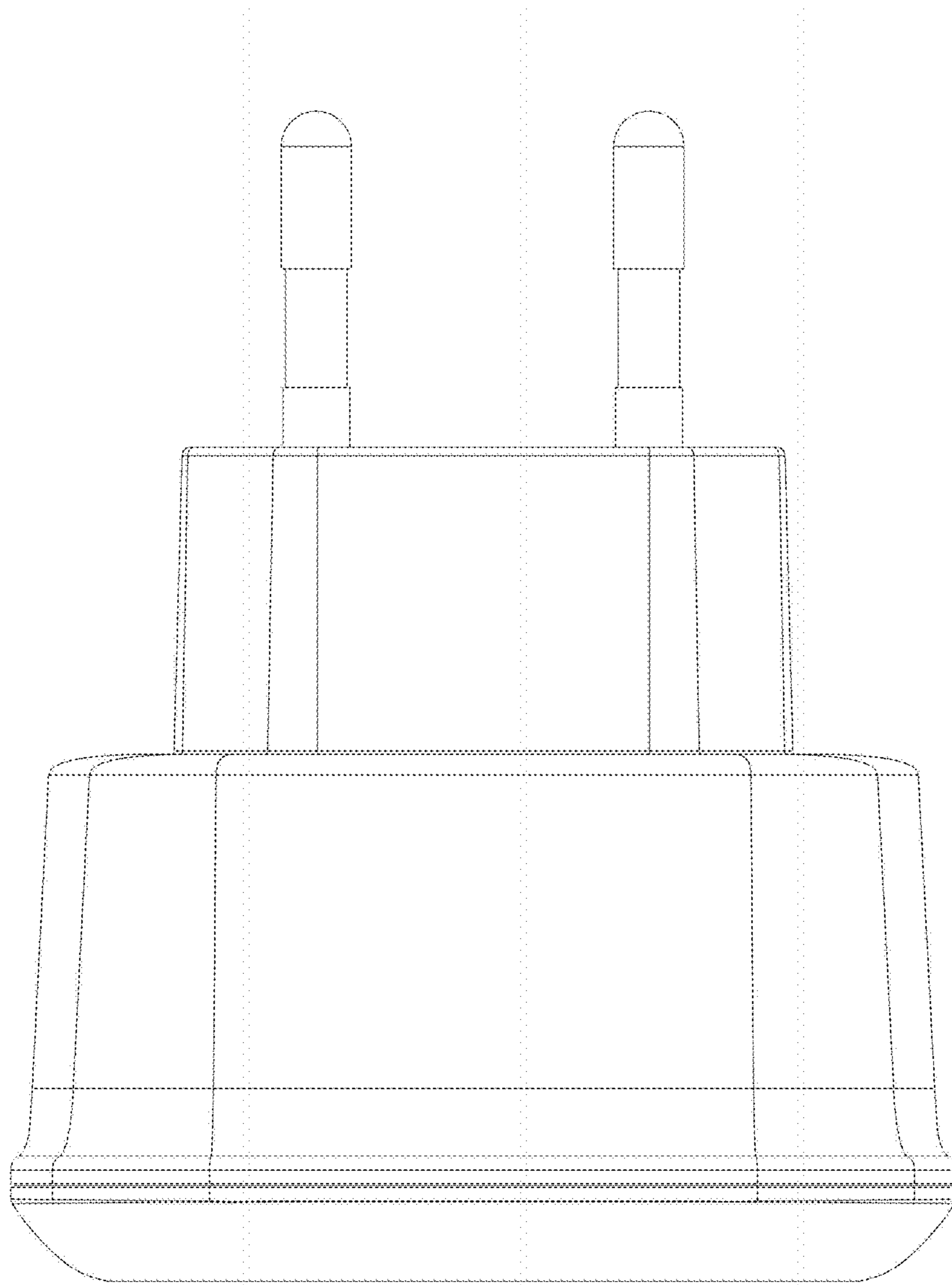

FIG. 7

