



US00D867241S

(12) **United States Design Patent** (10) **Patent No.:** **US D867,241 S**  
**Schmölz** (45) **Date of Patent:** **\*\* Nov. 19, 2019**

(54) **SPOILER FOR MOTOR VEHICLE**

D620,854 S \* 8/2010 Akasawa ..... D12/181  
D625,232 S \* 10/2010 Borkert ..... D12/181  
D656,439 S \* 3/2012 Saracoglu ..... D12/181

(71) Applicant: **Dr. Ing. h.c. F. Porsche**  
**Aktiengesellschaft, Stuttgart (DE)**

(Continued)

(72) Inventor: **Fabian Schmölz, Althengstett (DE)**

**FOREIGN PATENT DOCUMENTS**

(73) Assignee: **Dr. Ing. h.c. F. Porsche**  
**Aktiengesellschaft (DE)**

KR 19980028813 \* 8/1998 ..... B62D 35/00  
TW M252605 \* 12/2004 ..... B60R 99/00

(\*\*) Term: **15 Years**

**OTHER PUBLICATIONS**

(21) Appl. No.: **29/645,452**

Porsche Cayman GT4 Rear Wing Supports, Rennline.com, [online],  
[site visited Aug. 27, 2019]. <URL: [http://www.rennline.com/Porsche-Cayman-GT4-Rear-Wing-Supports/productinfo/SA-WR981GT4V01/?gclid=EAlalQobChM1e-JkZ2j5AIVGZsZCh19LwyZEAQYASABEgKSEPD\\_BwE](http://www.rennline.com/Porsche-Cayman-GT4-Rear-Wing-Supports/productinfo/SA-WR981GT4V01/?gclid=EAlalQobChM1e-JkZ2j5AIVGZsZCh19LwyZEAQYASABEgKSEPD_BwE)> (Year: 2019).\*

(22) Filed: **Apr. 26, 2018**

(Continued)

(30) **Foreign Application Priority Data**

Nov. 9, 2017 (DE) ..... 40 2017 101 211

(51) **LOC (12) Cl.** ..... **12-16**

(52) **U.S. Cl.**  
USPC ..... **D12/181**

(58) **Field of Classification Search**  
USPC .... D12/91, 96, 99, 400, 181, 182, 183, 184,  
D12/185, 190, 191, 192, 195, 414-426,  
D12/106, 345  
CPC .... B62D 35/02; B62D 35/005; B62D 35/007;  
B29C 65/06; B60J 1/20; B60R 7/04;  
B60R 7/18

See application file for complete search history.

*Primary Examiner* — T Chase Nelson

*Assistant Examiner* — Jonathan J. Han

(74) *Attorney, Agent, or Firm* — RatnerPrestia

(56) **References Cited**

**U.S. PATENT DOCUMENTS**

D278,046 S \* 3/1985 Kerschbaum ..... D12/181  
4,558,898 A \* 12/1985 Deaver ..... B62D 35/007  
296/180.1  
D422,544 S \* 4/2000 Carlson ..... D12/181  
D441,331 S \* 5/2001 Hatter ..... D12/181  
D465,180 S \* 11/2002 Yokomaku ..... D12/181  
D514,486 S \* 2/2006 Preuninger ..... D12/181  
D547,707 S \* 7/2007 Kulla ..... D12/181  
D549,614 S \* 8/2007 Kulla ..... D12/92  
D607,385 S \* 1/2010 Krauss ..... D12/181  
D607,386 S \* 1/2010 Kulla ..... D12/181

(57) **CLAIM**

The ornamental design for a spoiler for motor vehicle, as shown and described.

**DESCRIPTION**

FIG. 1 is a rear side perspective view of a spoiler for motor vehicle;  
FIG. 2 is a front side perspective view thereof;  
FIG. 3 is a front elevation view thereof;  
FIG. 4 is an elevation view thereof from the right side, the left side being a mirror image thereof;  
FIG. 5 is a rear elevation view thereof;  
FIG. 6 is a top plan view thereof; and,  
FIG. 7 is a bottom plan view thereof.  
The broken lines are used for the purpose of illustrating portions of the spoiler for motor vehicle that form no part of the claimed design.

**1 Claim, 4 Drawing Sheets**

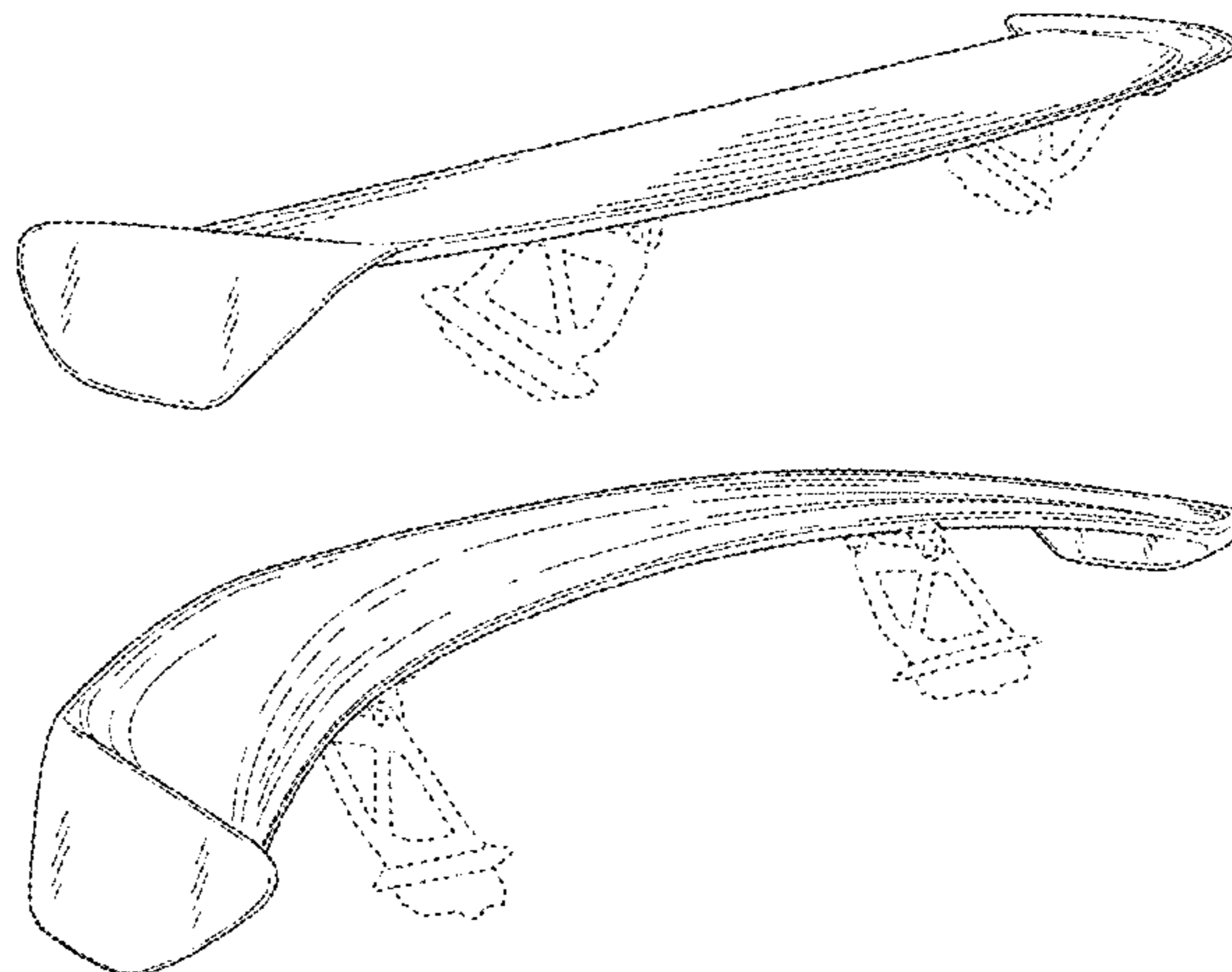

(56)

References Cited

OTHER PUBLICATIONS

U.S. PATENT DOCUMENTS

D667,763	S	9/2012	Varga	
D669,005	S	10/2012	Varga	
D683,677	S	6/2013	Varga	
D705,710	S *	5/2014	Butterworth	D12/181
D715,710	S *	10/2014	Beaven	D12/181
D716,205	S *	10/2014	Callum	D12/181
D717,221	S	11/2014	Borkert	
D722,929	S	2/2015	Hatter	
D725,559	S *	3/2015	Robinson	D12/181
D727,227	S *	4/2015	Scheinhutte	D12/181
D727,809	S *	4/2015	Scheinhutte	D12/181
D731,935	S	6/2015	Robinston	
D754,578	S *	4/2016	Buck	D12/181
D763,149	S *	8/2016	Wheel	D12/181
D763,751	S	8/2016	Varga	
D784,877	S *	4/2017	Lee	D12/181
D786,156	S *	5/2017	Kang	D12/181
D811,300	S *	2/2018	Yamashita	D12/181
D816,568	S *	5/2018	Scheinhutte	D12/181
D824,288	S *	7/2018	Hauser	D12/92
D827,524	S *	9/2018	Behmer	D12/181
D833,931	S *	11/2018	Lu	D12/181
D845,198	S *	4/2019	Beaven	D12/181
D848,325	S *	5/2019	Thurber	D12/169

Porsche Cayman GT4 981 Carbon Rear Spoiler, Carbon-Designs.com, [online], [site visited Aug. 27, 2019]. <URL: <https://carbon-designz.com/porsche-cayman-gt4-981-carbon-rear-spoiler.html>> (Year: 2019).\*

New Spoiler! (With Porsche 991 Racecar Attached), CarThrottle.com, Ollie Kew, 2012, [online], [site visited Aug. 27, 2019]. <URL: <https://www.carthrottle.com/post/new-spoiler-with-porsche-991-racecar-attached/>> (Year: 2012).\*

Design U.S. Appl. No. 29/579,465, by Scheinhütte, filed Sep. 30, 2016.

Design U.S. Appl. No. 29/590,061, by Scheinhütte, filed Jan. 6, 2017.

Design U.S. Appl. No. 29/591,933, by Varga, filed Jan. 25, 2017.

Design U.S. Appl. No. 29/592,897, by Yamashita, filed Feb. 3, 2017.

Design U.S. Appl. No. 29/613,579, Scheinhütte et al., filed Aug. 11, 2017.

Design U.S. Appl. No. 29/615,787, by Baum et al., filed Aug. 31, 2017.

Design U.S. Appl. No. 29/621,739, by Scheinhütte, filed Oct. 11, 2017.

\* cited by examiner

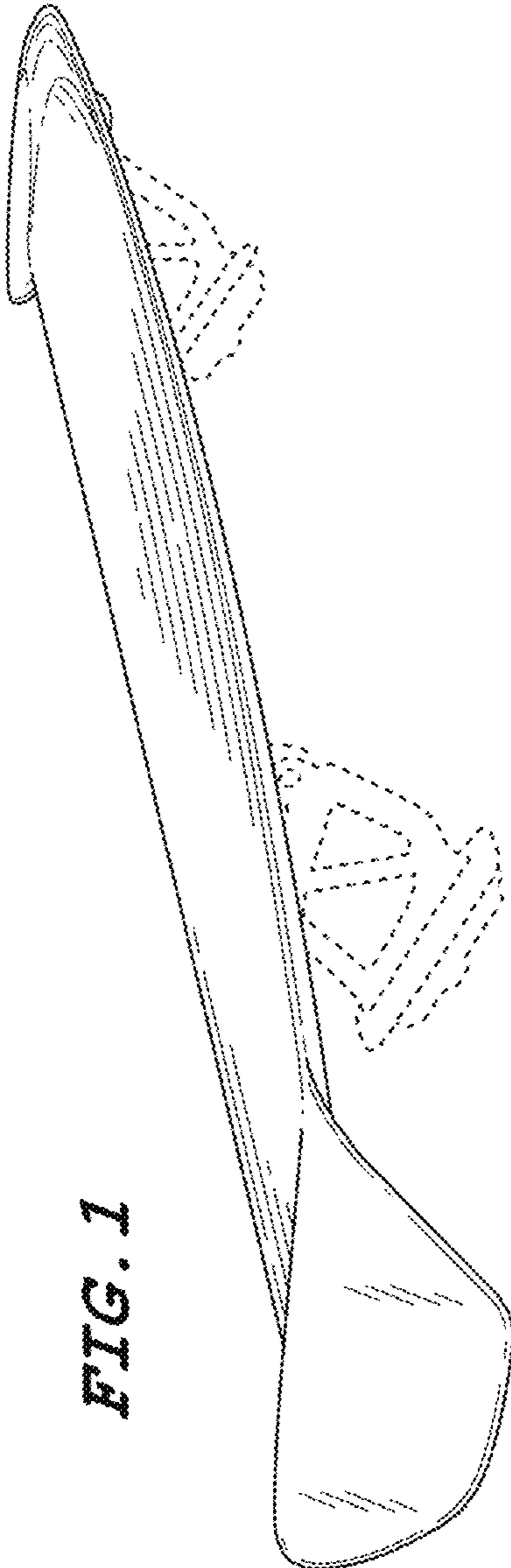
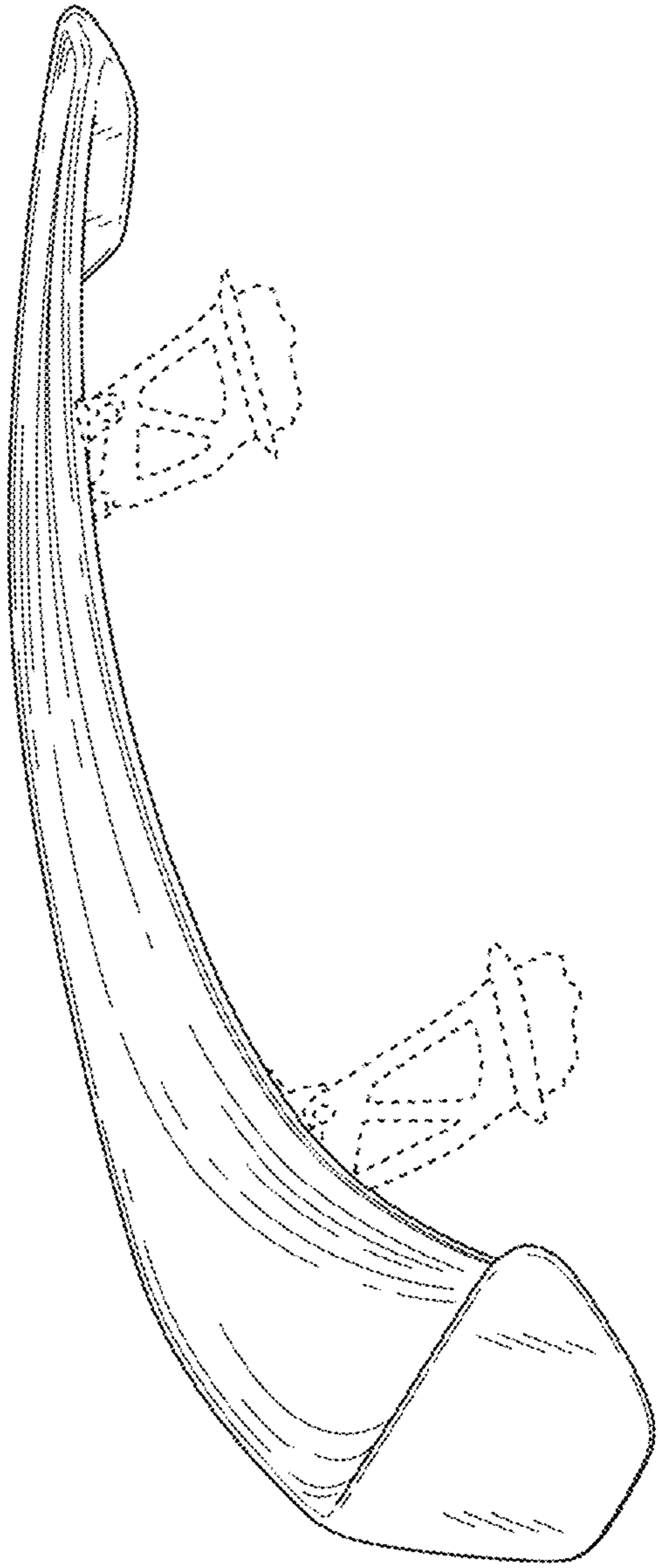
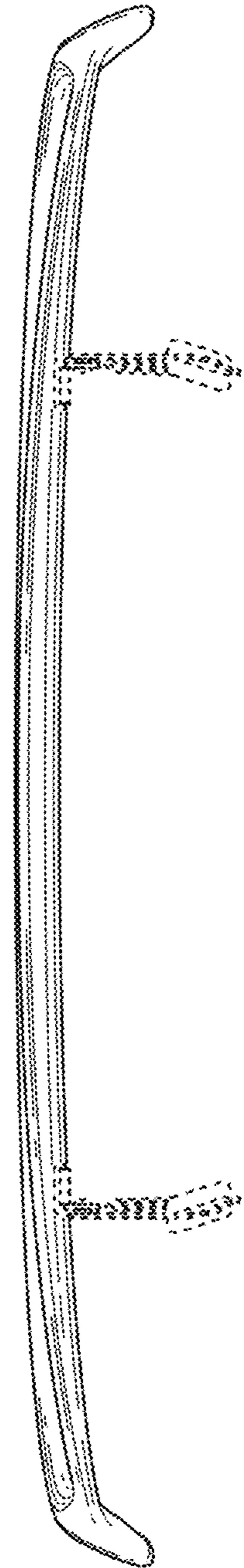

FIG. 2



**FIG. 3**



**FIG. 4**

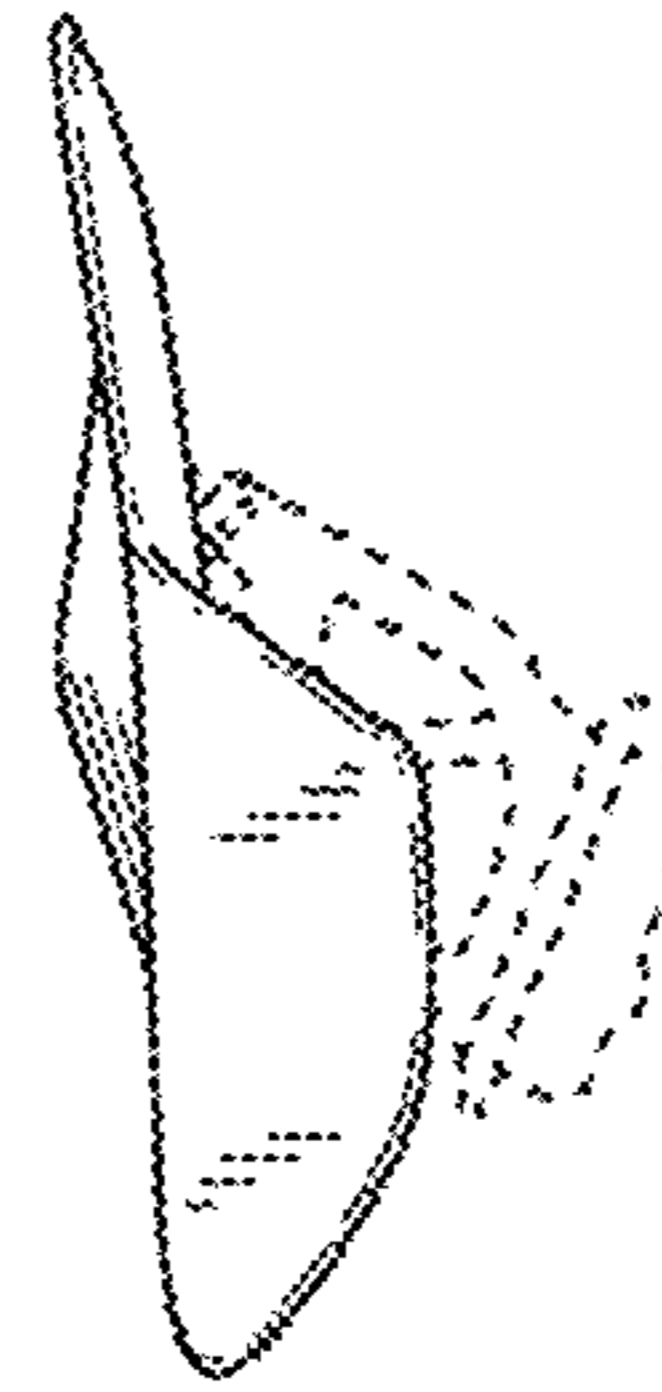

**FIG. 5**

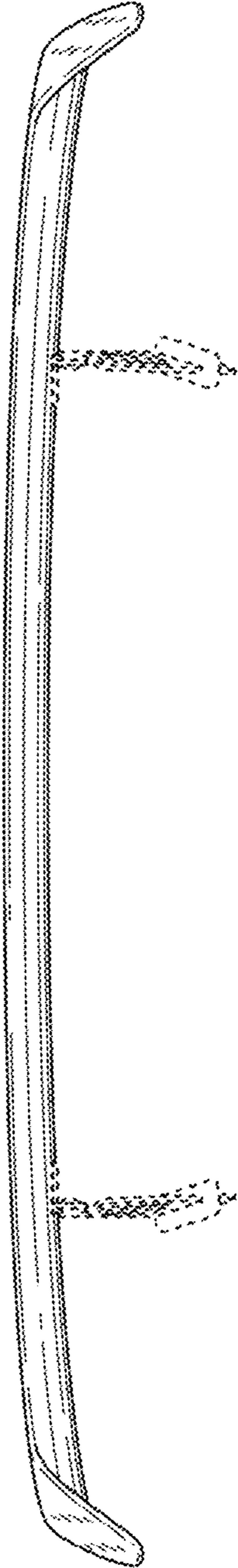

**FIG. 6**

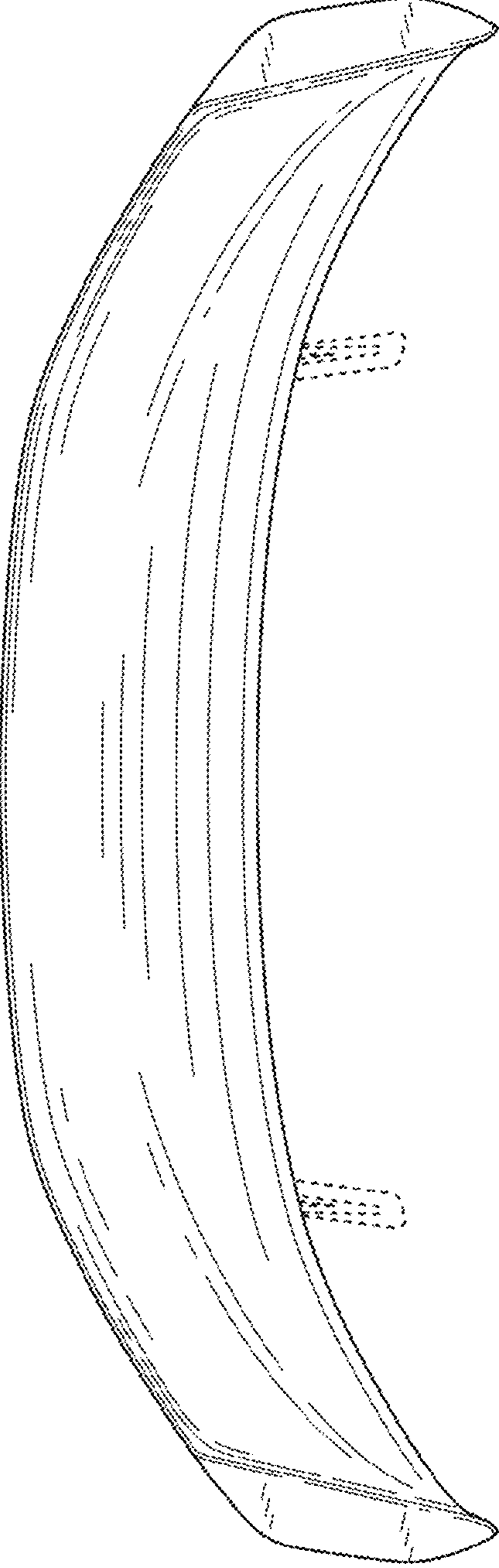

**FIG. 7**

