



US00D867211S

(12) **United States Design Patent** (10) **Patent No.:** **US D867,211 S**
Klimov et al. (45) **Date of Patent:** **** Nov. 19, 2019**

(54) **VEHICLE, TOY, AND/OR REPLICAS THEREOF**

(71) Applicant: **Bayerische Motoren Werke Aktiengesellschaft, Munich (DE)**

(72) Inventors: **Mikhail Klimov, Munich (DE); Alexander Christoph Kurt Werner, Vierkirchen (DE)**

(73) Assignee: **Bayerische Motoren Werke Aktiengesellschaft, Munich (DE)**

(**) Term: **15 Years**

(21) Appl. No.: **29/633,758**

(22) Filed: **Jan. 16, 2018**

(30) **Foreign Application Priority Data**

Jul. 25, 2017 (DE) 40 2017 100 854

(51) **LOC (12) Cl.** **12-08**

(52) **U.S. Cl.**
USPC **D12/86; D21/424**

(58) **Field of Classification Search**
USPC D12/86, 90-92; D21/424, 433, 434
CPC B62D 25/00; B62D 25/06; B62D 25/08;
B62D 33/00; B62D 5/00
See application file for complete search history.

(56) **References Cited**

U.S. PATENT DOCUMENTS

D293,697 S *	1/1988	Thornalley	D21/433
D484,439 S *	12/2003	Hanagan	D12/85
D729,121 S *	5/2015	Engler	D12/86
D730,774 S *	6/2015	Bruce	D12/86
D778,785 S *	2/2017	Hirokawa	D12/86
D787,984 S *	5/2017	Fang	D12/86
D826,779 S *	8/2018	Benedini	D12/86
D830,900 S *	10/2018	Suzuki	D12/86

FOREIGN PATENT DOCUMENTS

CN	302872910	*	7/2014
EM	001610312-0001		11/2011
EM	001144471-0001	*	12/2011
EM	001226393-0001	*	3/2013
GB	2070180	*	2/1998
WO	WO DM/025512		5/1993
WO	WO DM/058524		2/2002

OTHER PUBLICATIONS

<https://motor.ru/news/velv-26-09-2011.htm> Sep. 26, 2011 (Year: 2011).*

<https://www.dezeen.com/2017/01/06/bmw-5-series-sedan-concept-car-ces-consumer-electronics-show-2017-drone-deliveries/> Jan. 6, 2017 (Year: 2017).*

* cited by examiner

Primary Examiner — Leanne Was-Englehart

(74) *Attorney, Agent, or Firm* — Crowell & Moring LLP

(57) **CLAIM**

The ornamental design for a vehicle, toy, and/or replicas thereof, as shown and described.

DESCRIPTION

FIG. 1 is a left, front perspective view of a vehicle, toy, and/or replicas thereof according to the design;
FIG. 2 is a left side view thereof;
FIG. 3 is a right side view thereof;
FIG. 4 is a right, rear perspective view thereof;
FIG. 5 is a front view thereof;
FIG. 6 is a rear view thereof; and,
FIG. 7 is a top view thereof.

The broken lines in the drawings and the portions within in lighter gray scale are environmental subject matter only and form no part of the claimed design.

1 Claim, 7 Drawing Sheets

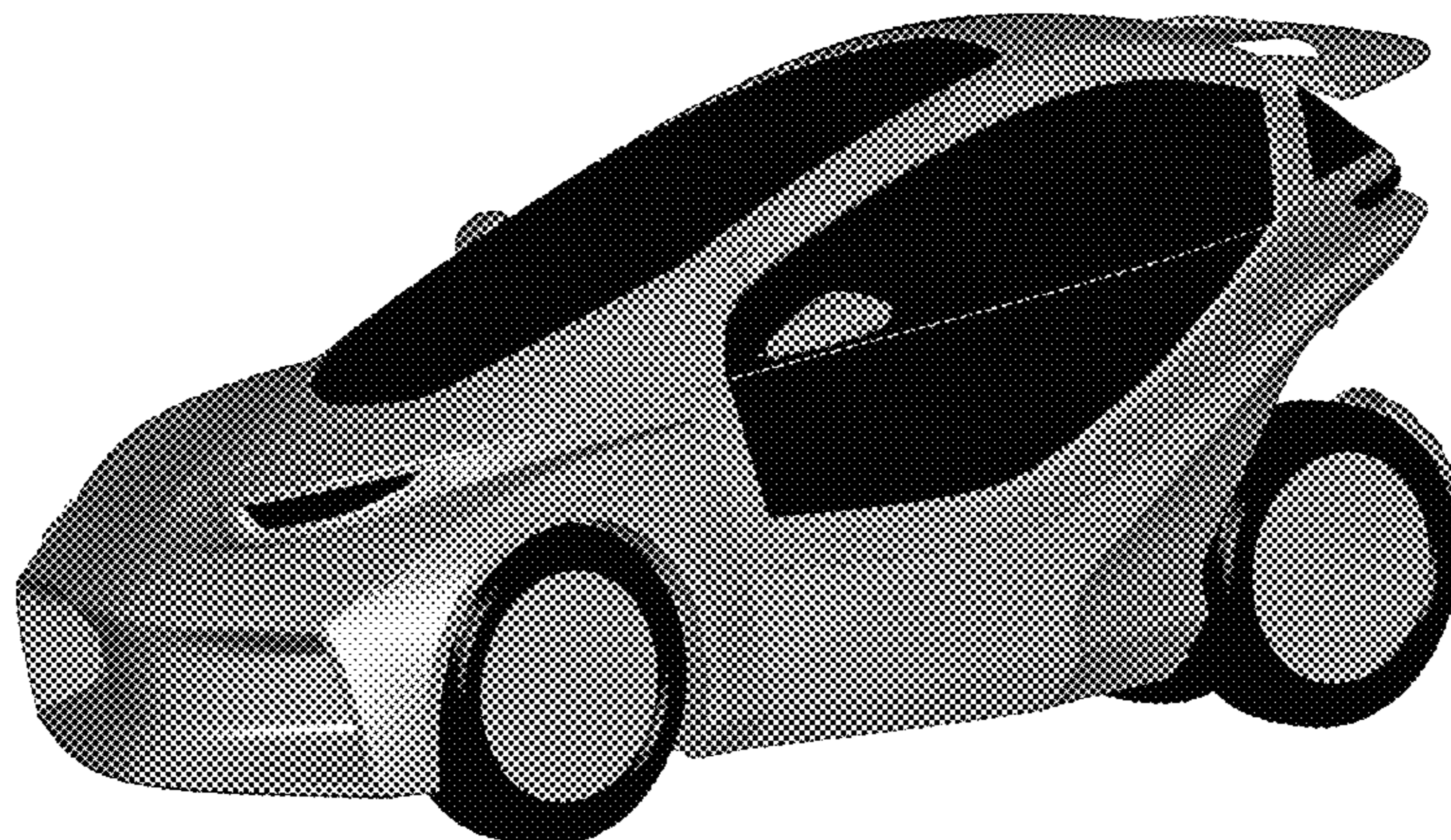



FIG. 1

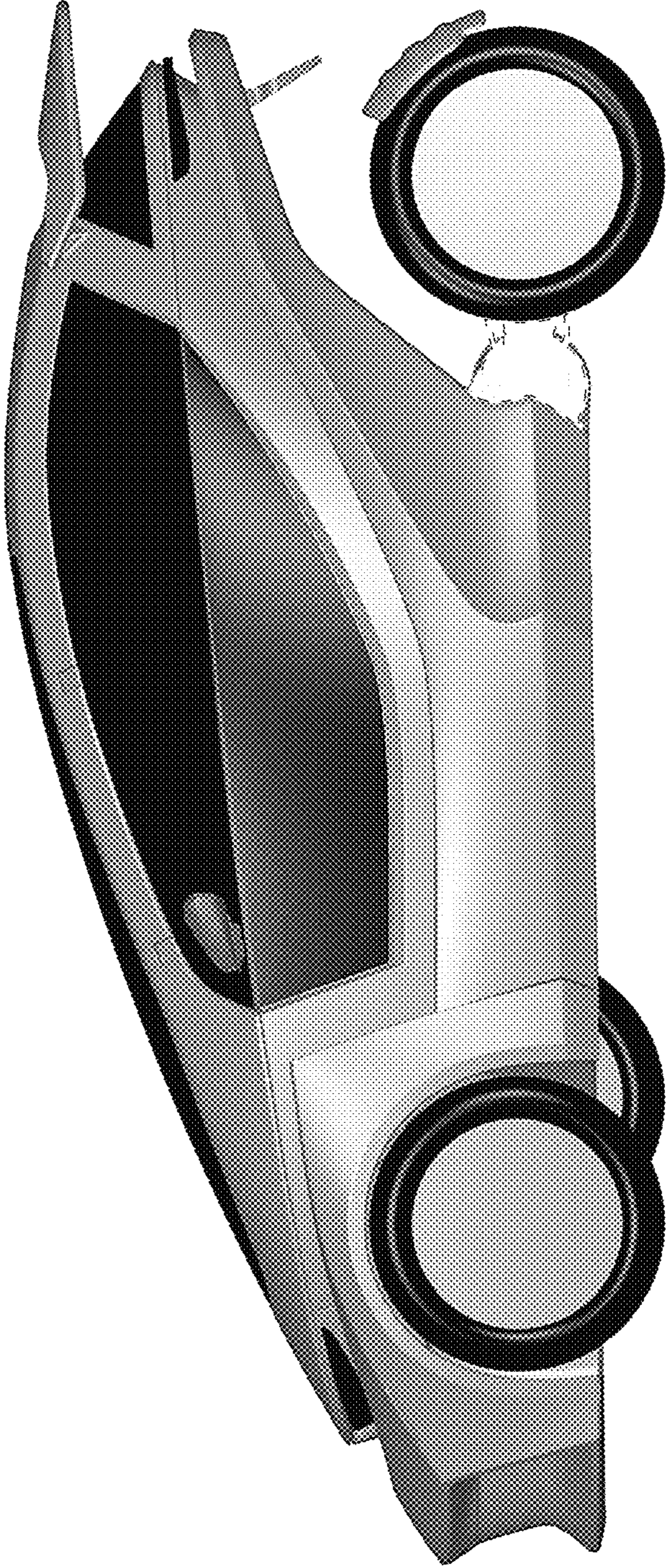

FIG. 2

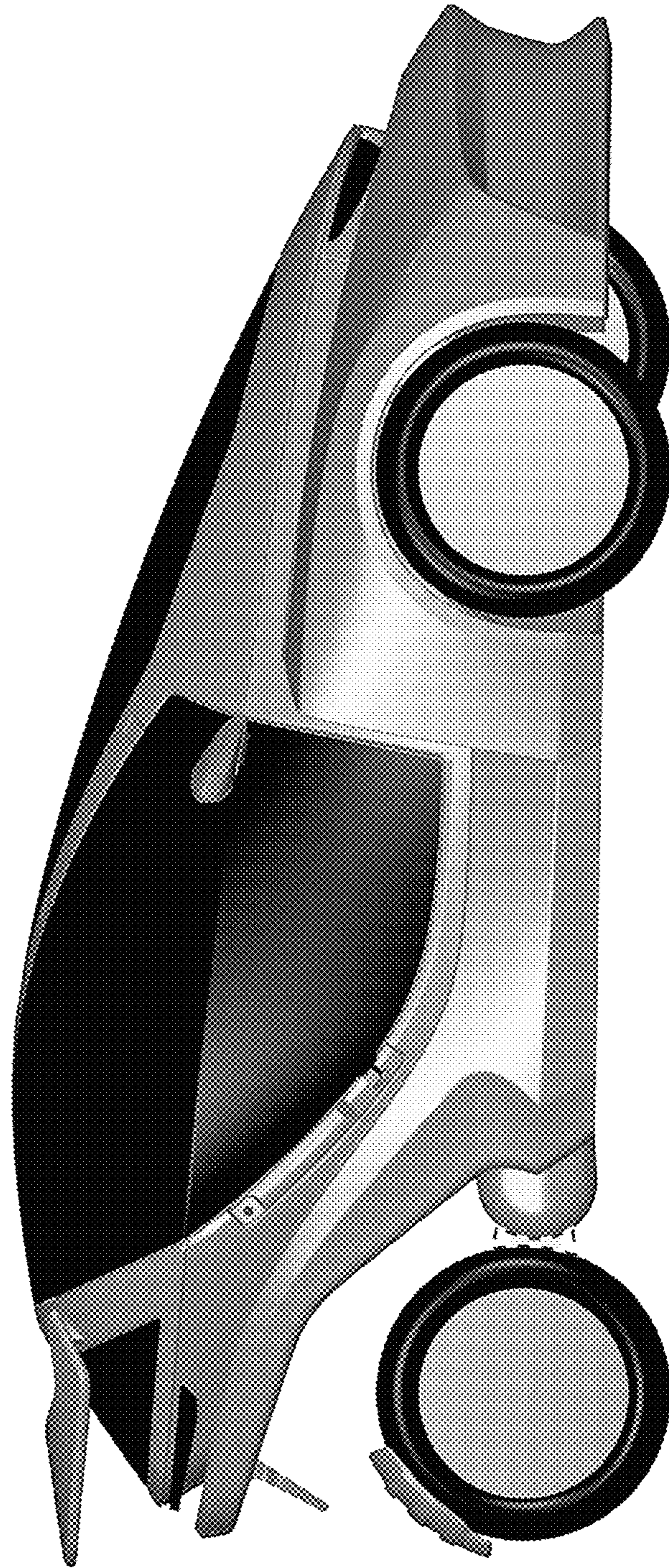

FIG. 3

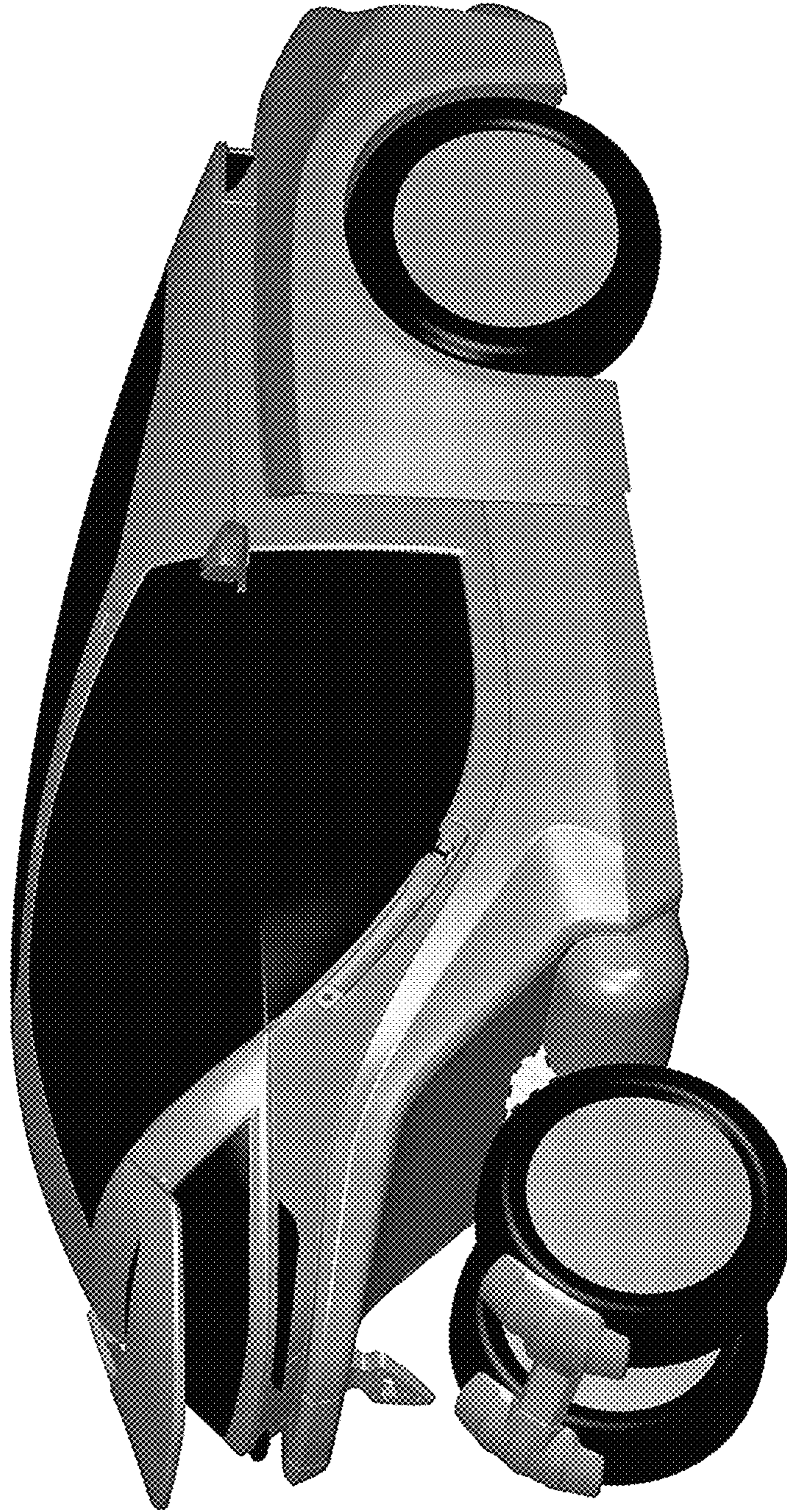

FIG. 4

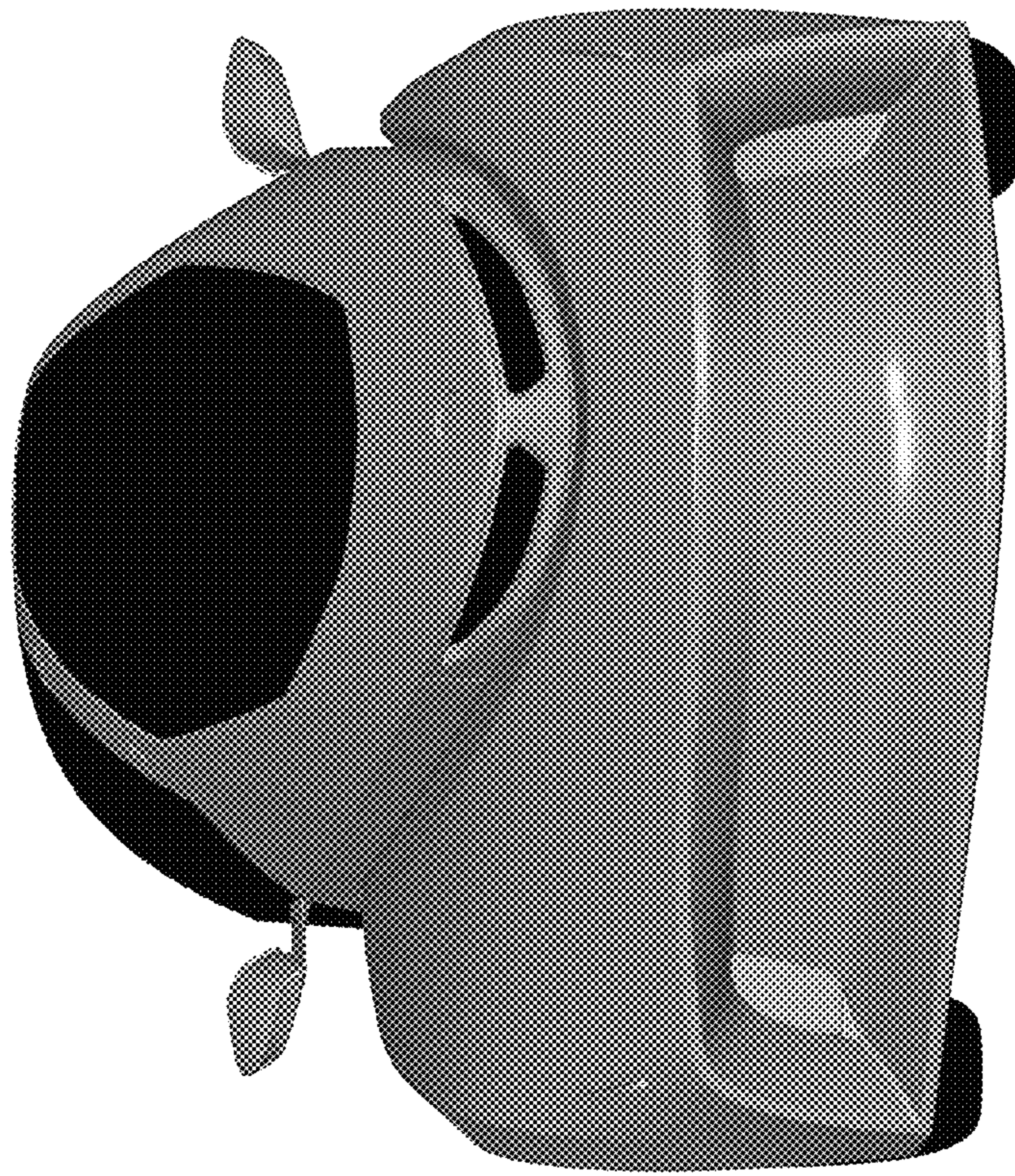

FIG. 5

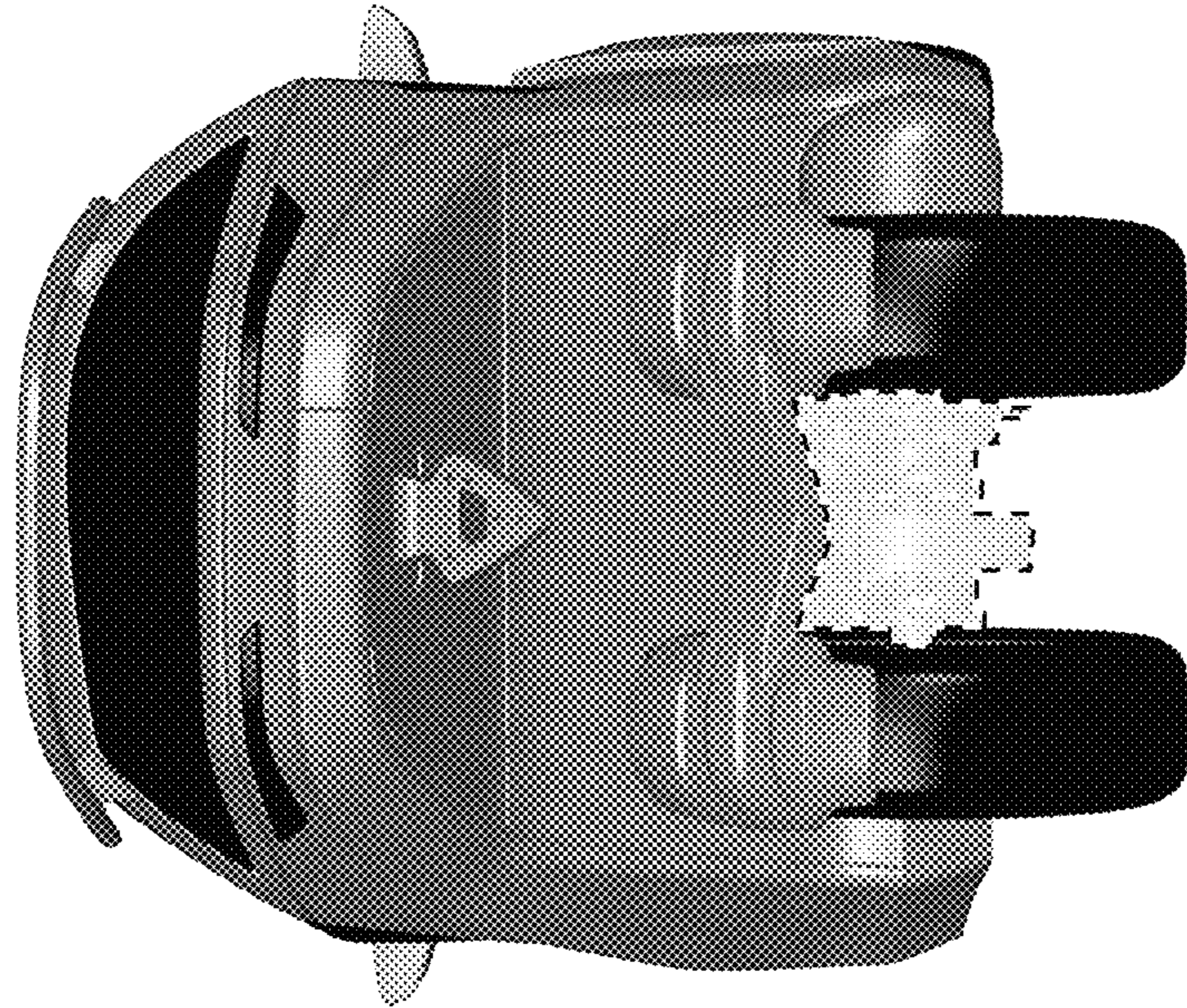

FIG. 6

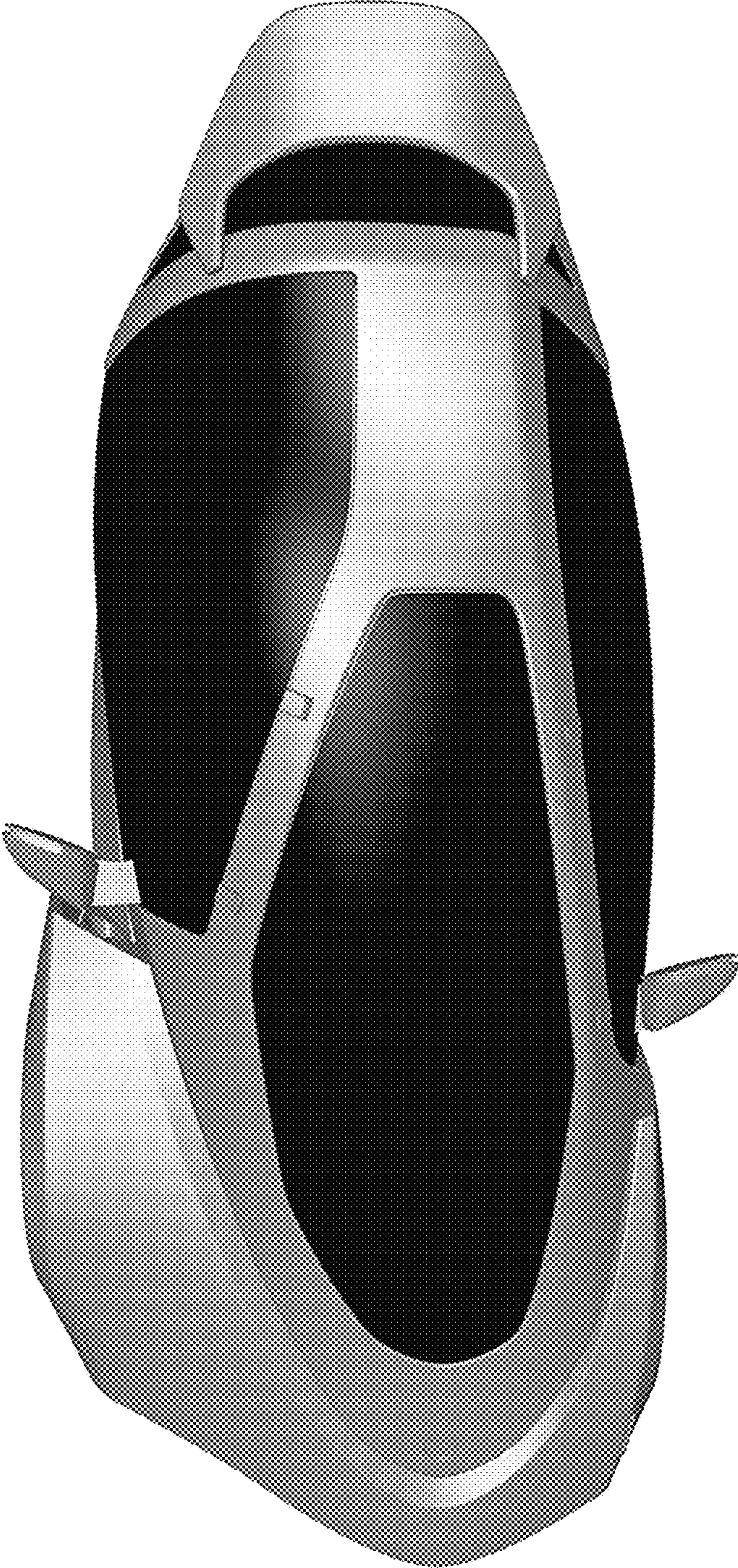

FIG. 7