



US00D867154S

(12) **United States Design Patent**
Sanghavi

(10) **Patent No.:** **US D867,154 S**

(45) **Date of Patent:** **** Nov. 19, 2019**

(54) **BOTTLE**

(71) Applicant: **Pramit Sanghavi**, New Delhi (IN)

(72) Inventor: **Pramit Sanghavi**, New Delhi (IN)

(**) Term: **15 Years**

(21) Appl. No.: **29/624,954**

(22) Filed: **Nov. 6, 2017**

(30) **Foreign Application Priority Data**

Jun. 23, 2017 (IN) 295037

(51) **LOC (12) Cl.** **09-01**

(52) **U.S. Cl.**
USPC **D9/560**; D9/574

(58) **Field of Classification Search**
USPC D9/516, 520, 522, 529-530, 541-544,
D9/559-560, 571, 574, 715, 719;
D7/509-511

CPC B65D 1/0223; B65D 1/0261; B65D 15/22;
B65D 2501/0027; B65D 2501/0081;
B65D 21/0202

See application file for complete search history.

(56) **References Cited**

U.S. PATENT DOCUMENTS

D48,734 S * 3/1916 Orem D9/546
D49,291 S * 6/1916 Vivaudou D9/546
D53,337 S * 5/1919 Leach D9/544
D93,412 S * 9/1934 Kessler D9/560
D353,100 S * 12/1994 Mandel D9/542
D489,628 S * 5/2004 Bakic D9/560

D531,046 S * 10/2006 Moretti D9/574
D545,685 S * 7/2007 Henderson D9/560
D546,701 S * 7/2007 Henderson D9/560
D550,094 S * 9/2007 Henderson D9/560
D573,893 S * 7/2008 Moretti D9/560
D586,661 S * 2/2009 Sherman D9/560
D594,343 S * 6/2009 Leruste D9/559
D615,411 S * 5/2010 Kuzma D9/522
D617,646 S * 6/2010 Kuzma D9/522
D623,532 S * 9/2010 Kuzma D9/552
D653,553 S * 2/2012 Sanghavi D9/560
D664,440 S * 7/2012 Gonzalez Rodriguez D9/544
D665,263 S * 8/2012 Sanghavi D9/522
D687,308 S * 8/2013 Lauret D9/544
D719,030 S * 12/2014 Perez-Cabrera D9/560
D719,457 S * 12/2014 Perez-Cabrera D9/560

* cited by examiner

Primary Examiner — Ian Simmons

Assistant Examiner — Keith Frank

(74) *Attorney, Agent, or Firm* — Harness, Dickey & Pierce, P.L.C.

(57) **CLAIM**

The ornamental design for a bottle, as shown and described.

DESCRIPTION

FIG. 1 is a right side view thereof;

FIG. 2 is a back view thereof;

FIG. 3 is a left side view thereof;

FIG. 4 is a front view thereof;

FIG. 5 is a top view thereof; and,

FIG. 6 is a bottom view thereof.

The broken lines in the drawings illustrate the portions of the bottle that form no part of the claimed design.

1 Claim, 5 Drawing Sheets

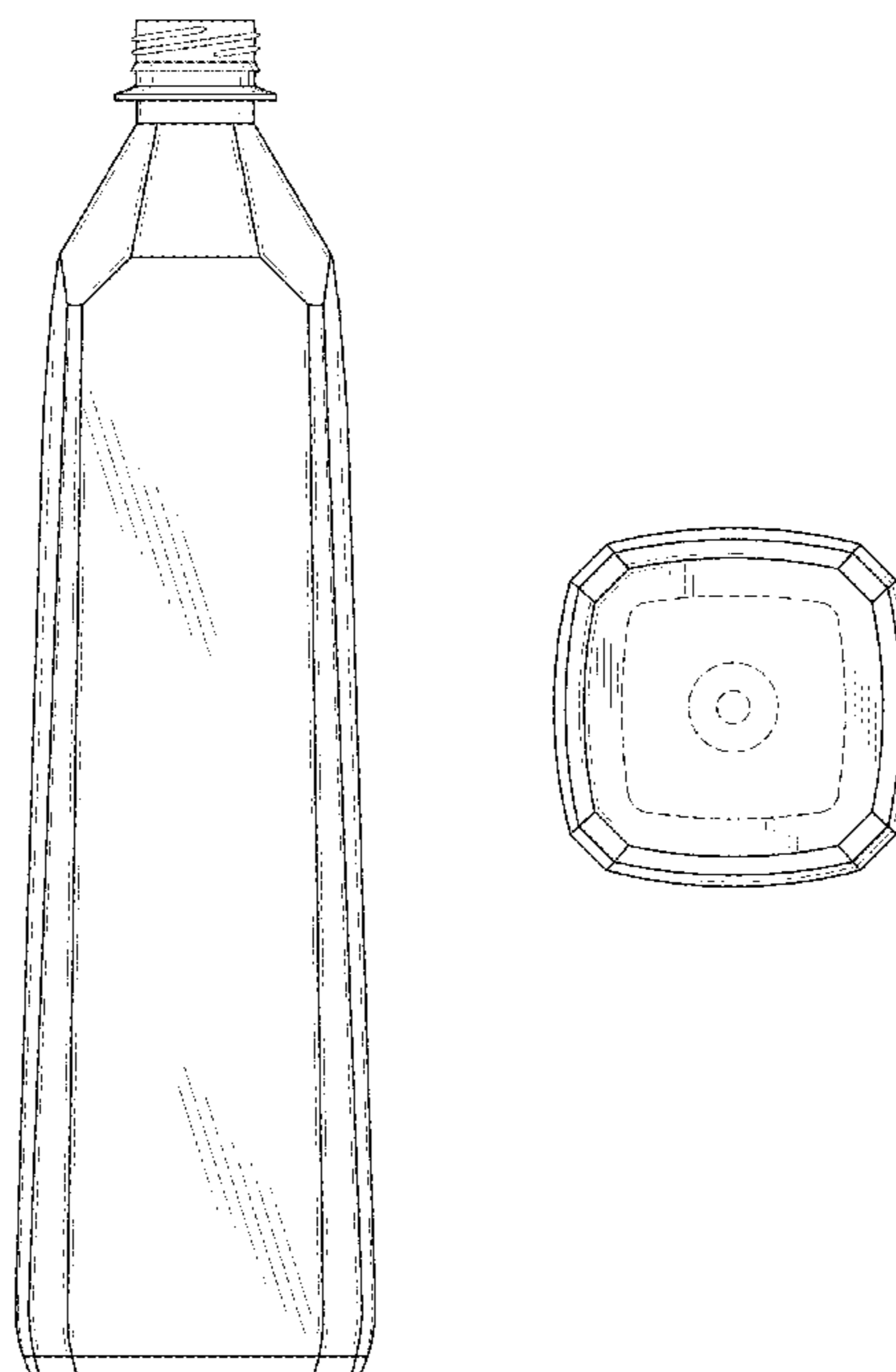

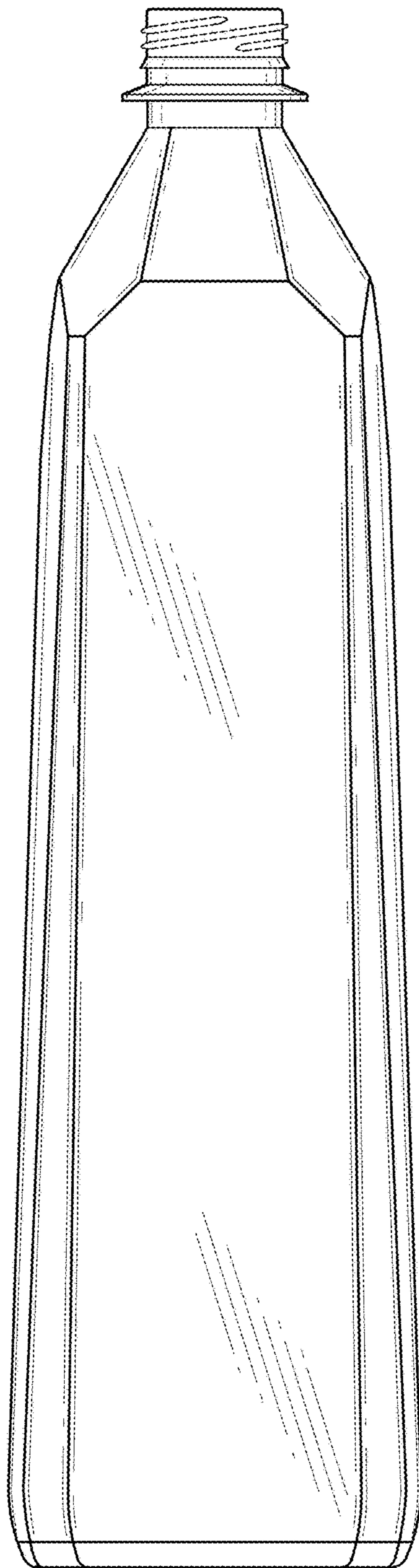

FIG. 1

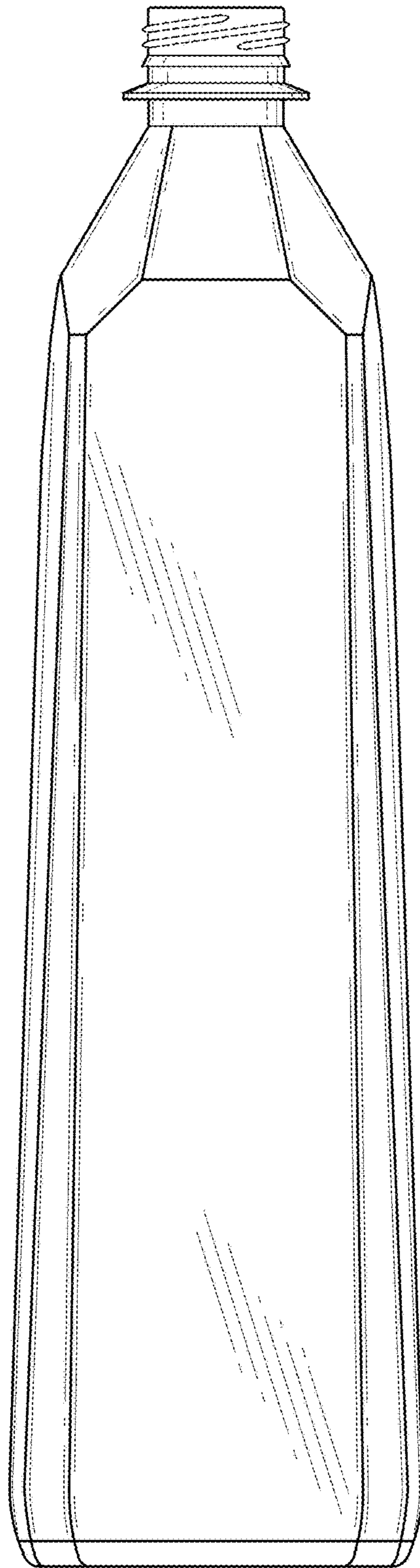

FIG. 2

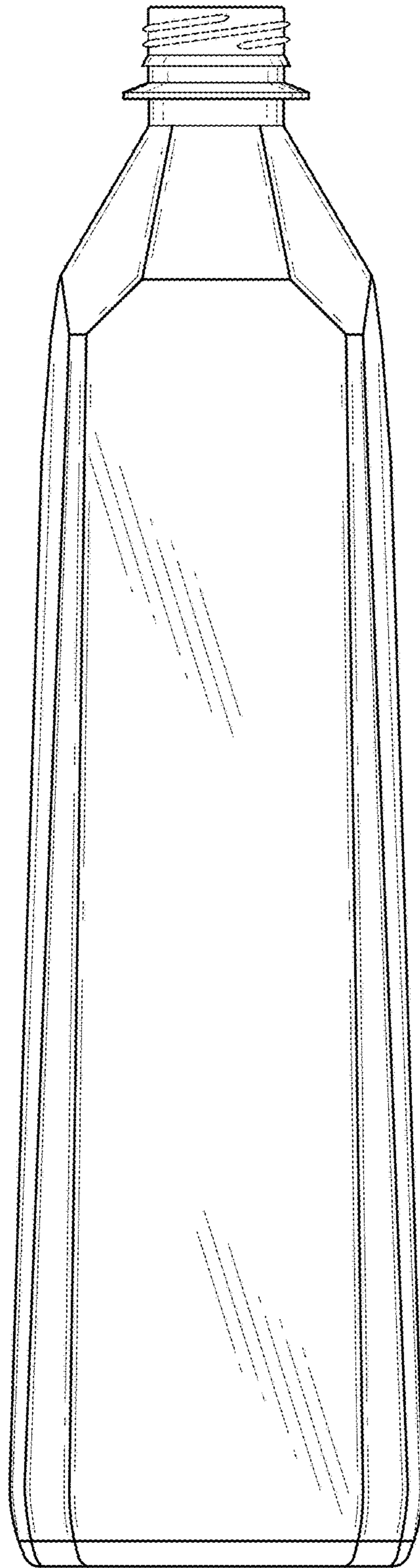

FIG. 3

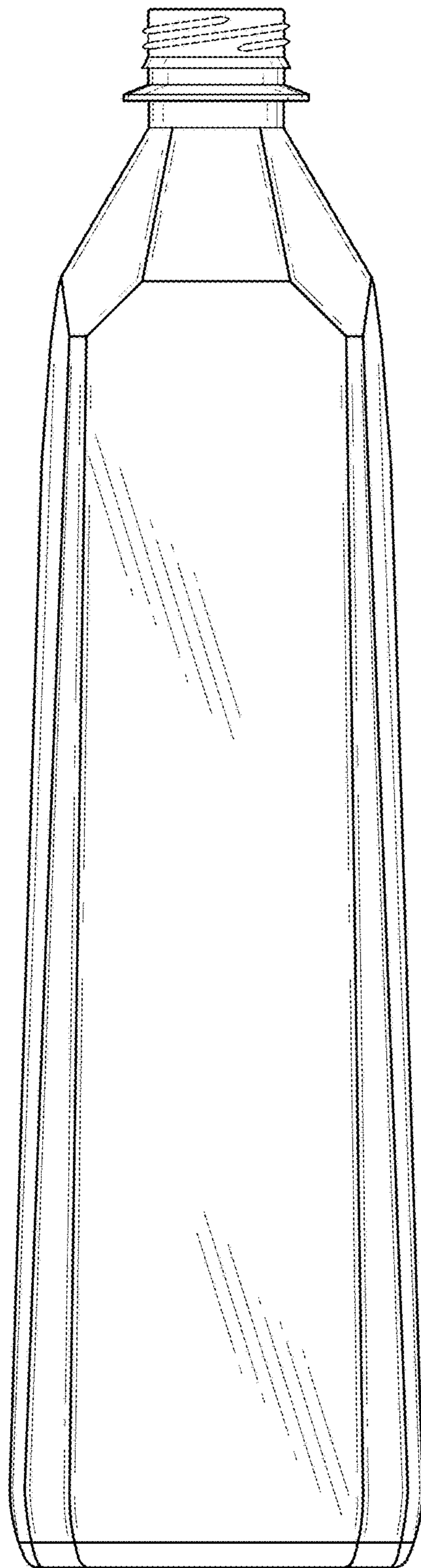

FIG. 4

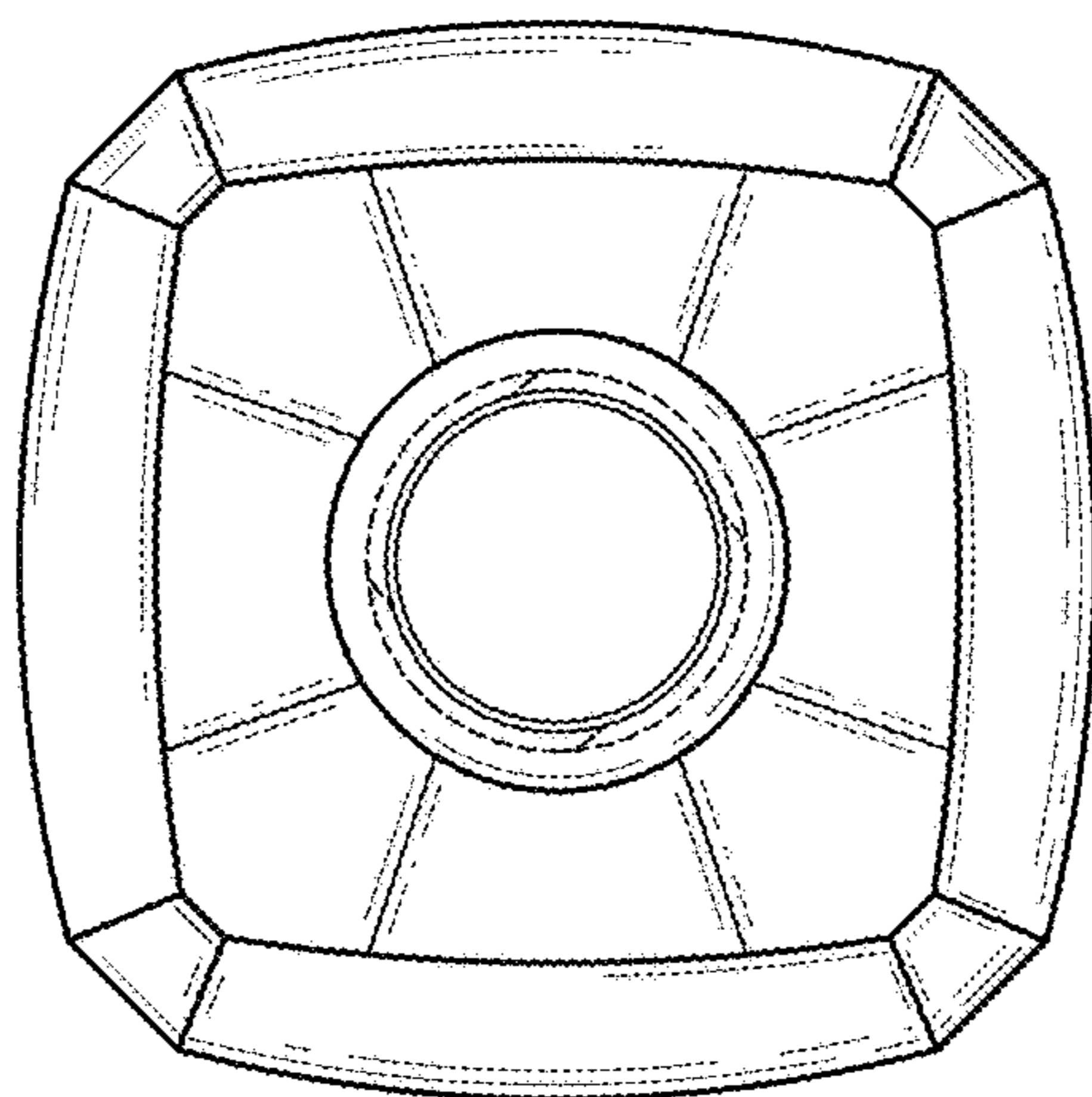

FIG. 5

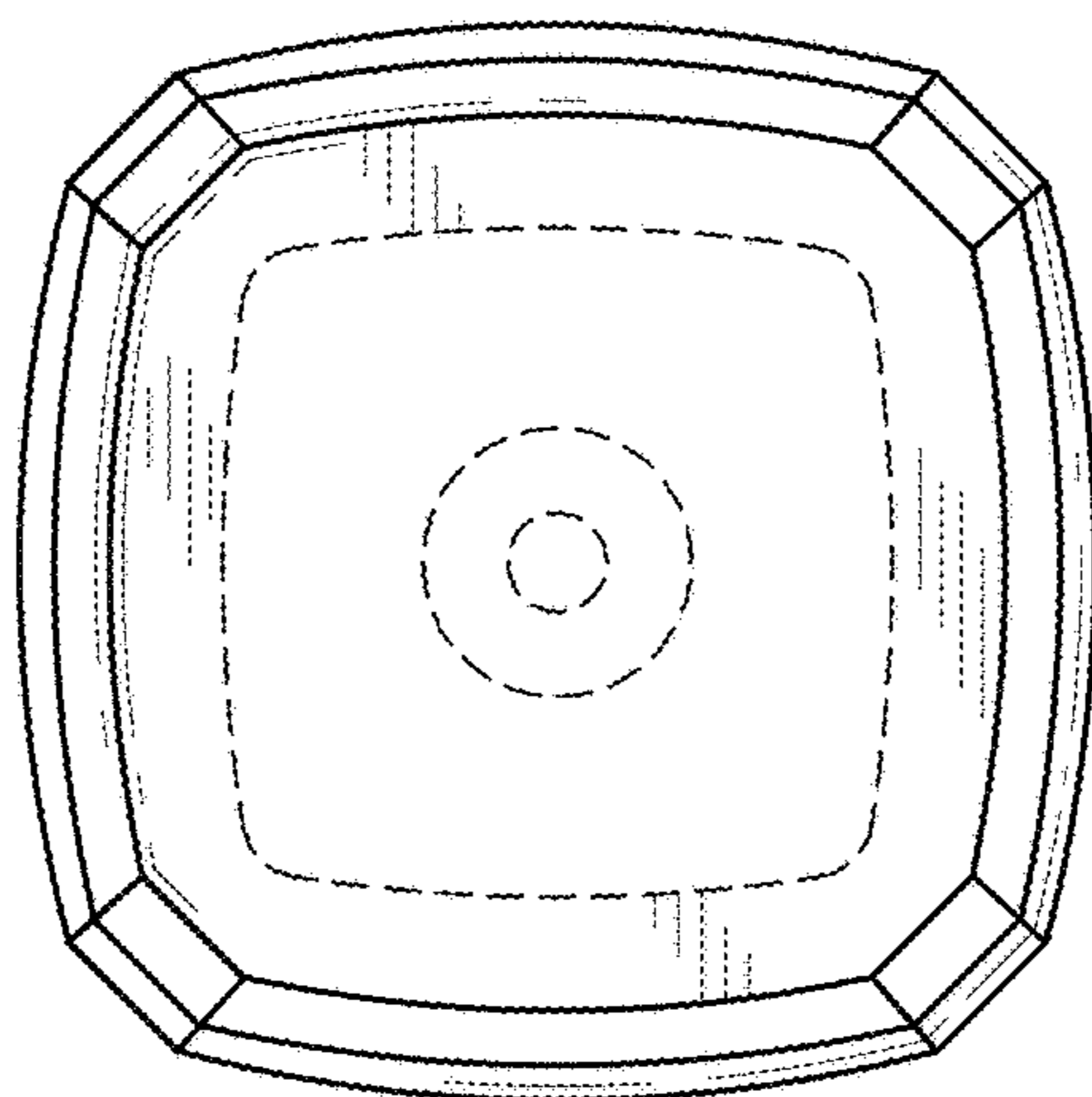

FIG. 6