



US00D867130S

(12) **United States Design Patent** (10) **Patent No.:** **US D867,130 S**  
**Merchant et al.** (45) **Date of Patent:** **\*\* Nov. 19, 2019**

(54) **OVER THE COUNTER MEDICINAL CONTAINER WITH SURFACE ORNAMENTATION**

- (71) Applicant: **The Procter & Gamble Company**, Cincinnati, OH (US)
- (72) Inventors: **Jennifer Marie Merchant**, Cincinnati, OH (US); **Jean Martin Campbell**, Cincinnati, OH (US); **Scott Cunningham**, Cincinnati, OH (US); **Kevin Wimmer**, Union Township, OH (US)
- (73) Assignee: **The Procter & Gamble Company**, Cincinnati, OH (US)
- (\*\*) Term: **15 Years**
- (21) Appl. No.: **29/600,370**
- (22) Filed: **Apr. 12, 2017**

**Related U.S. Application Data**

- (60) Continuation of application No. 29/546,445, filed on Nov. 23, 2015, now Pat. No. Des. 786,680, which is (Continued)
- (51) **LOC (12) Cl.** ..... **09-03**
- (52) **U.S. Cl.**  
USPC ..... **D9/434**
- (58) **Field of Classification Search**  
USPC ..... D9/414, 434, 457, 500, 502-505, 516, D9/549, 552, 558, 561, 571; D14/485,  
(Continued)

(56) **References Cited**

**U.S. PATENT DOCUMENTS**

- D562,692 S 2/2008 Norton et al.
  - D562,694 S 2/2008 Norton et al.
- (Continued)

**OTHER PUBLICATIONS**

All Office Actions for U.S. Appl. No. 29/104,262, filed Sep. 9, 2011.  
(Continued)

*Primary Examiner* — Dana Meyrow  
(74) *Attorney, Agent, or Firm* — Amanda Herman Berghauer

(57) **CLAIM**

The ornamental design for an over the counter medicinal container with surface ornamentation, as shown and described.

**DESCRIPTION**

The patent or application file contains at least one drawing executed in color. Copies of this patent or patent application publication with color drawing(s) will be provided by the Office upon request and payment of the necessary fee.

FIG. 1 is a perspective view of an over the counter medicinal container with surface ornamentation embodying our new design;

FIG. 2 is a front view thereof;

FIG. 3 left side view thereof;

FIG. 4 is right side view thereof;

FIG. 5 is a rear view thereof;

FIG. 6 is a top view thereof;

FIG. 7 is a bottom view thereof;

FIG. 8 is a perspective view of a second embodiment of an over the counter medicinal container with surface ornamentation embodying our new design;

FIG. 9 is a front view thereof;

FIG. 10 is a left side view thereof;

FIG. 11 is a right side view thereof;

FIG. 12 is a rear view thereof;

FIG. 13 is a top view thereof;

FIG. 14 is a bottom view thereof;

FIG. 15 is a perspective view of a third embodiment of an over the counter medicinal container with surface ornamentation embodying our new design;

FIG. 16 is a front view thereof;

FIG. 17 is a left side view thereof;

FIG. 18 is a right side view thereof;

(Continued)

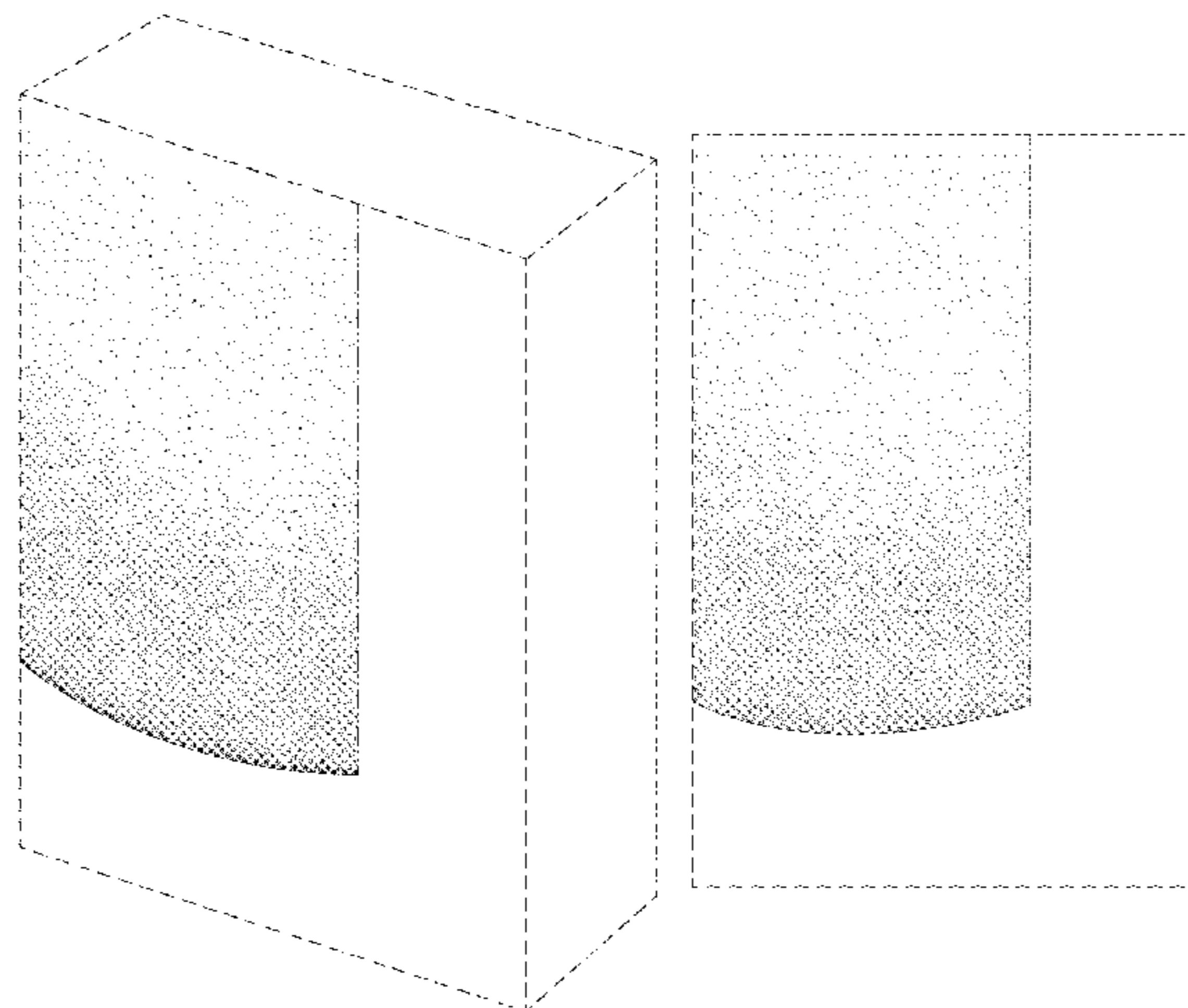

FIG. 19 is a rear view thereof;  
 FIG. 20 is a top view thereof;  
 FIG. 21 is a bottom view thereof;  
 FIG. 22 is a perspective view of a fourth embodiment of an over the counter medicinal container with surface ornamentation embodying our new design;  
 FIG. 23 is a front view thereof;  
 FIG. 24 is a left side view thereof;  
 FIG. 25 is a right side view thereof;  
 FIG. 26 is a rear view thereof;  
 FIG. 27 is a top view thereof; and,  
 FIG. 28 is a bottom view thereof.  
 The claim is directed to the area with applied surface treatment. All other portions of the over the counter medicinal container with surface ornamentation are not included in the claimed design. Broken lines in the drawings illustrate the portions of the design that form no part of the claim.

**1 Claim, 8 Drawing Sheets  
 (4 of 8 Drawing Sheet(s) Filed in Color)**

**Related U.S. Application Data**

a division of application No. 29/471,758, filed on Nov. 5, 2013, now Pat. No. Des. 747,203, which is a continuation-in-part of application No. 29/401,262, filed on Sep. 9, 2011, now Pat. No. Des. 703,533.

(58) **Field of Classification Search**

USPC ..... D14/488-489; D20/11, 22, 27, 42; 215/379, 381-382; 220/660, 669, 675  
 CPC ..... B65D 1/00; B65D 1/02; B65D 1/0223; B65D 1/40; B65D 23/00; B65D 23/12; B65D 23/14; B65D 2203/00; B65D 2203/02; B65D 2501/0009

See application file for complete search history.

(56) **References Cited**

U.S. PATENT DOCUMENTS

D566,577 S 4/2008 Norton et al.  
 D587,111 S 2/2009 Seol et al.  
 D589,359 S 3/2009 Kusumi  
 D590,250 S 4/2009 Seol

D590,251 S 4/2009 Seol et al.  
 D590,252 S 4/2009 Seol et al.  
 D590,253 S 4/2009 Seol et al.  
 D599,201 S 9/2009 Seol et al.  
 D600,548 S 9/2009 Seol et al.  
 D603,701 S 11/2009 Seol et al.  
 D608,636 S 1/2010 Seol  
 D611,832 S 3/2010 Champion et al.  
 D618,556 S 6/2010 Partin et al.  
 D622,610 S 8/2010 Powers et al.  
 D622,611 S 8/2010 Powers et al.  
 D622,774 S 8/2010 Seum et al.  
 D625,193 S 10/2010 Partin et al.  
 D626,010 S 10/2010 Criss et al.  
 D634,620 S 3/2011 Edwards  
 D634,621 S 3/2011 Edwards  
 D638,703 S 5/2011 Sovonick et al.  
 D647,796 S 11/2011 Sovonick et al.  
 D647,797 S 11/2011 Sovonick et al.  
 D648,218 S 11/2011 Powers et al.  
 D649,044 S 11/2011 Sovonick et al.  
 D649,877 S 12/2011 Sovonick et al.  
 D654,370 S 2/2012 Campbell et al.  
 D668,672 S 10/2012 Chaudhri  
 D677,580 S 3/2013 Powers et al.  
 D680,753 S 4/2013 Thompson et al.  
 D680,862 S 4/2013 Thompson et al.  
 D680,864 S 4/2013 Thompson et al.  
 D680,865 S 4/2013 Thompson et al.  
 D683,216 S 5/2013 Thompson et al.  
 D683,218 S 5/2013 Thompson et al.  
 D701,760 S 4/2014 Fraser et al.  
 D703,041 S 4/2014 Abel et al.  
 D703,532 S 4/2014 Merchant et al.  
 D703,533 S 4/2014 Merchant et al.  
 D706,630 S 6/2014 Merchant et al.  
 D707,122 S 6/2014 Merchant et al.  
 D711,737 S 8/2014 Hara et al.  
 D744,334 S \* 12/2015 Merchant ..... D9/434  
 D747,196 S \* 1/2016 Merchant ..... D9/434  
 D747,203 S 1/2016 Merchant et al.  
 D786,680 S 5/2017 Merchant et al.  
 D842,696 S \* 3/2019 Haen ..... D9/434  
 D846,386 S \* 4/2019 Borkovetz ..... D9/434

OTHER PUBLICATIONS

All Office Actions for U.S. Appl. No. 29/471,758, filed Nov. 5, 2013.  
 All Office Actions for U.S. Appl. No. 29/546,445, filed Nov. 23, 2015.

\* cited by examiner

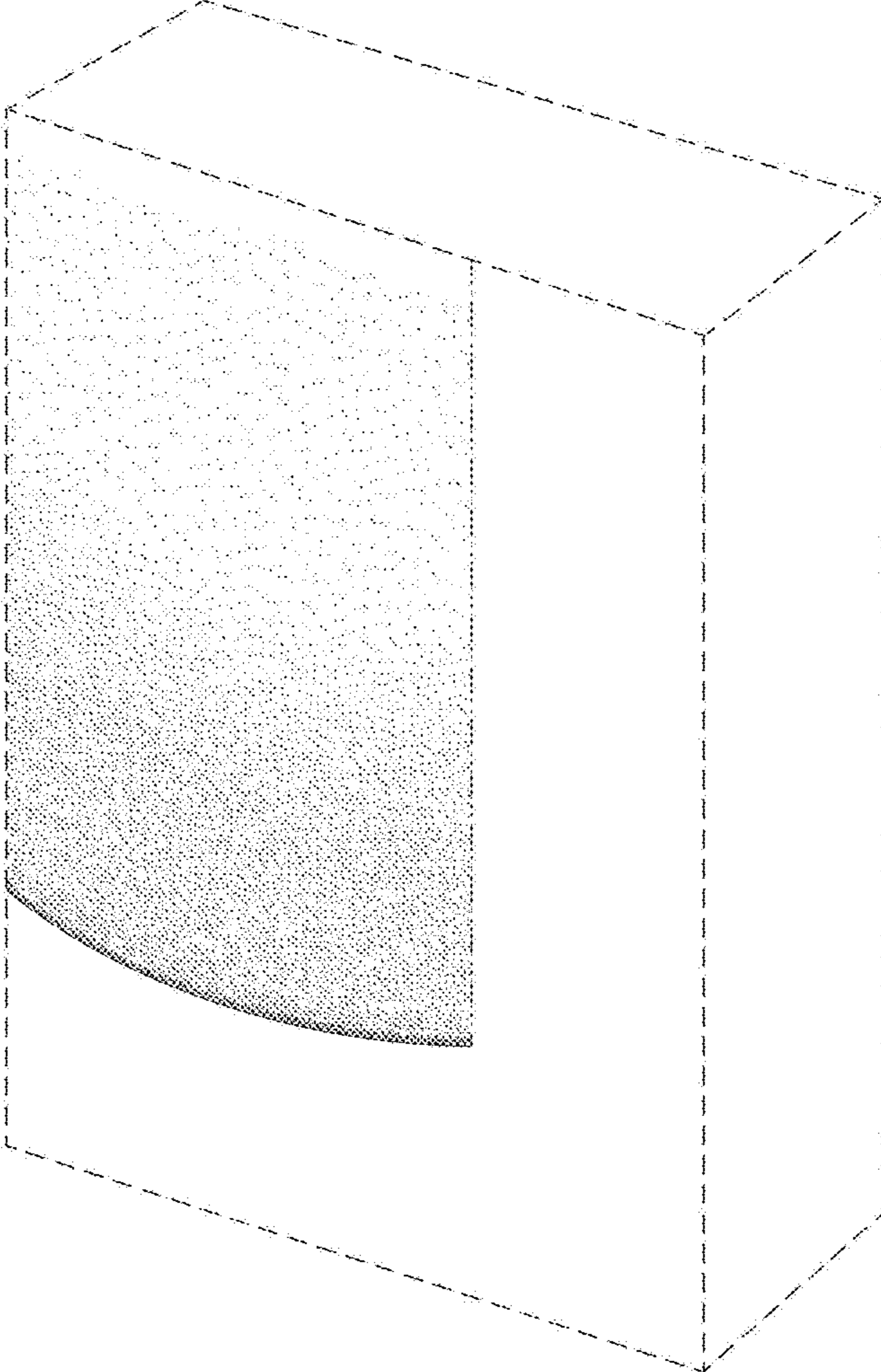

Fig. 1

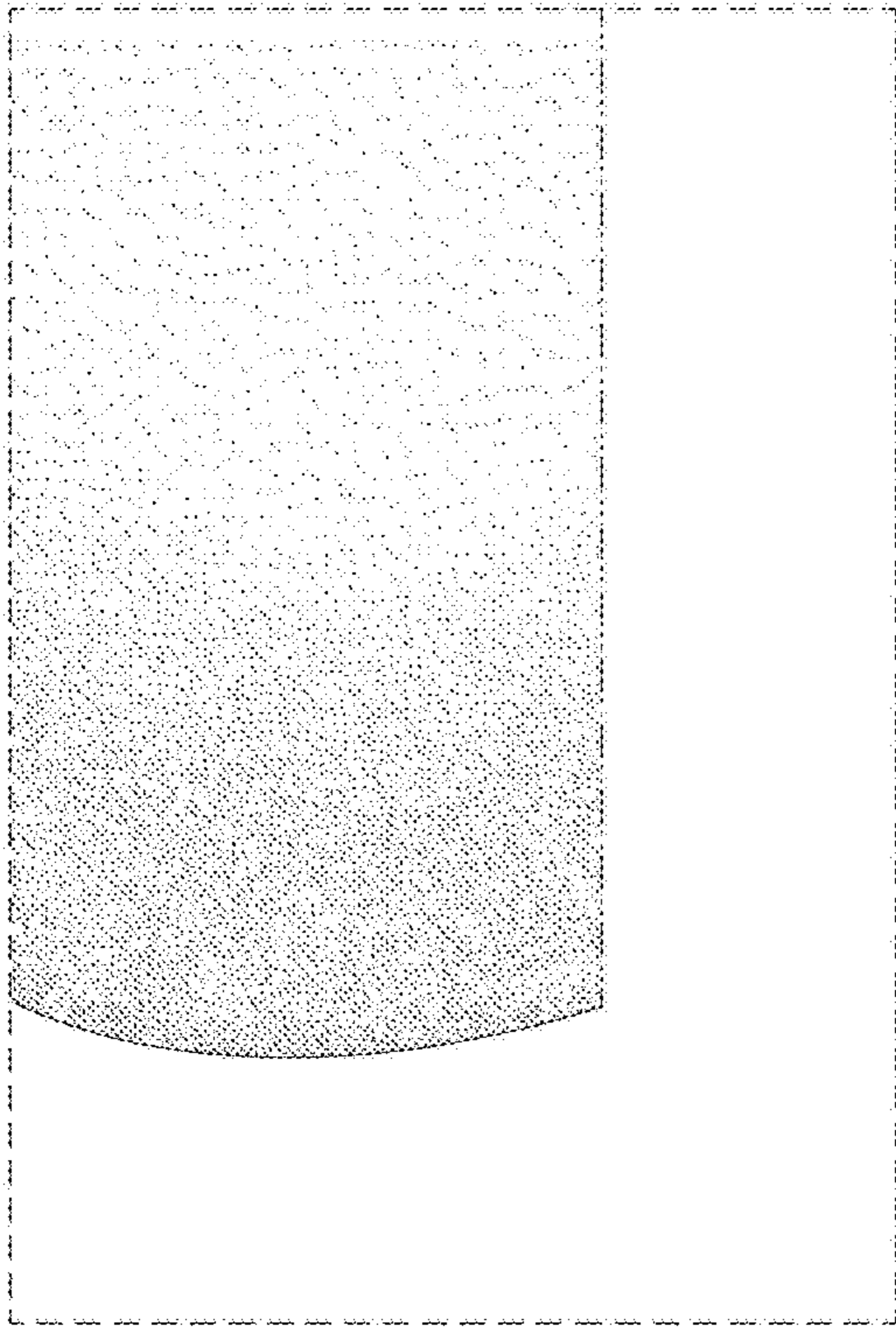

Fig. 2

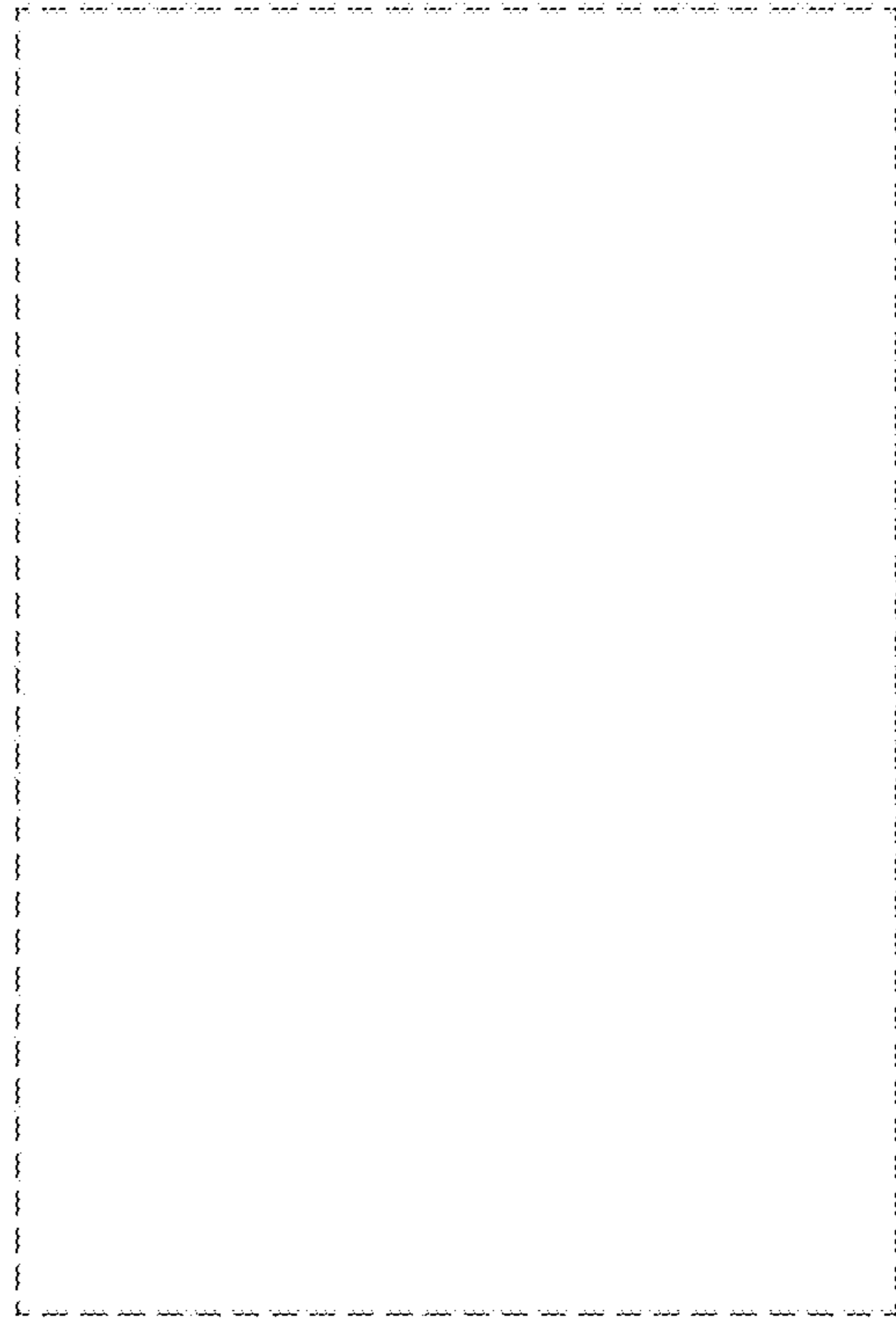

Fig. 5

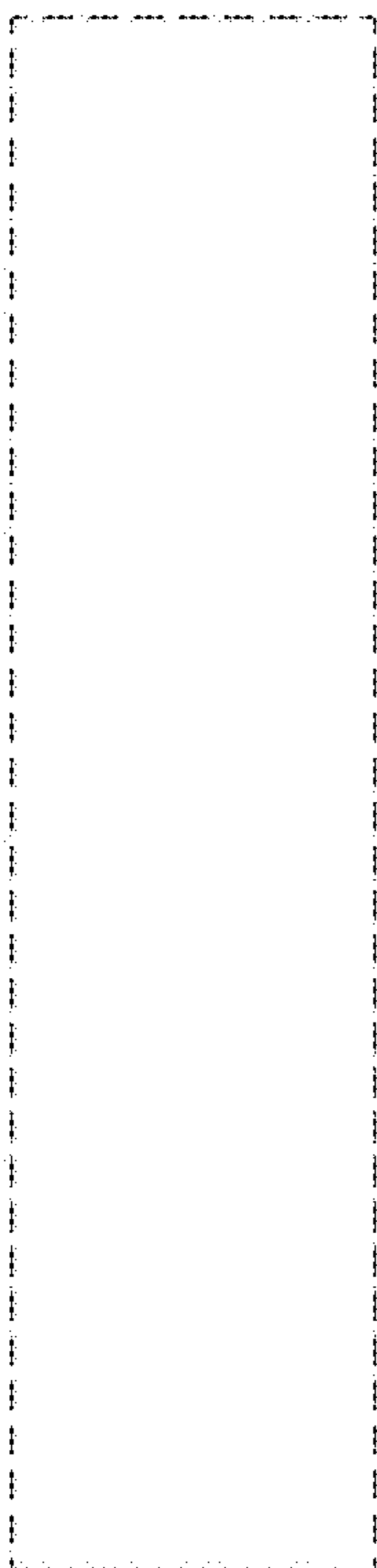

Fig. 3

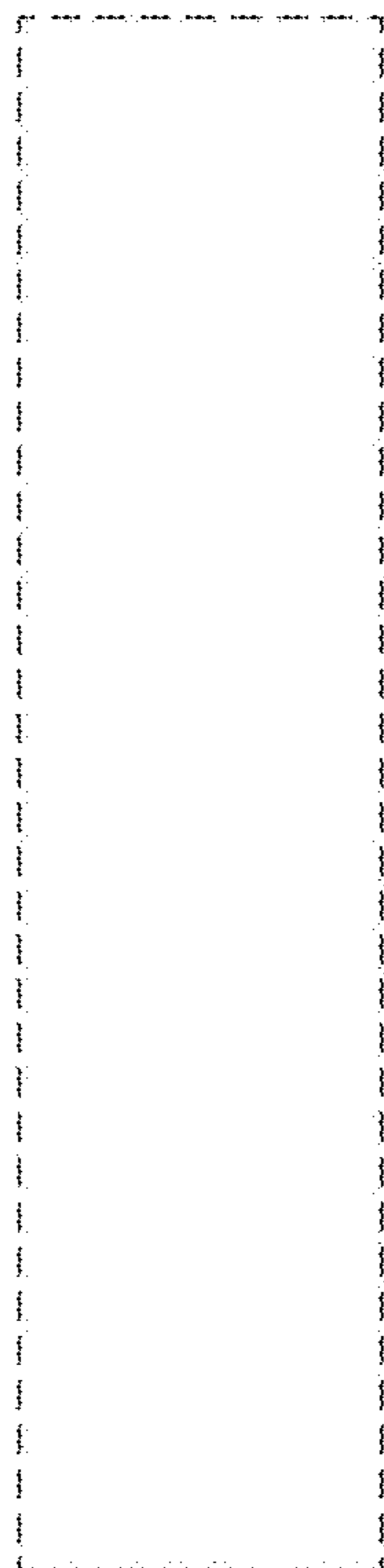

Fig. 4

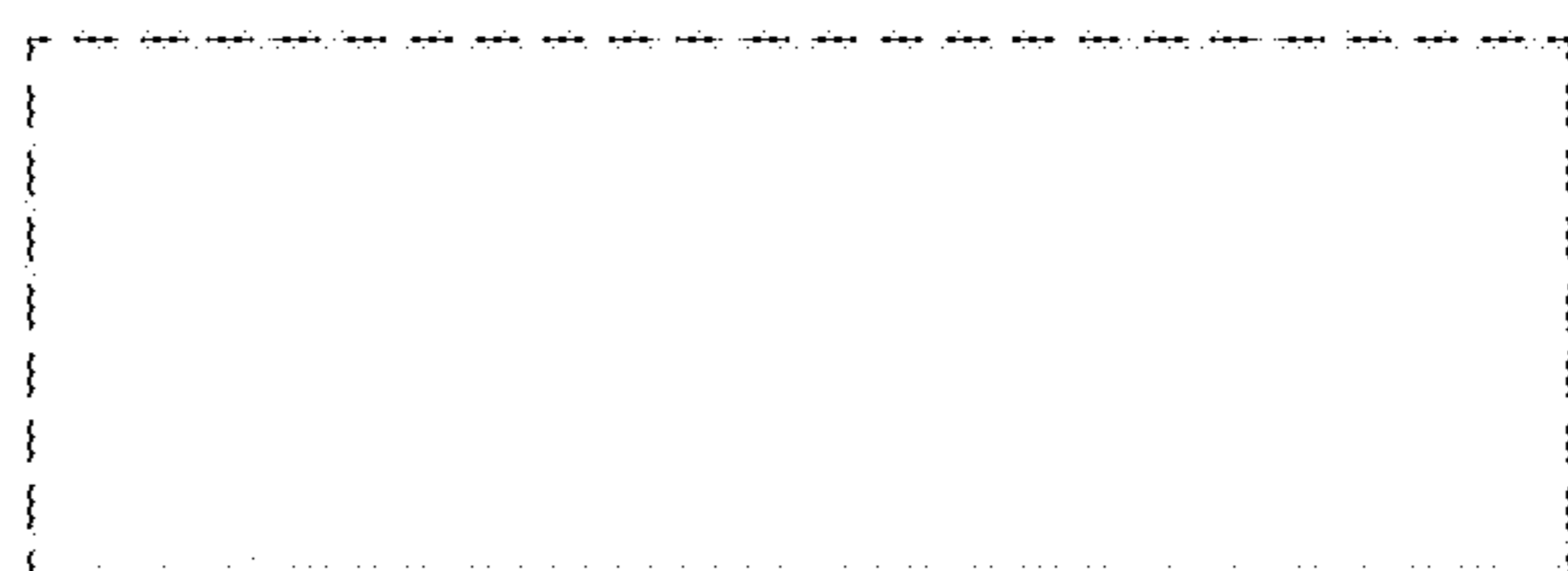

Fig. 6

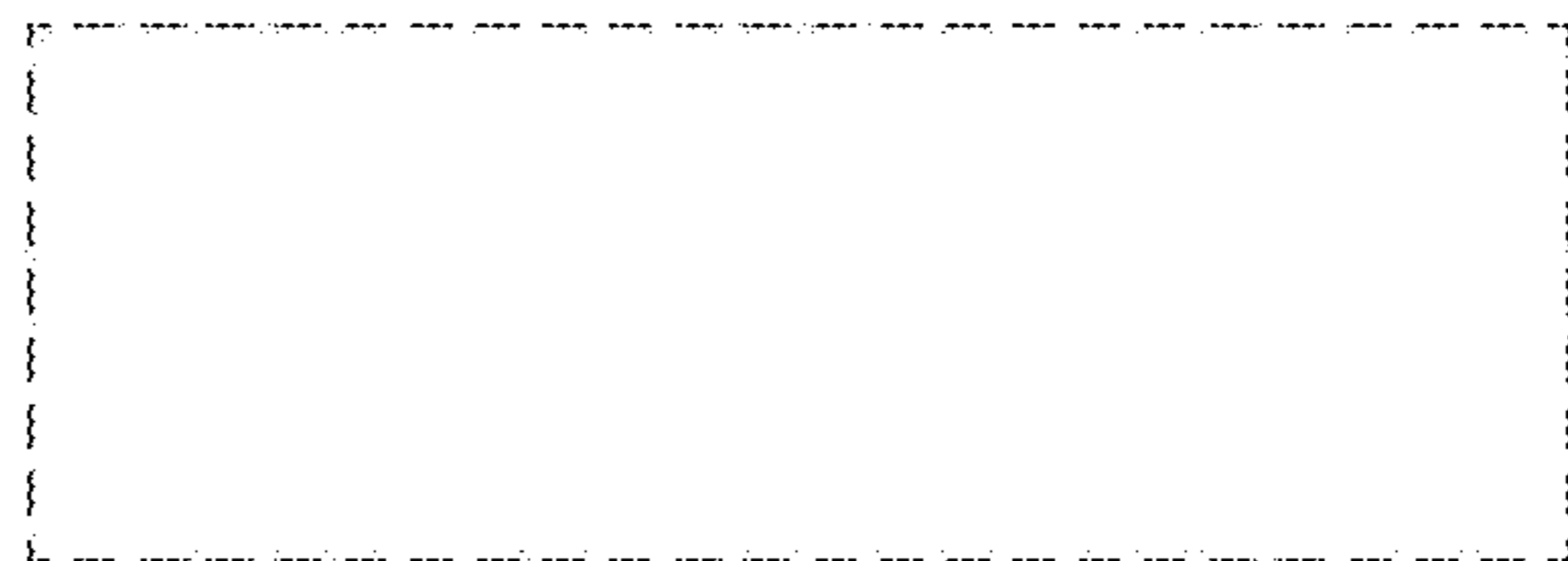

Fig. 7

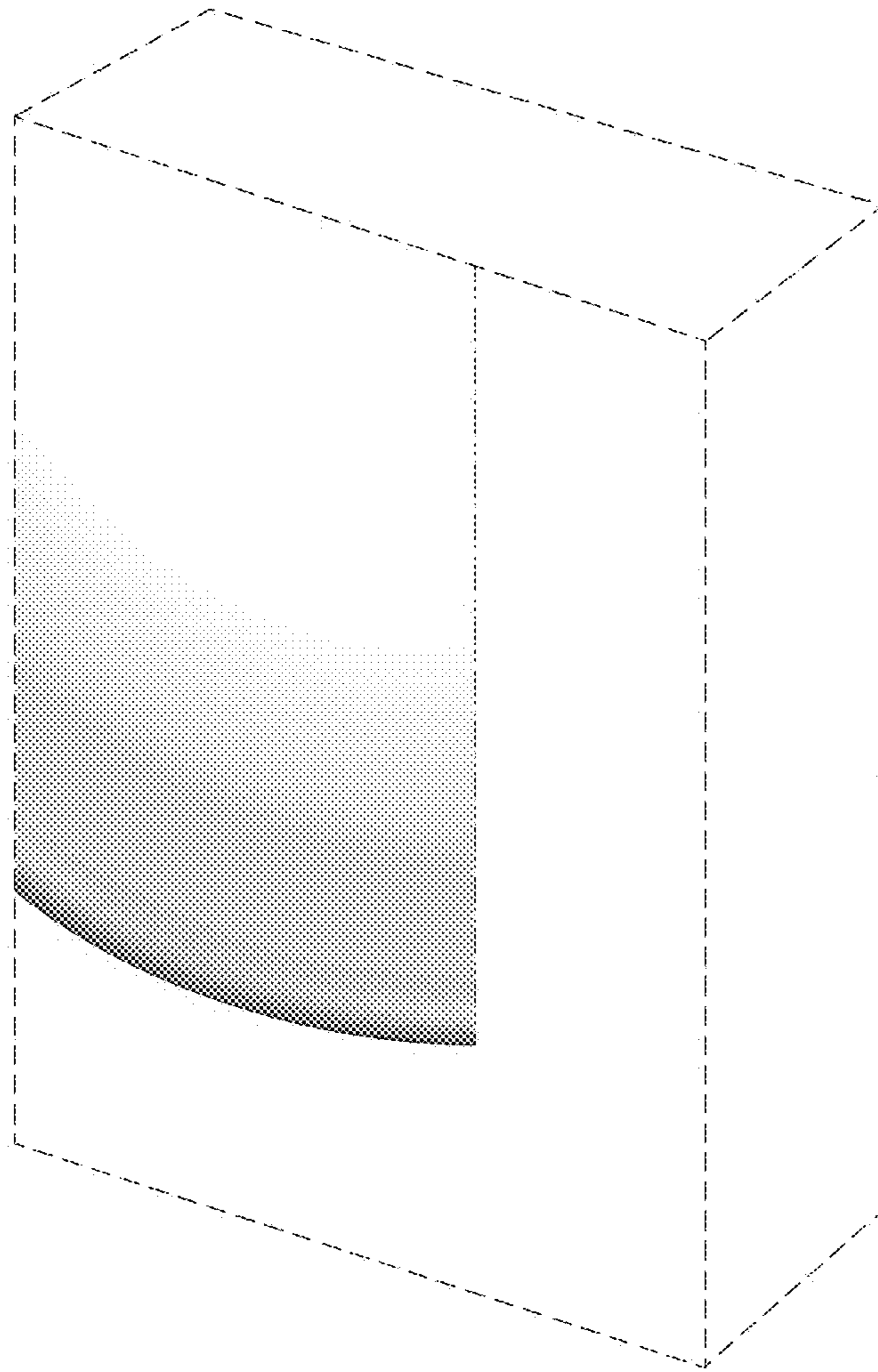

Fig. 8

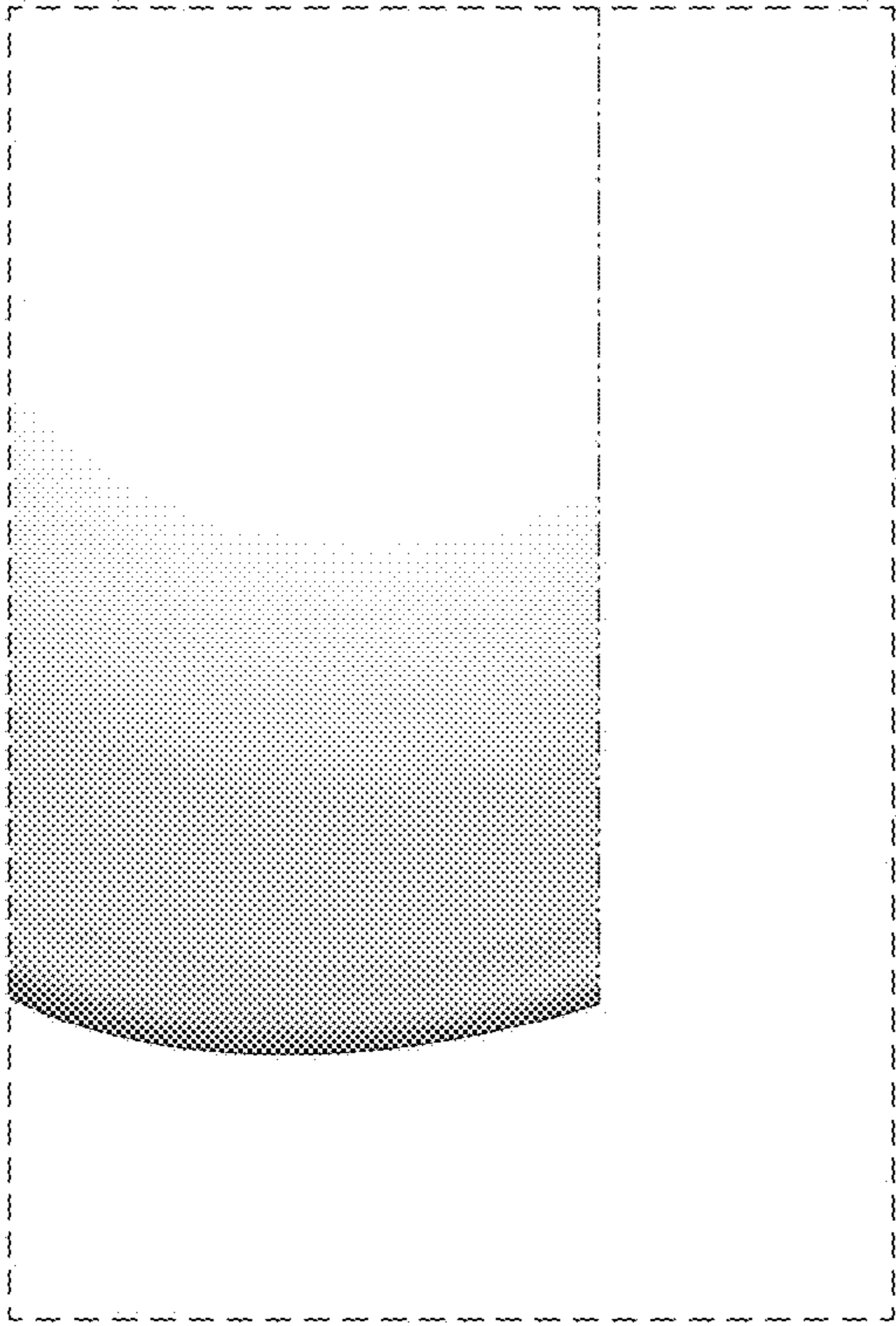

Fig. 9

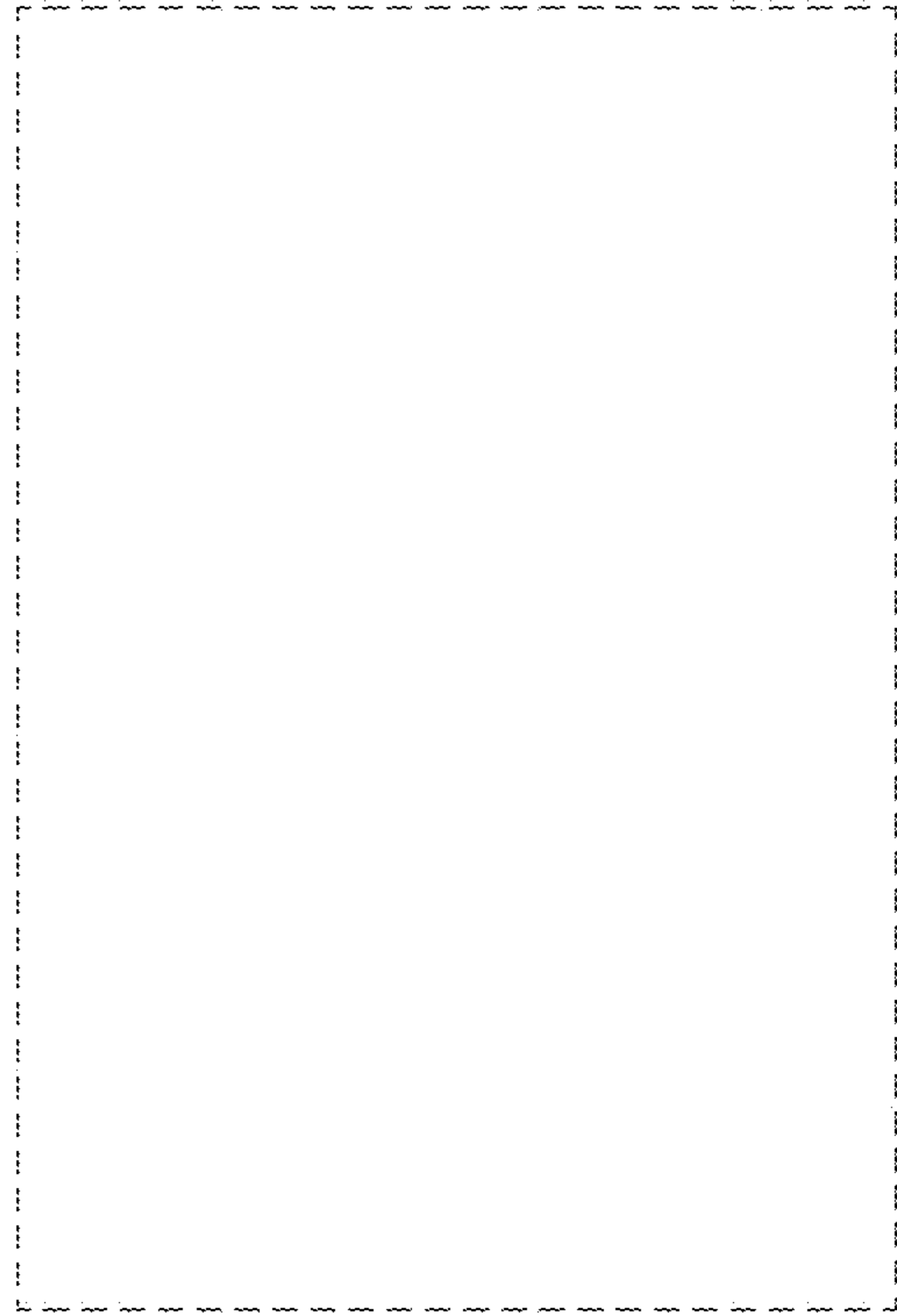

Fig. 12



Fig. 10

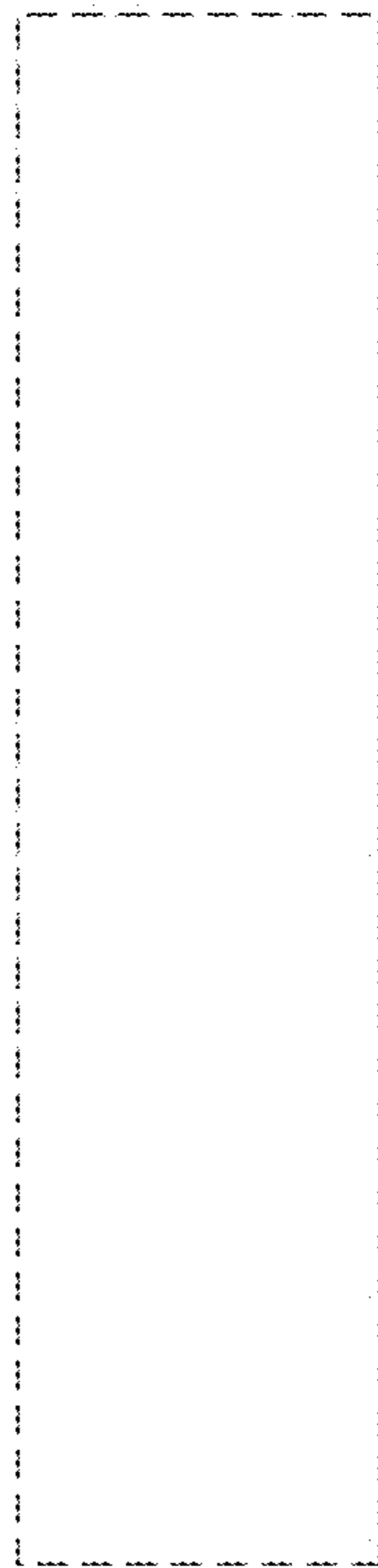

Fig. 11

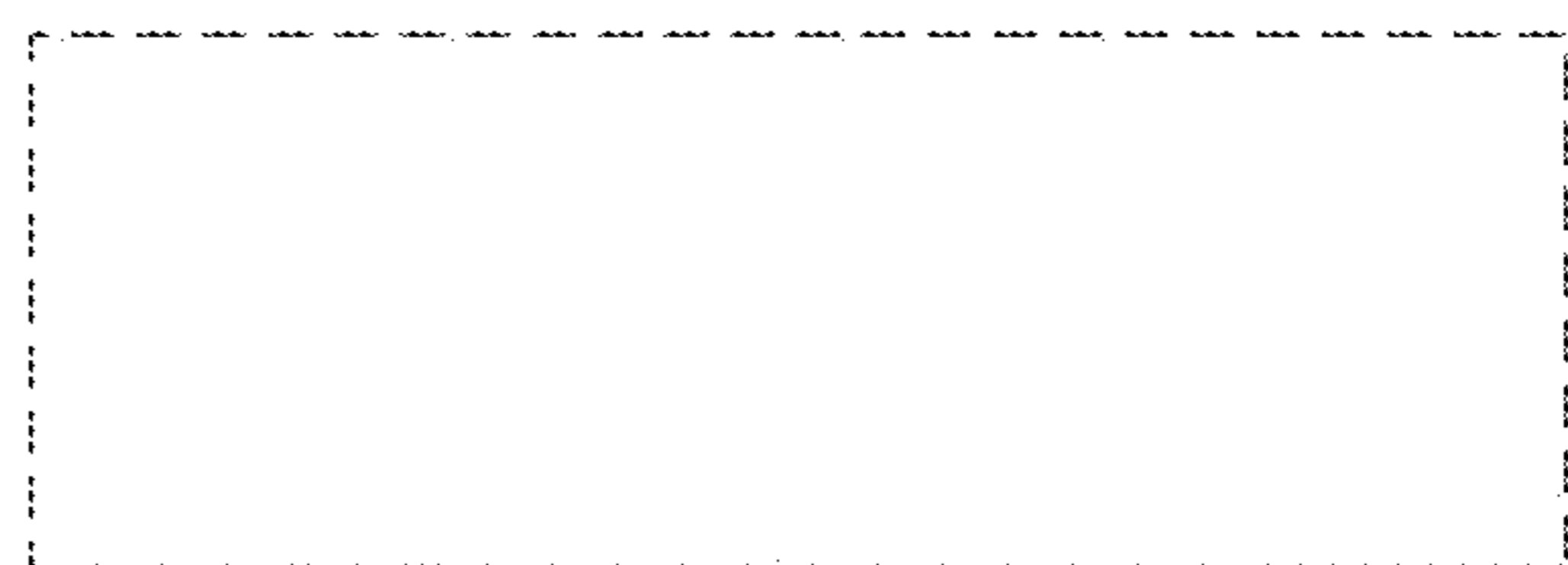

Fig. 13

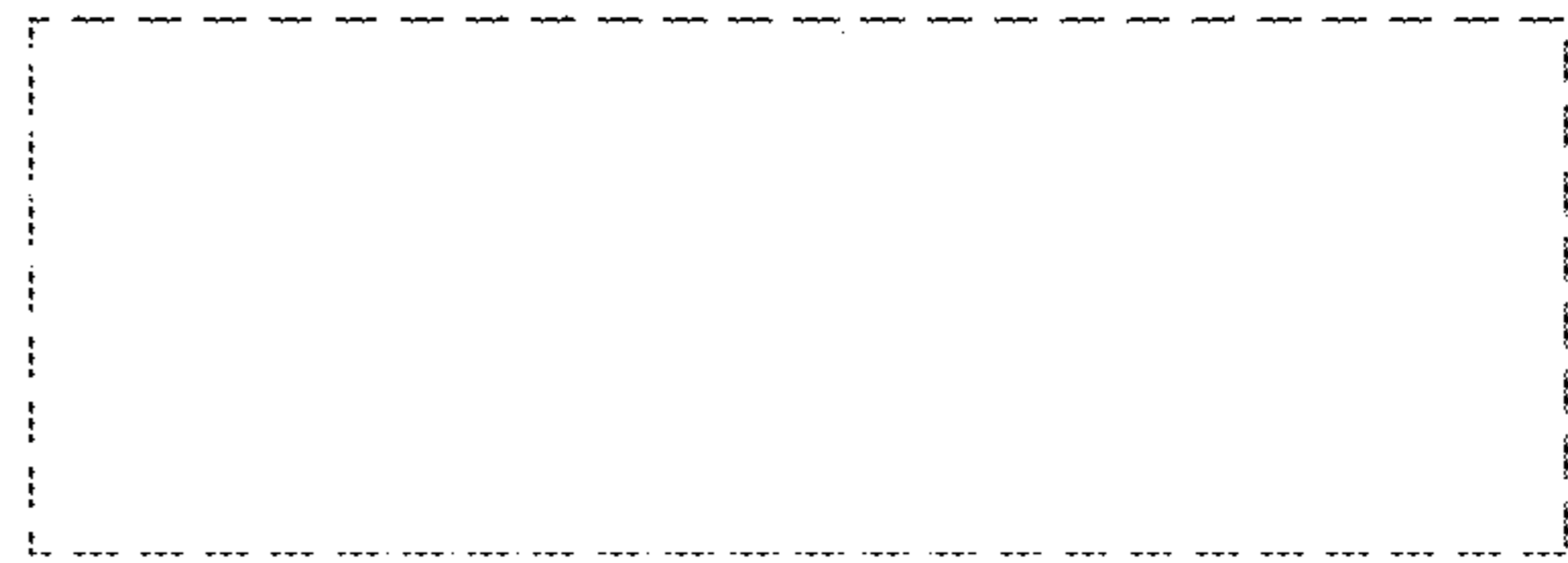

Fig. 14

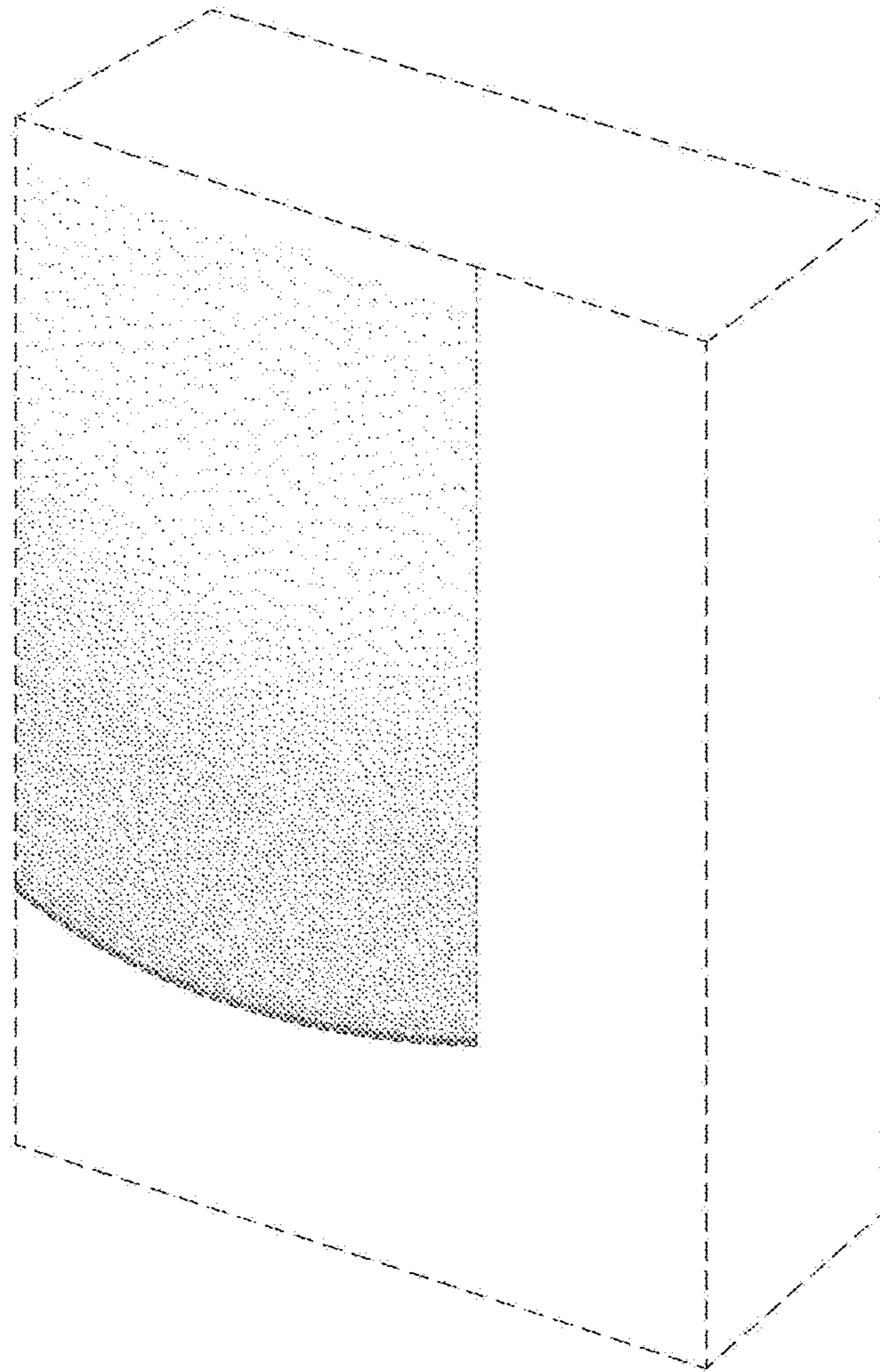

Fig. 15

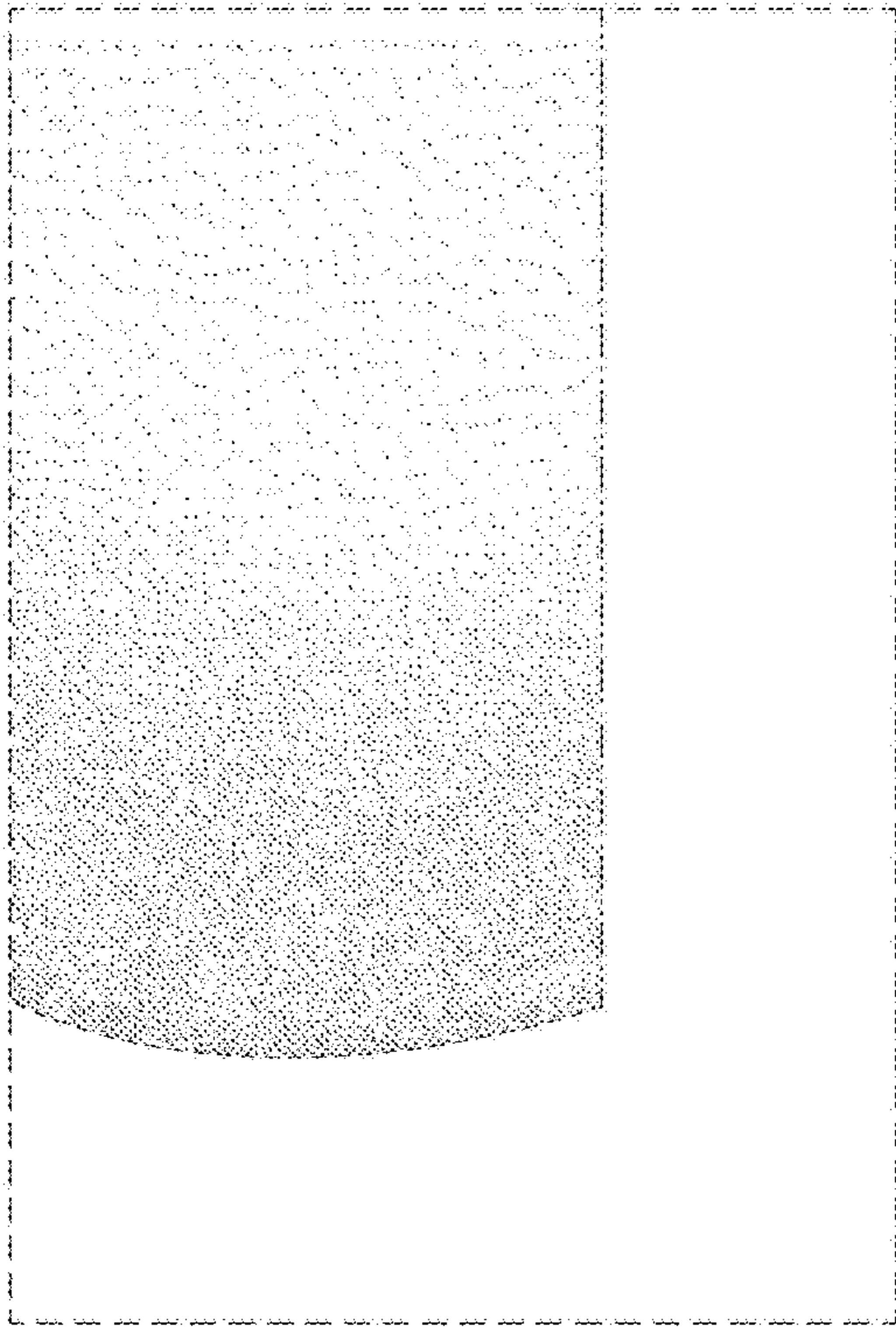

Fig. 16

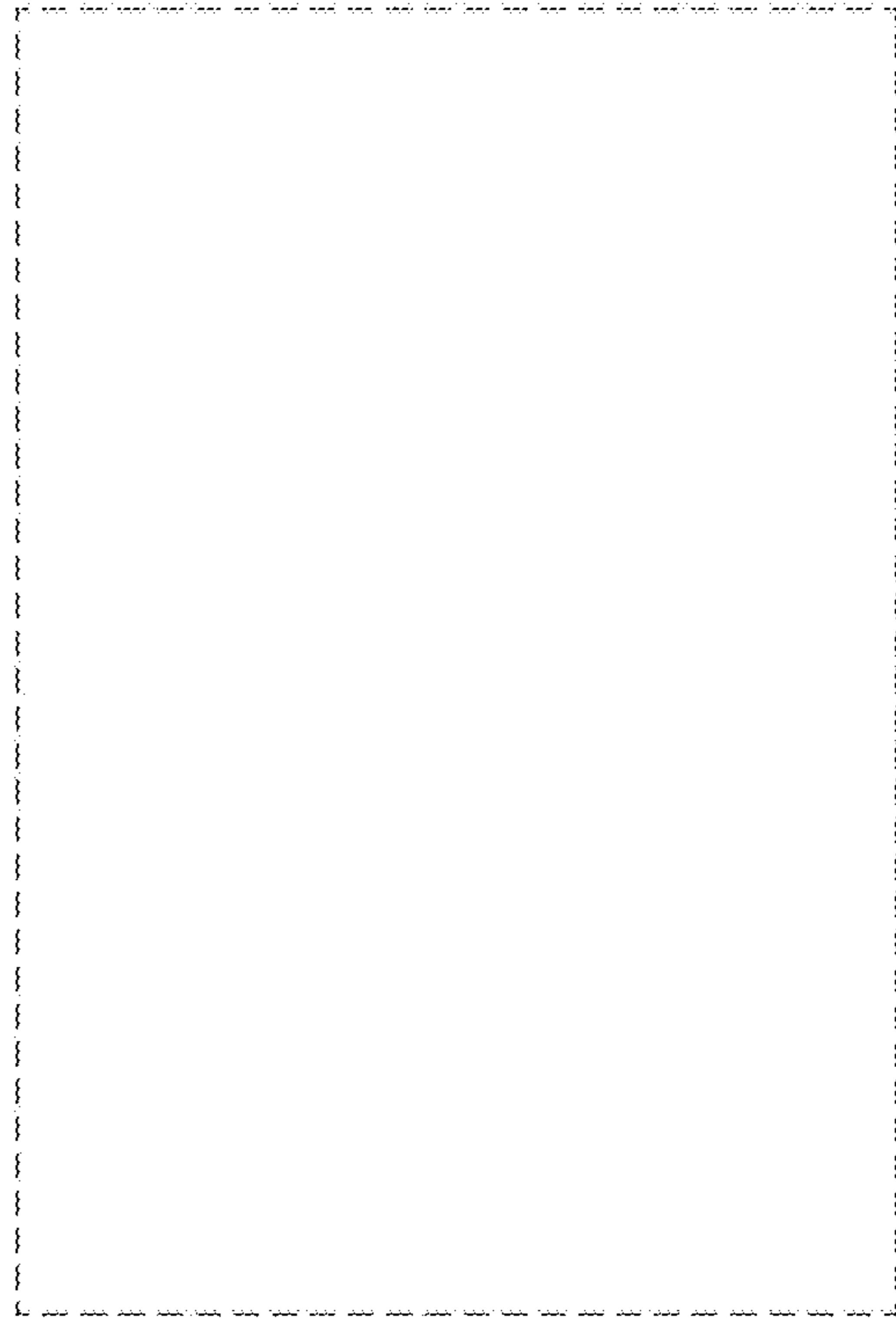

Fig. 19

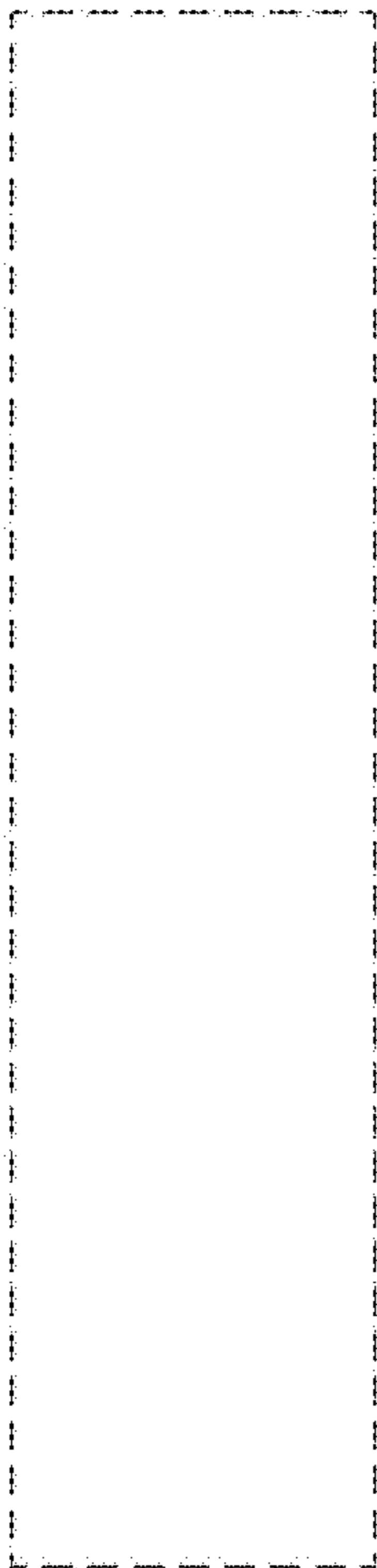

Fig. 17

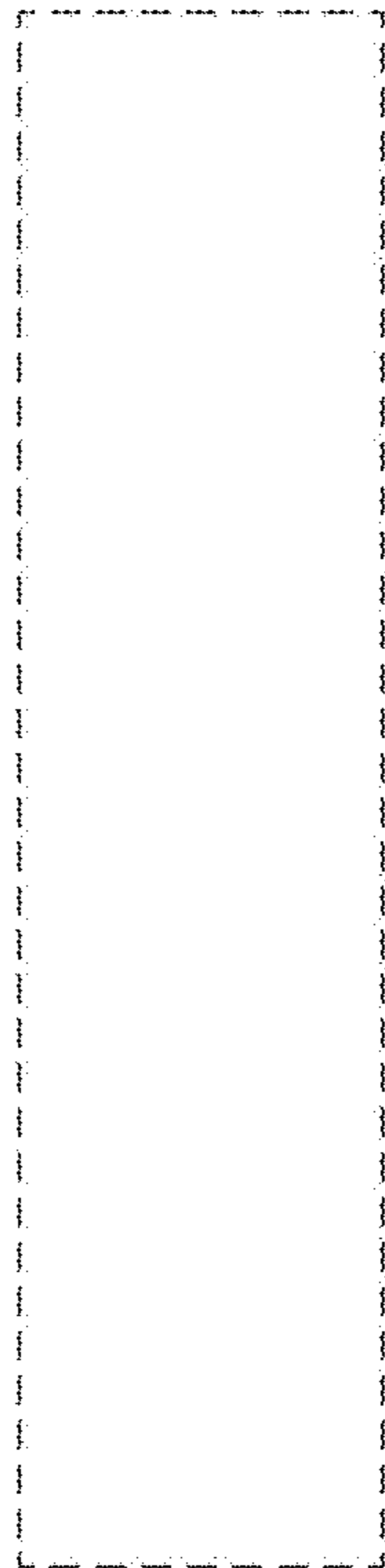

Fig. 18

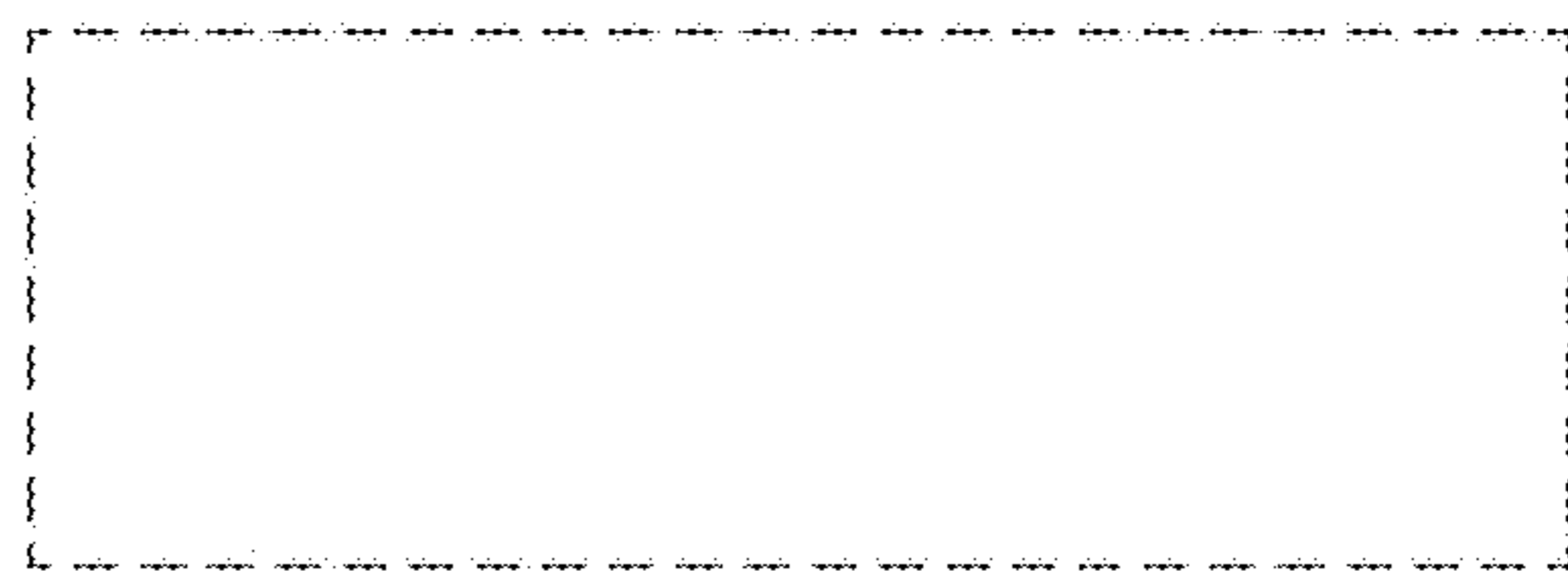

Fig. 20

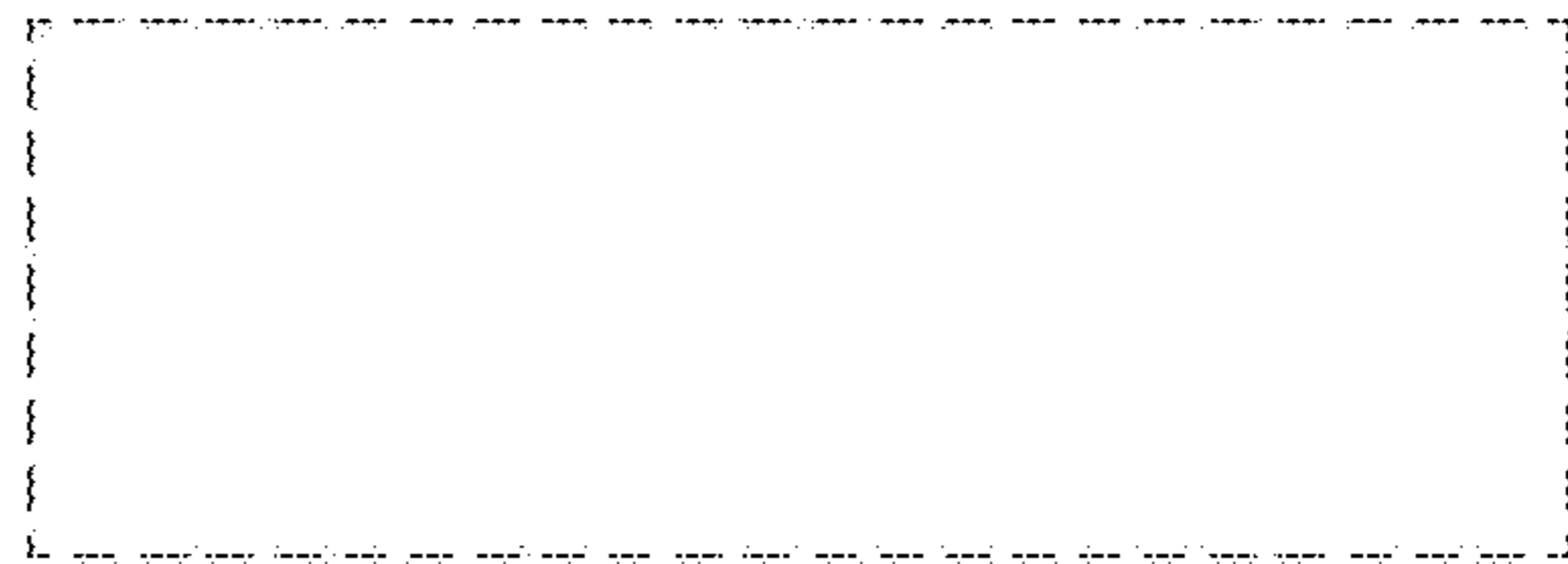

Fig. 21



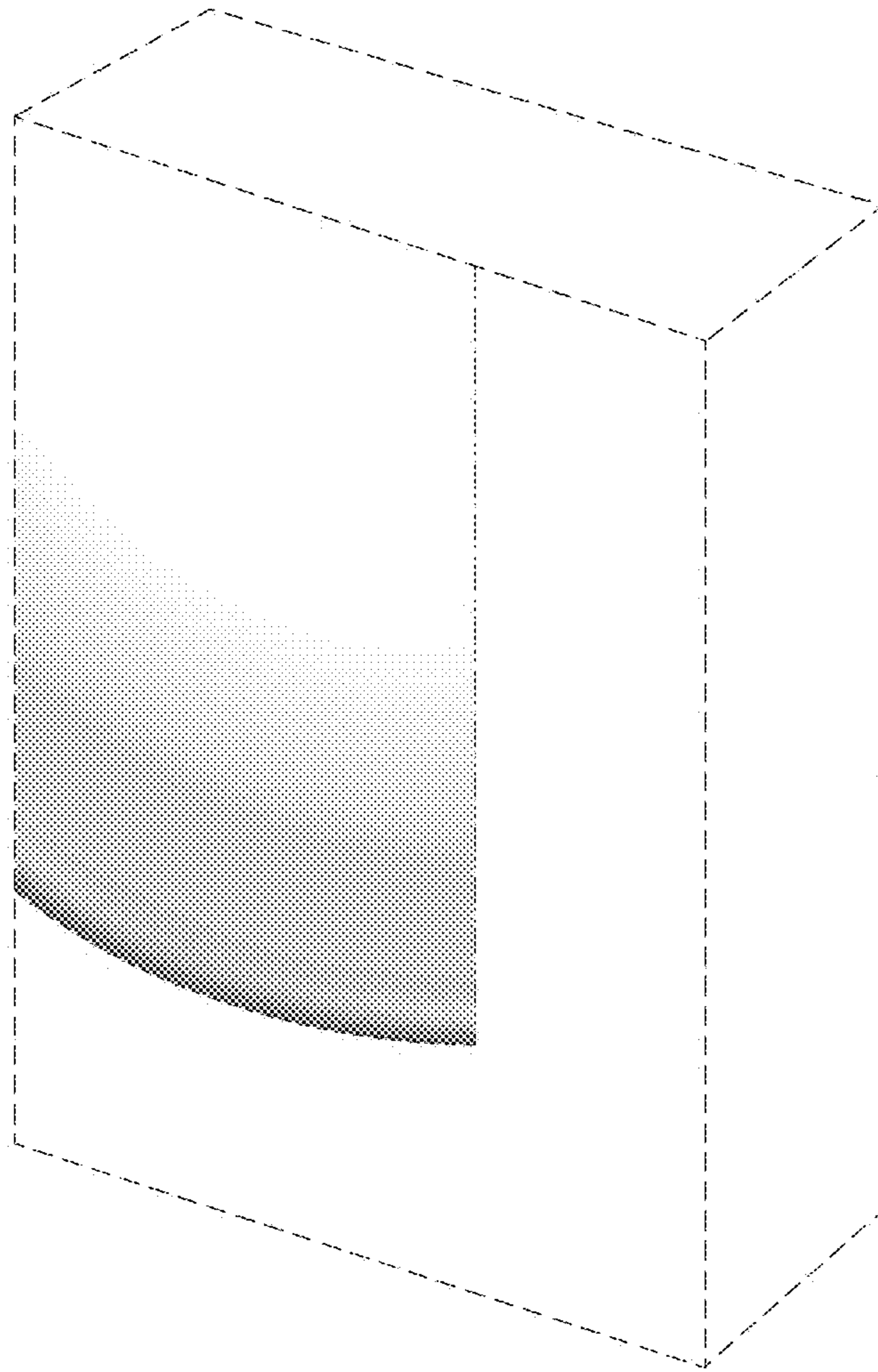

Fig. 22

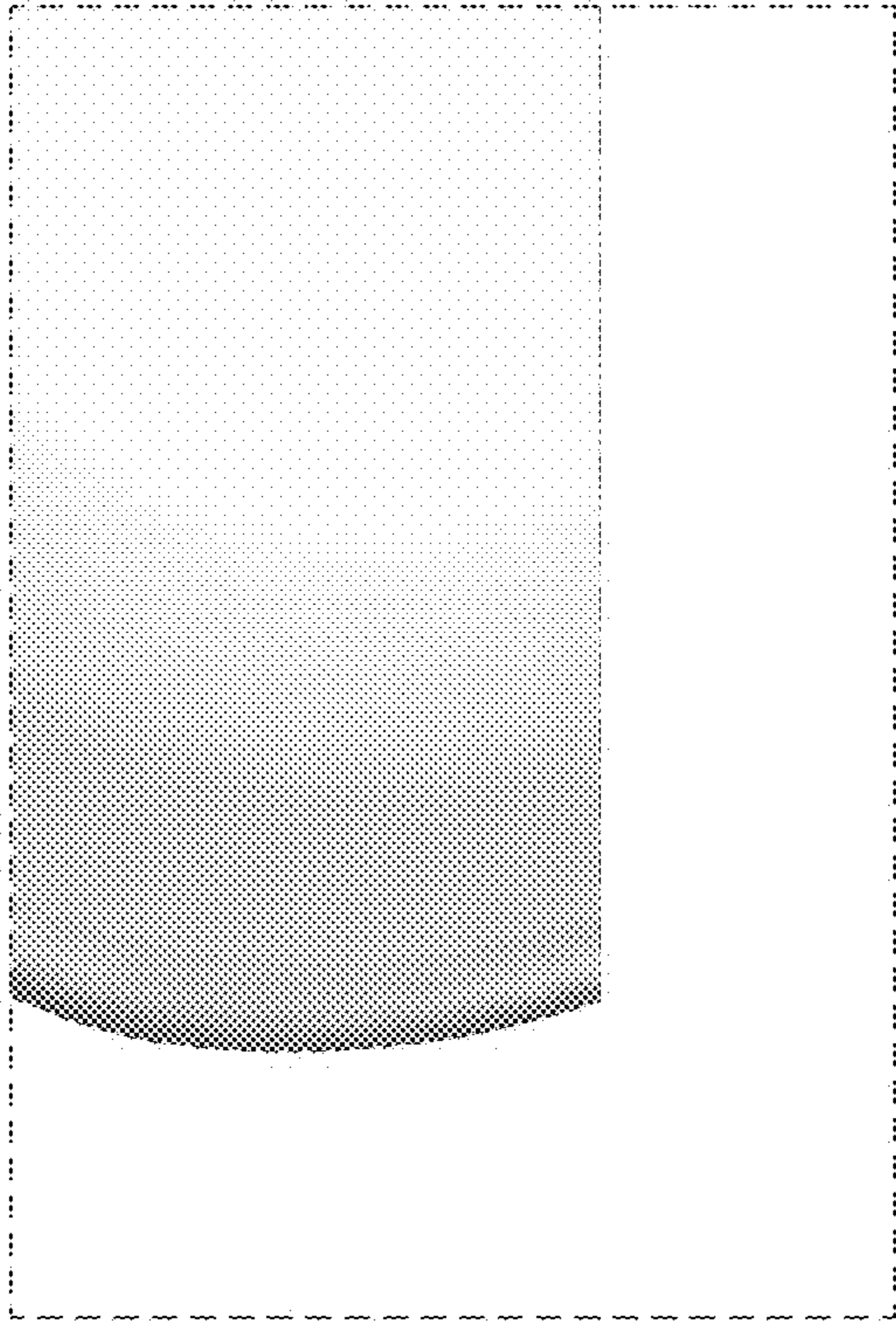

Fig. 23

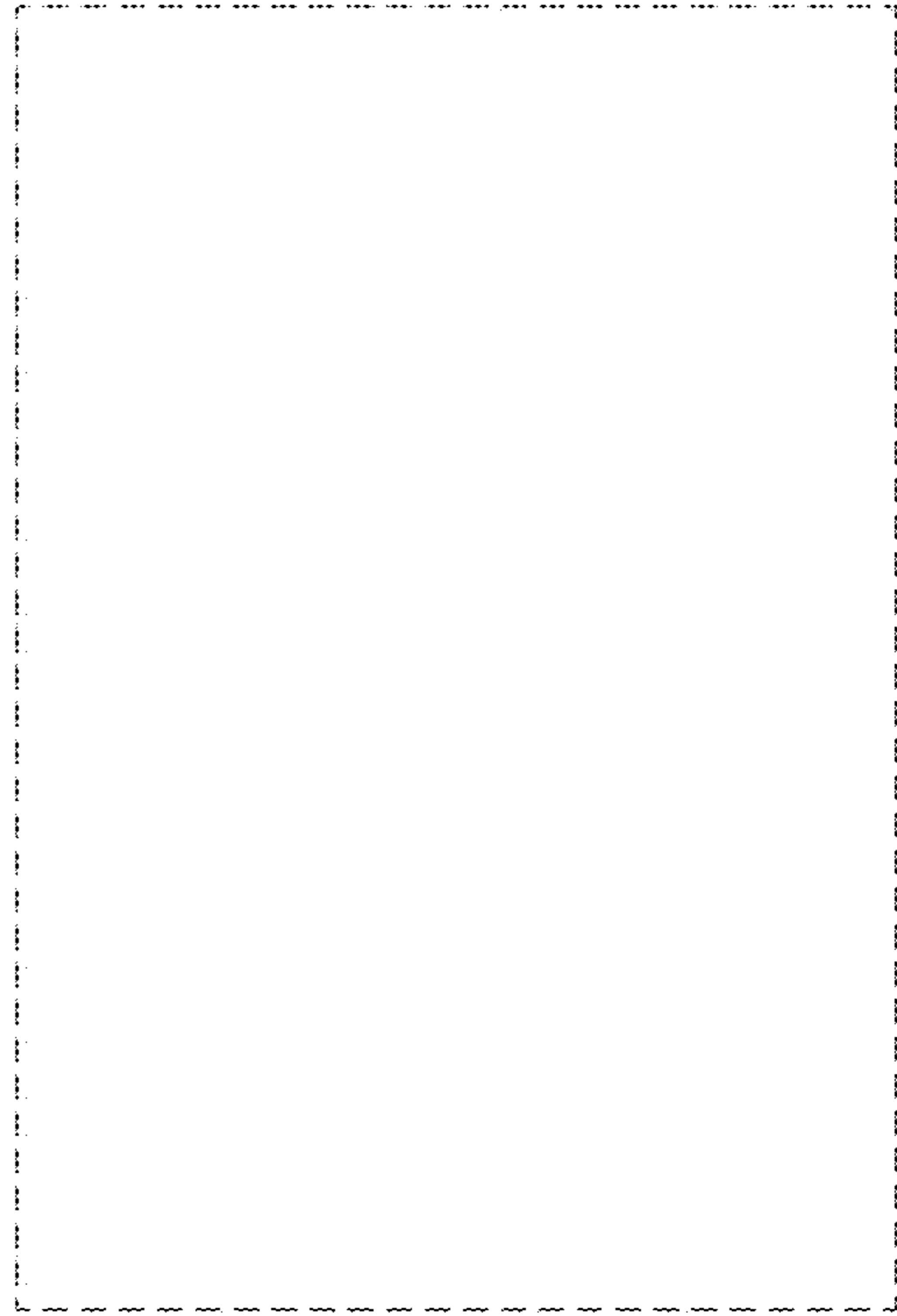

Fig. 26

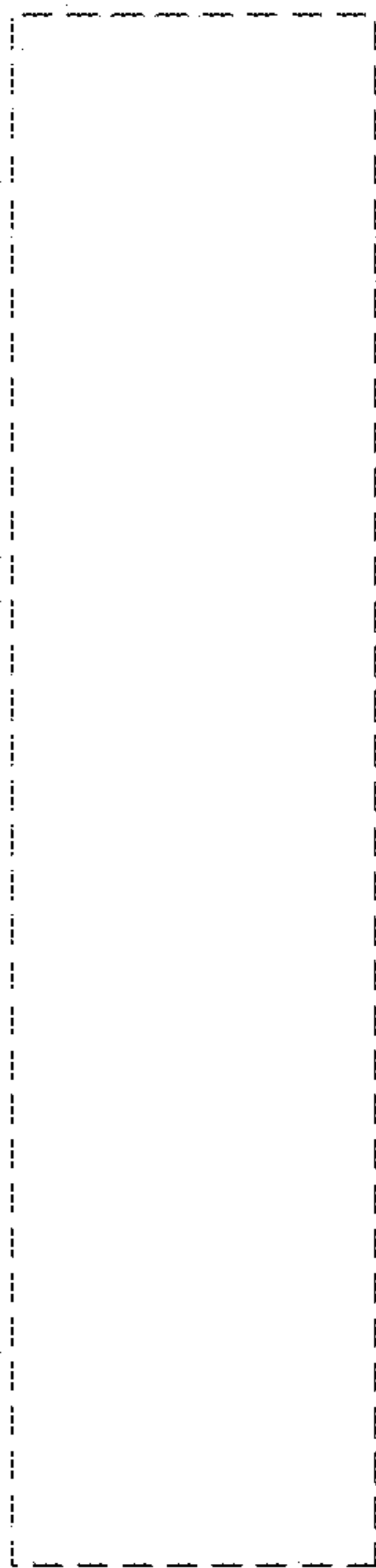

Fig. 24

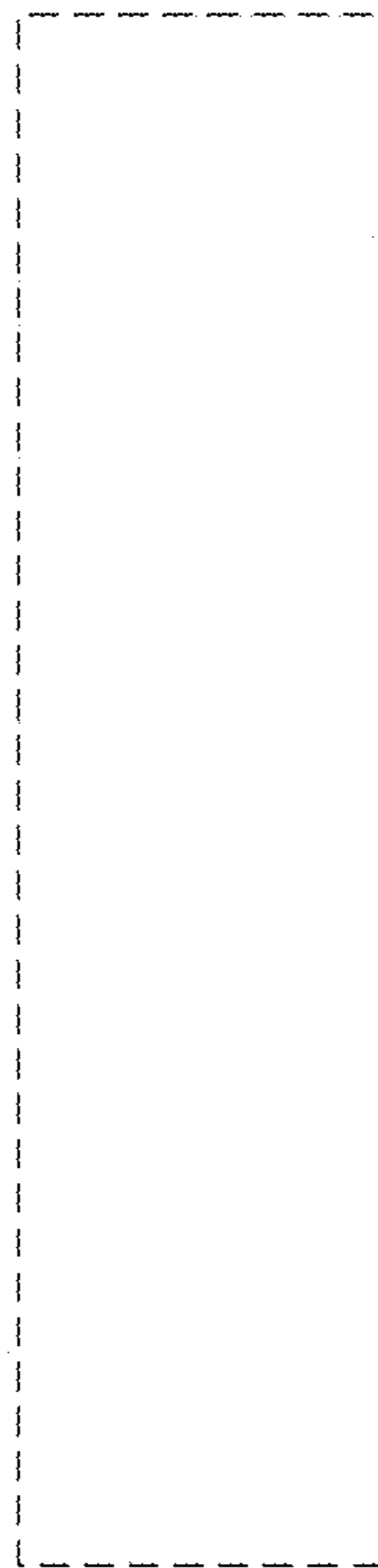

Fig. 25

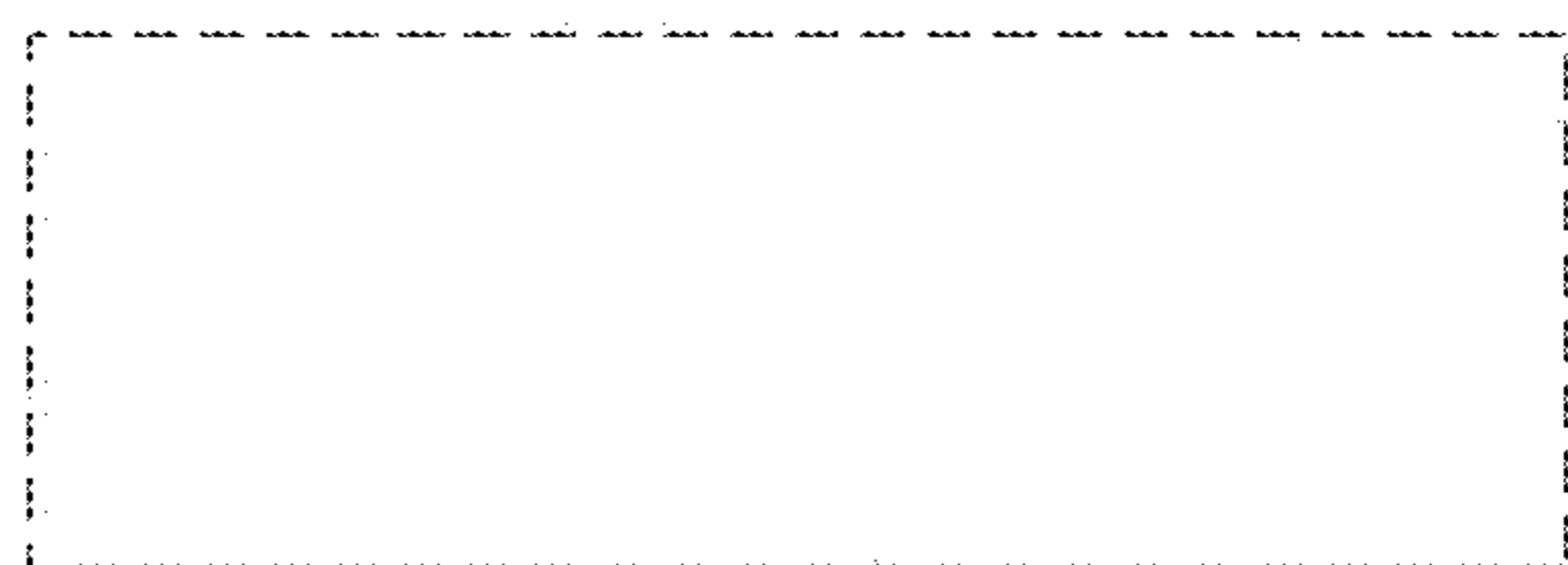

Fig. 27



Fig. 28