

US00D867056S

(12) **United States Design Patent**
Cheng

(10) **Patent No.:** **US D867,056 S**

(45) **Date of Patent:** **** Nov. 19, 2019**

(54) **LID FOR A STORAGE CONTAINER**

(71) Applicant: **Meyer Intellectual Properties Ltd.**,
Kowloon (HK)

(72) Inventor: **Stanley Kin Sui Cheng**, Hillsborough,
CA (US)

(73) Assignee: **Meyer Intellectual Properties Limited**
(VG)

(**) Term: **15 Years**

(21) Appl. No.: **29/653,062**

(22) Filed: **Jun. 12, 2018**

(51) **LOC (12) Cl.** **07-02**

(52) **U.S. Cl.**
USPC **D7/391**

(58) **Field of Classification Search**
USPC D7/391, 392, 392.1, 393, 397, 601–602,
D7/629–630, 538–542; D9/414, 416,
D9/424–432, 435, 438, 451–454
CPC A47J 36/027; A47J 36/06; A47J 37/10;
A47J 37/101; B65D 21/0209; B65D
43/00; B65D 43/02; B65D 43/0206;
B65D 43/0212; B65D 43/0218; B65D
43/021; B65D 43/022; B65D 43/161;
B65D 43/162; B65D 45/00; B65D 45/16;
B65D 45/18; B65D 45/32; B65D 51/16;
B65D 51/1683; B65D 51/1688; B65D
51/1694; B65D 2251/00; B65F 1/1615
See application file for complete search history.

(56) **References Cited**

U.S. PATENT DOCUMENTS

- 3,109,575 A * 11/1963 Aldington B65D 43/021
229/123.2
- 3,515,306 A * 6/1970 Roper B65D 43/0212
220/792
- 4,412,630 A * 11/1983 Daenen B65D 43/0218
220/792

(Continued)

Primary Examiner — Ricky Pham

(74) *Attorney, Agent, or Firm* — Edward S. Sherman

(57) **CLAIM**

The ornamental design for a lid for a storage container,
substantially as shown and described.

DESCRIPTION

FIG. 1 is a perspective view of the “lid for a storage container”, showing my new design;
 FIG. 2 is a right side elevation view thereof;
 FIG. 3 is a left side elevation view thereof;
 FIG. 4 is a front side elevation view thereof;
 FIG. 5 is a back side elevation view thereof;
 FIG. 6 is a top plan view thereof;
 FIG. 7 is a bottom plan view thereof;
 FIG. 8 is a perspective view of a second embodiment of the “lid for a storage container”, showing my new design;
 FIG. 9 is a right side elevation view thereof;
 FIG. 10 is a left side elevation view thereof;
 FIG. 11 is a front side elevation view thereof;
 FIG. 12 is a back side elevation view thereof;
 FIG. 13 is a top plan view thereof;
 FIG. 14 is a bottom plan view thereof;
 FIG. 15 is a perspective view of a third embodiment of the “lid for a storage container”, showing my new design;
 FIG. 16 is a right side elevation view thereof;
 FIG. 17 is a left side elevation view thereof;
 FIG. 18 is a front side elevation view thereof;
 FIG. 19 is a back side elevation view thereof;
 FIG. 20 is a top plan view thereof; and,
 FIG. 21 is a bottom plan view thereof.
 Color is not a claimed feature of the design.
 The broken lines in the drawings represent unclaimed portions of the design.

1 Claim, 15 Drawing Sheets

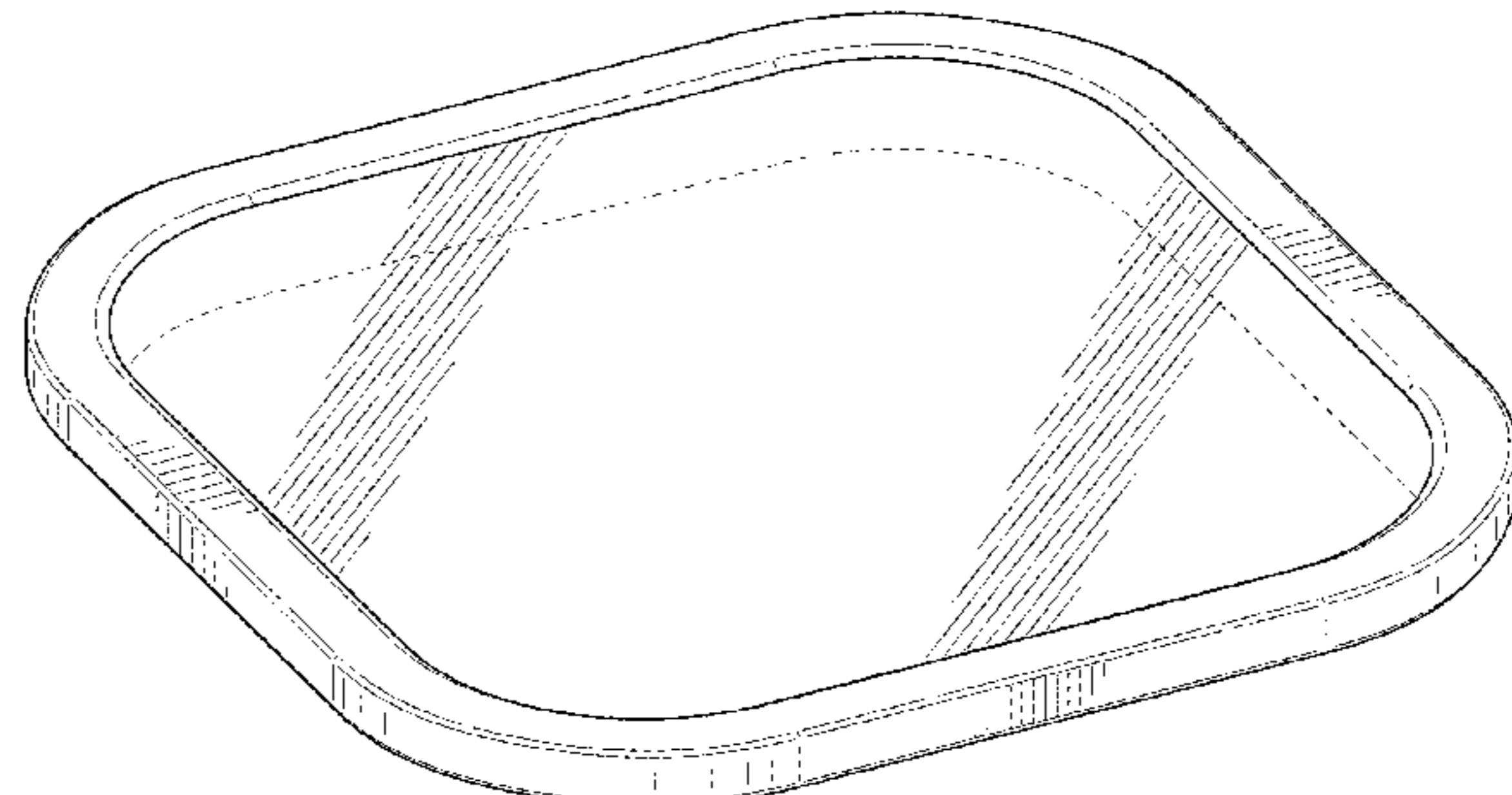
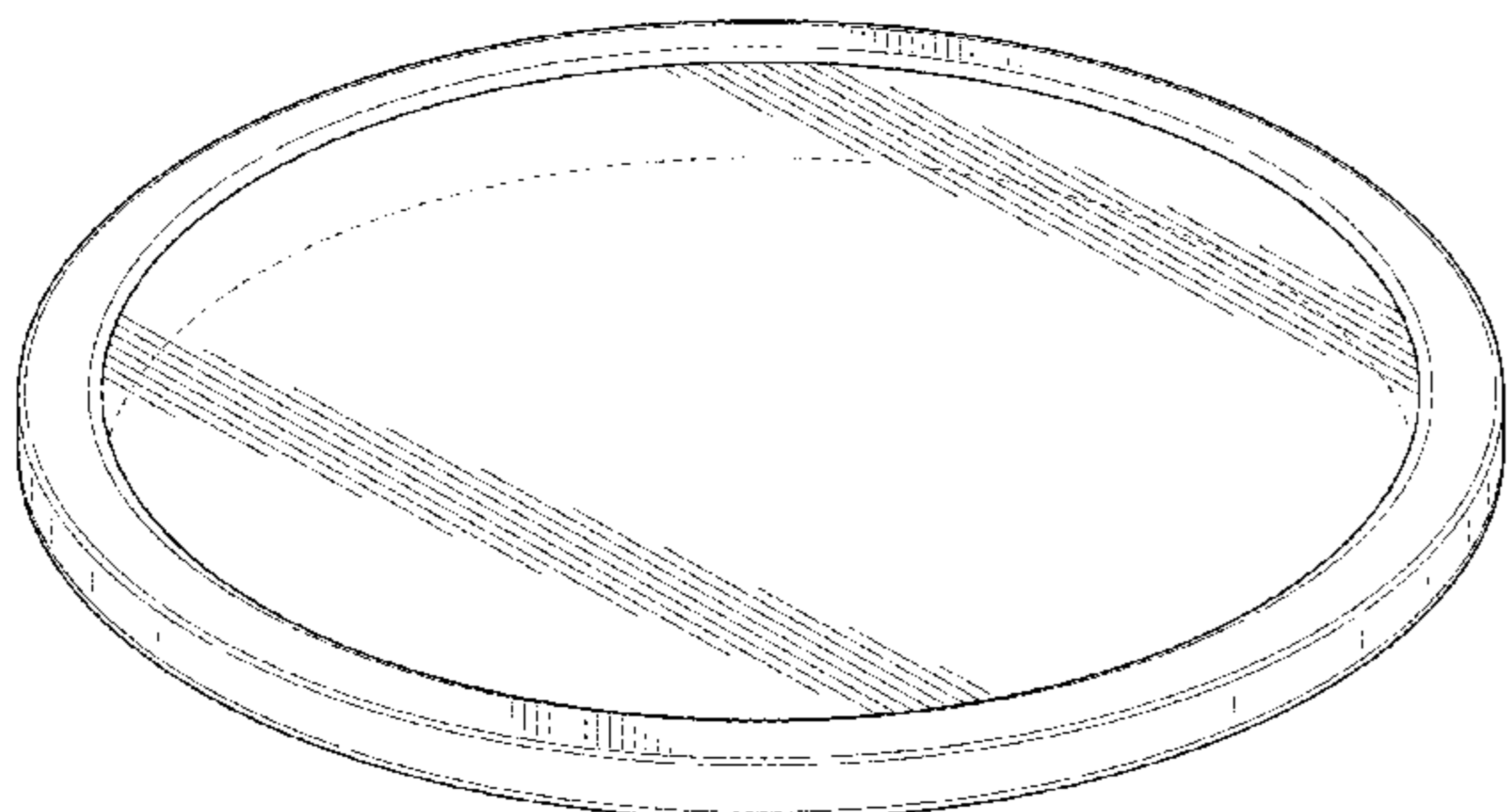

(56)

References Cited

U.S. PATENT DOCUMENTS

D286,026 S	*	10/1986	Rayner	D9/435
D389,058 S	*	1/1998	Landis	D9/438
D398,997 S	*	9/1998	Taylor	D23/386
D502,049 S	*	2/2005	Munson	D7/392.1
D628,894 S	*	12/2010	Pontes	D9/454
D730,112 S	*	5/2015	Yessin	D7/392.1
D731,241 S	*	6/2015	Yessin	D7/392.1
D774,887 S	*	12/2016	Torrison	D9/416
D801,110 S	*	10/2017	Sarnoff	D7/391
D816,500 S	*	5/2018	Torrison	B65D 43/0218 D9/454

* cited by examiner

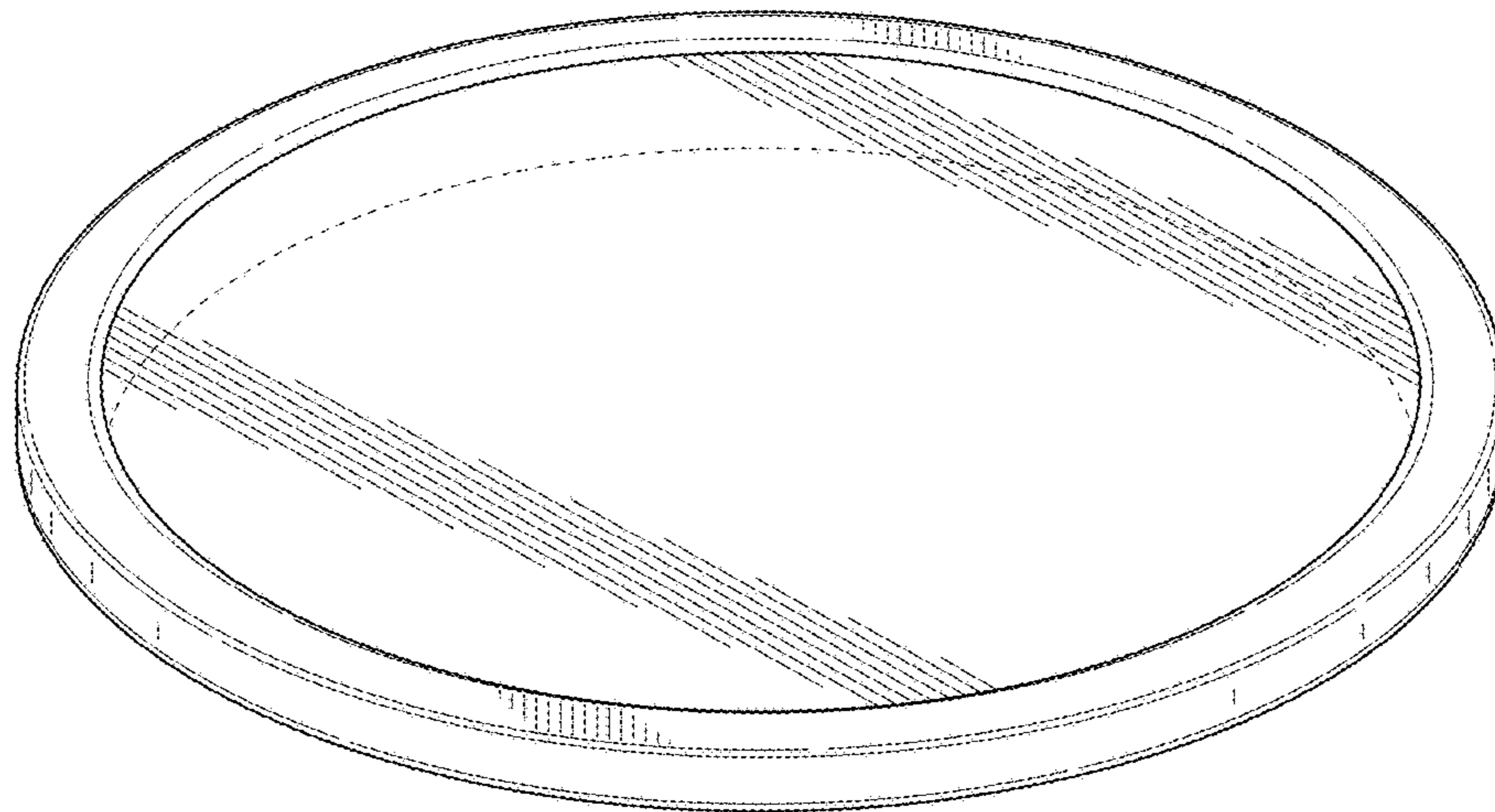

FIG. 1

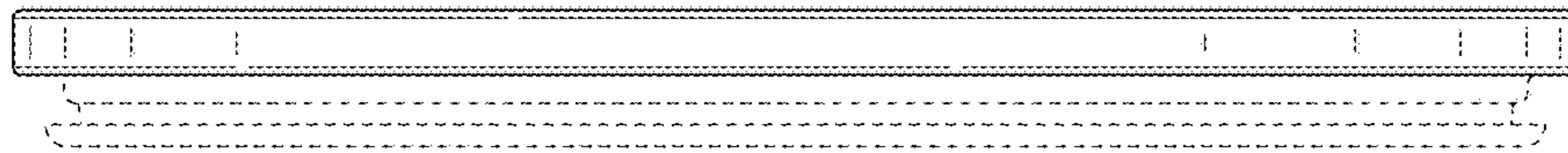

FIG. 2

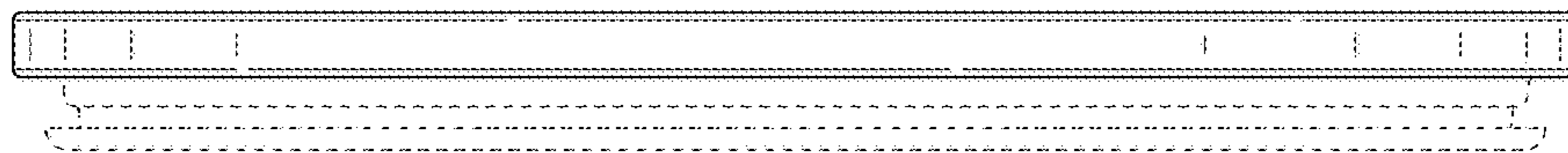

FIG. 3

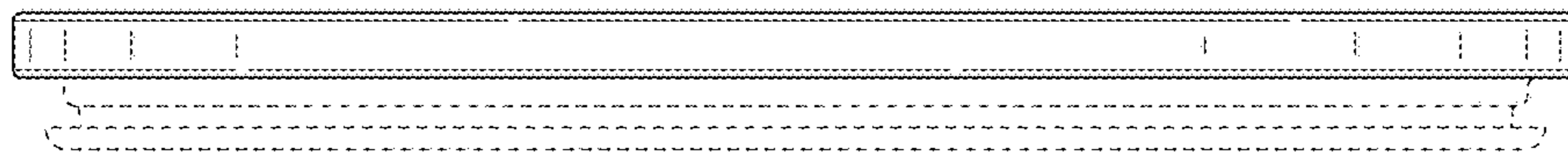

FIG. 4

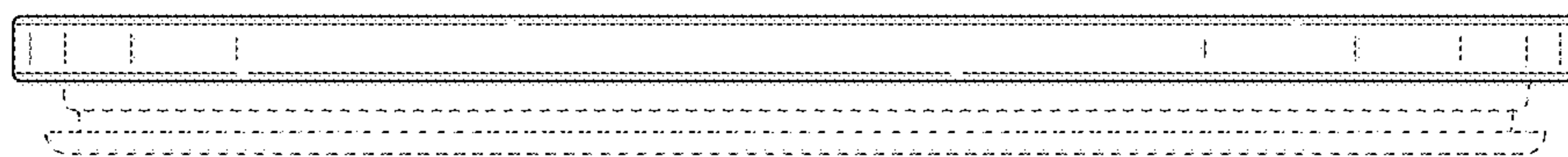

FIG. 5

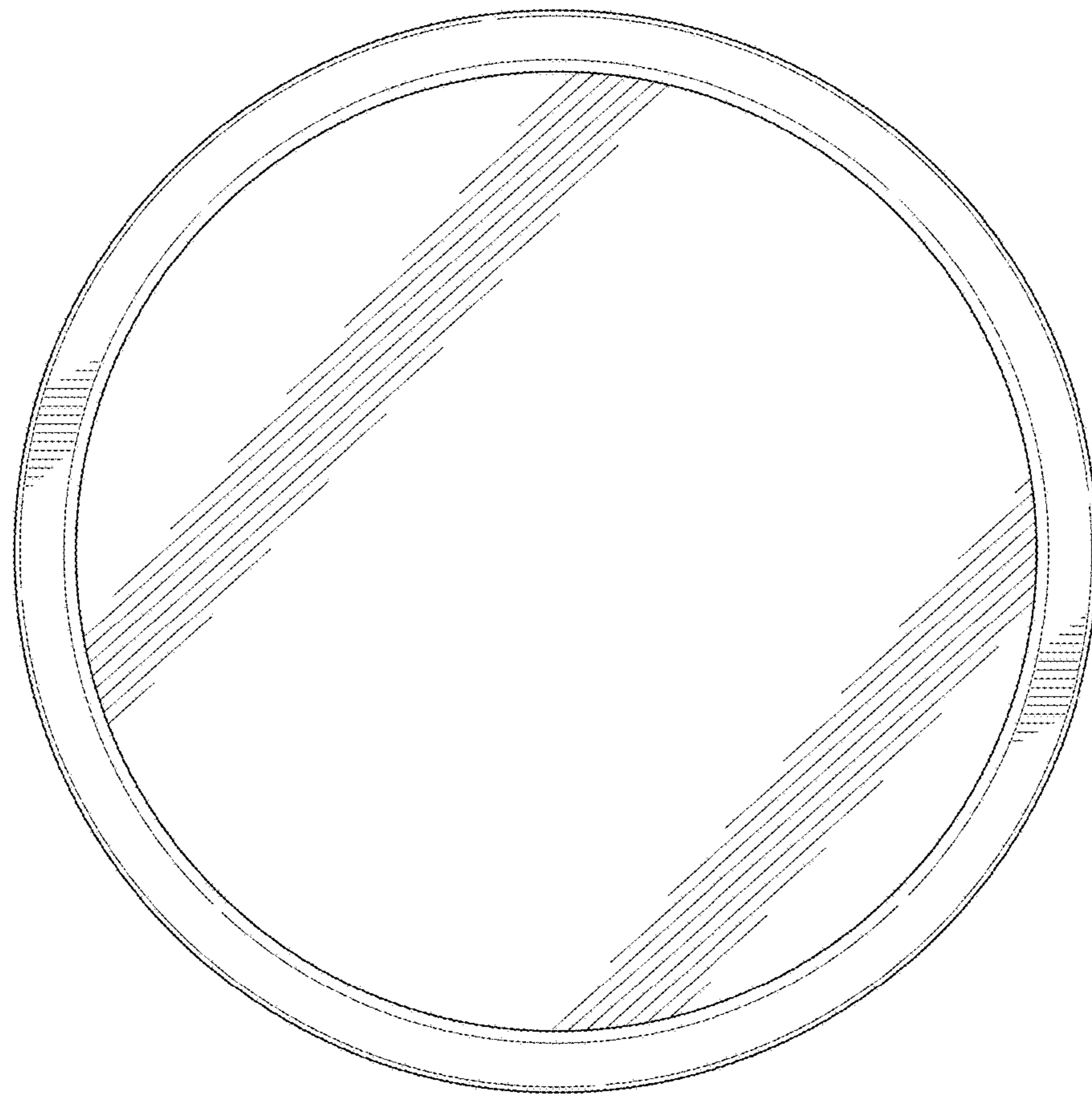

FIG. 6

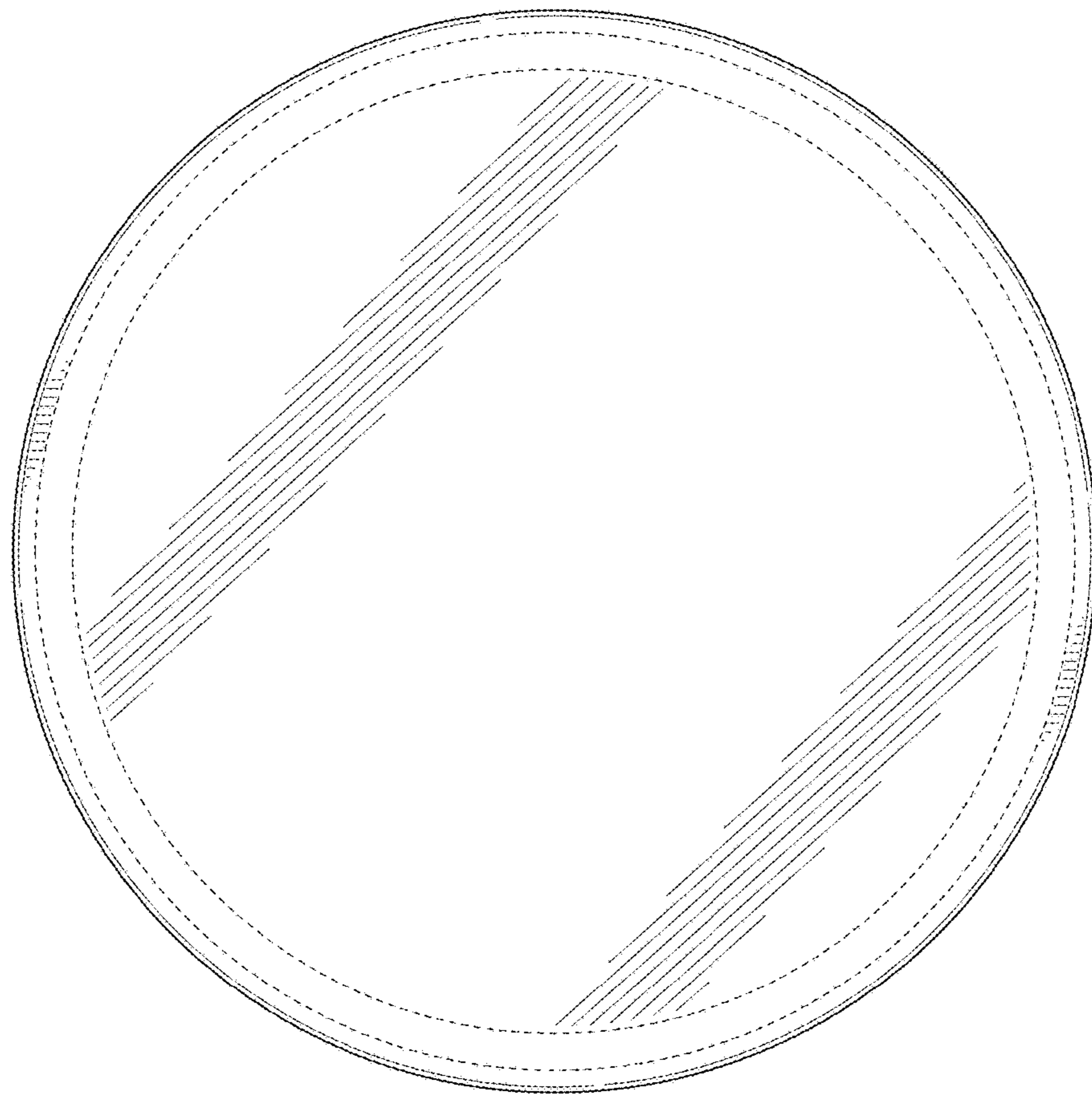

FIG. 7

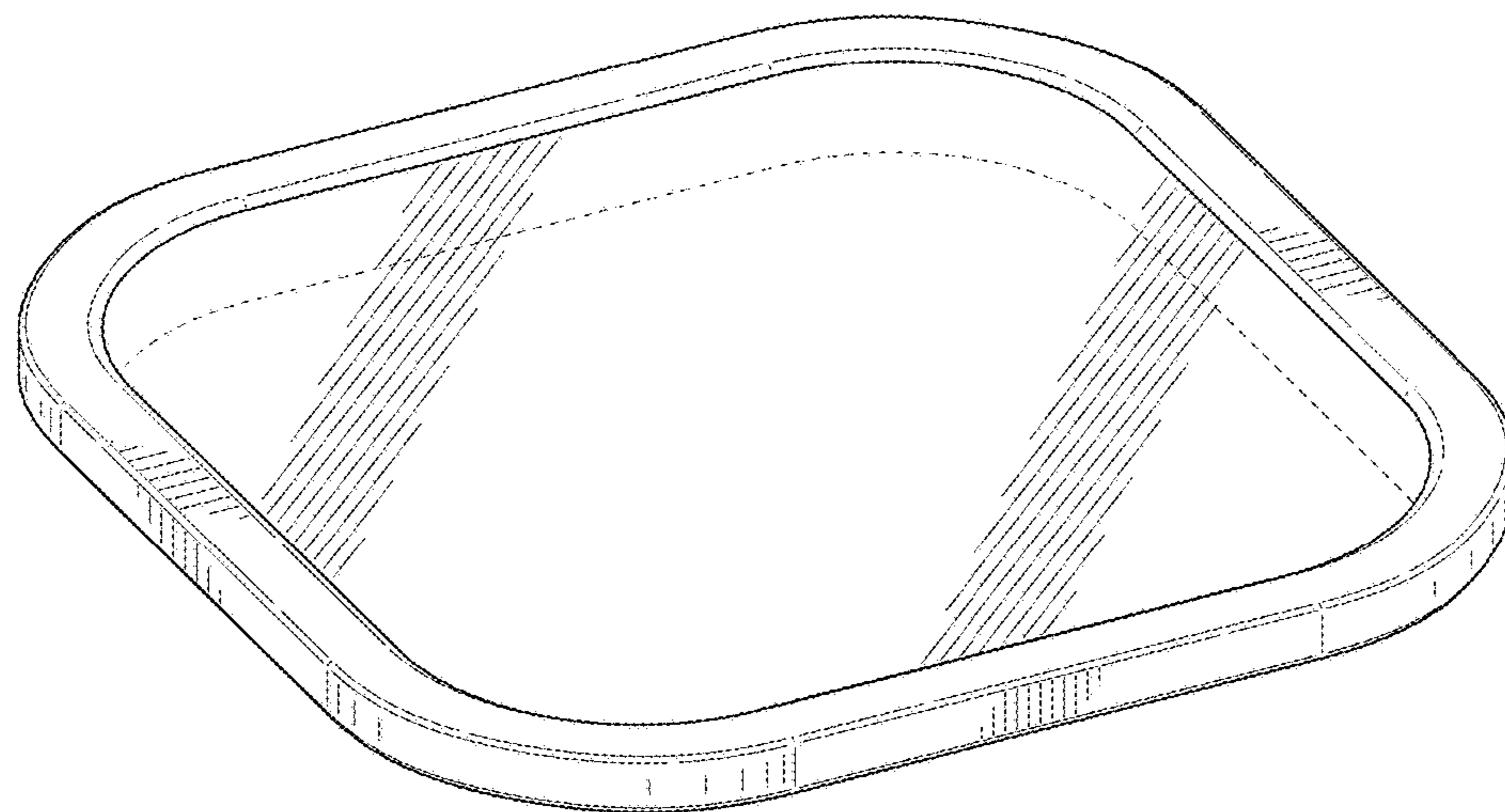

FIG. 8

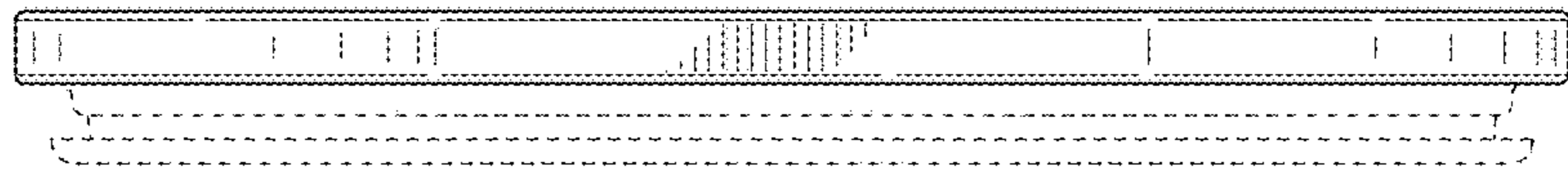

FIG. 9

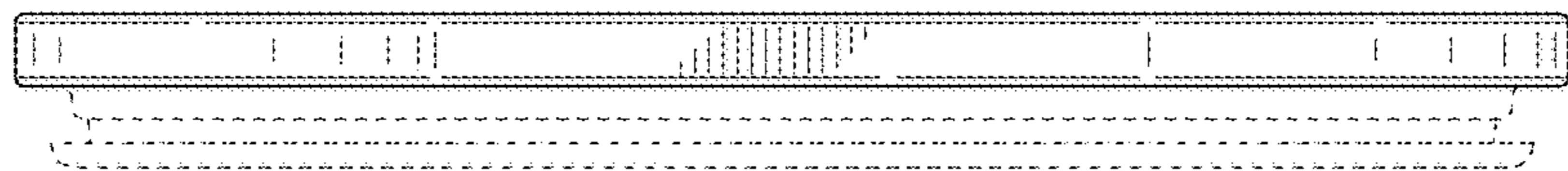

FIG. 10

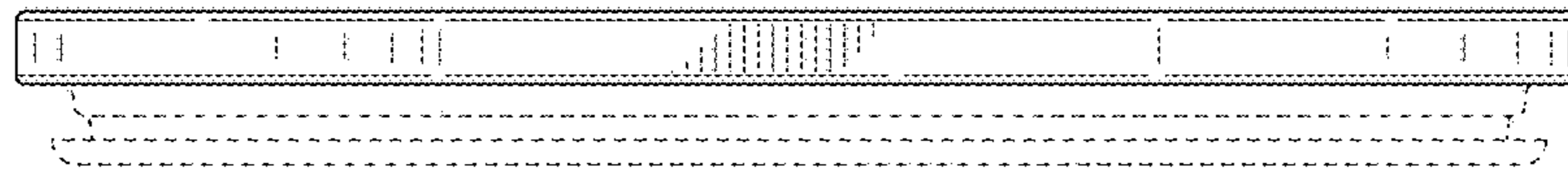

FIG. 11

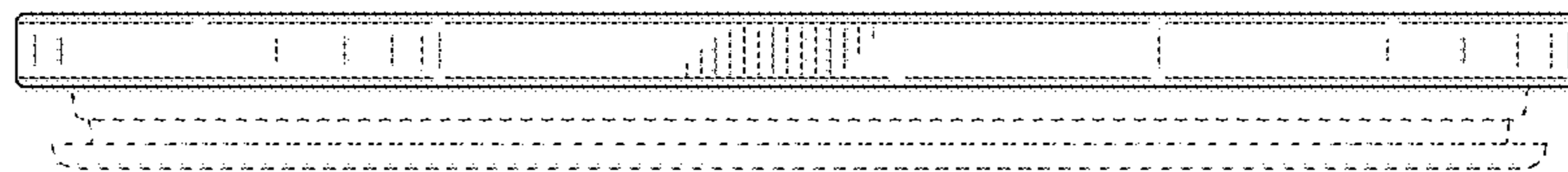

FIG. 12

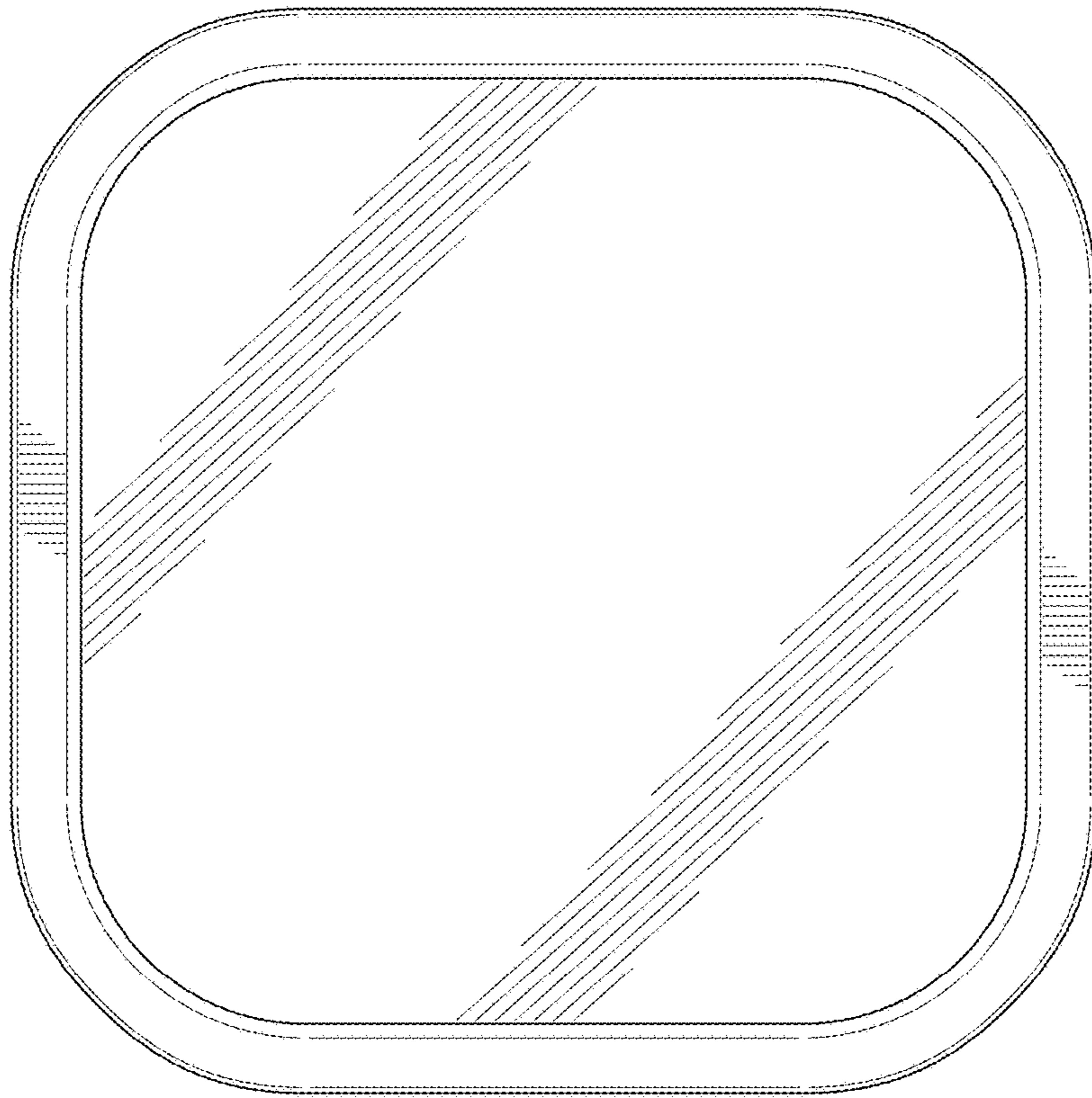

FIG. 13

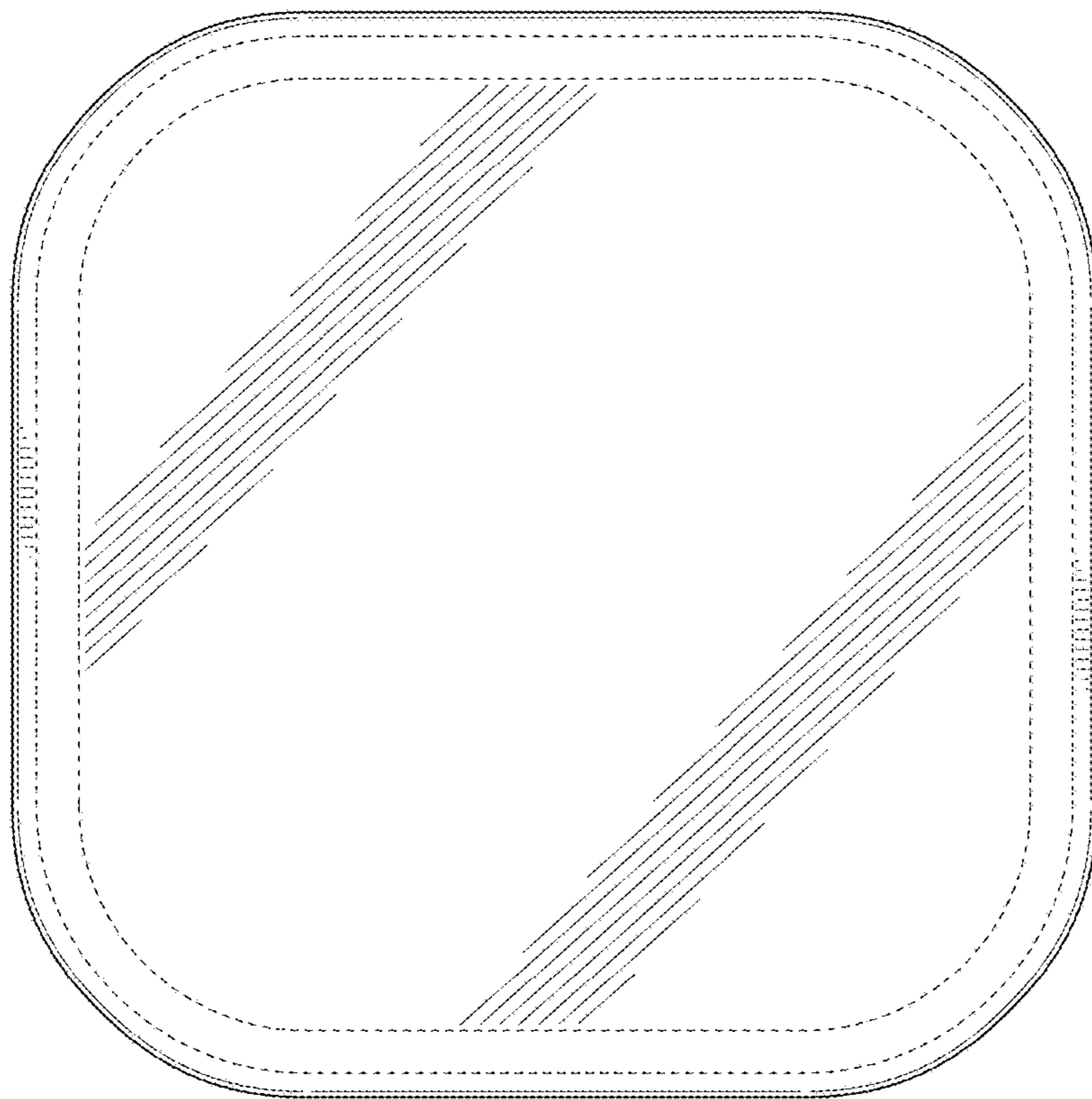

FIG. 14

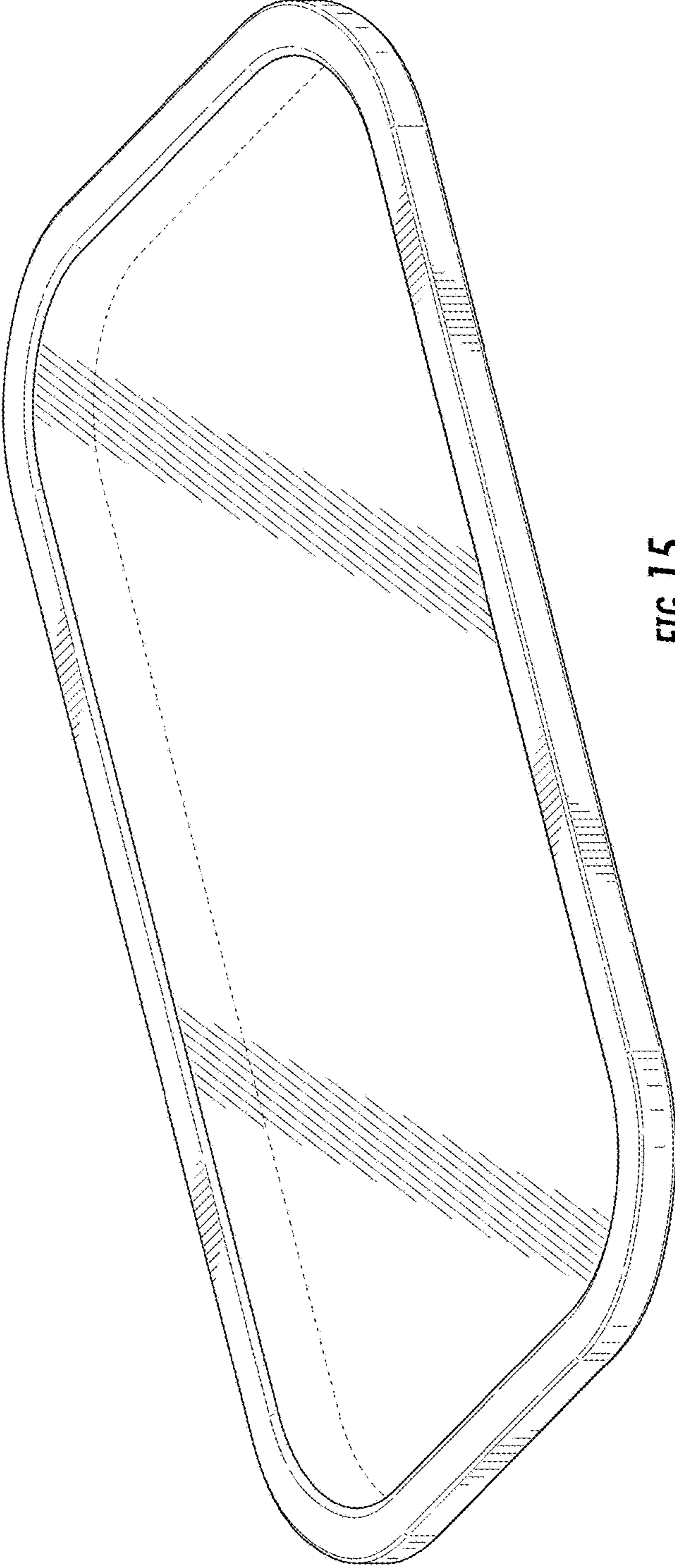

FIG. 15

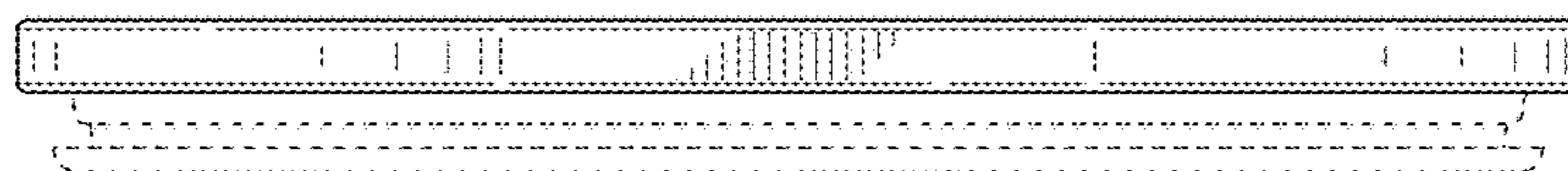

FIG. 16

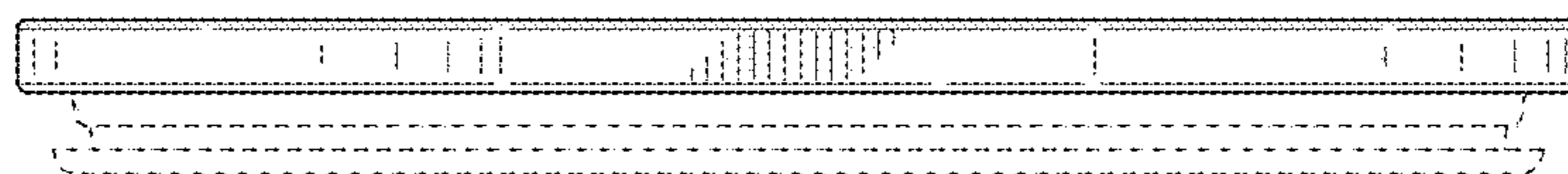

FIG. 17

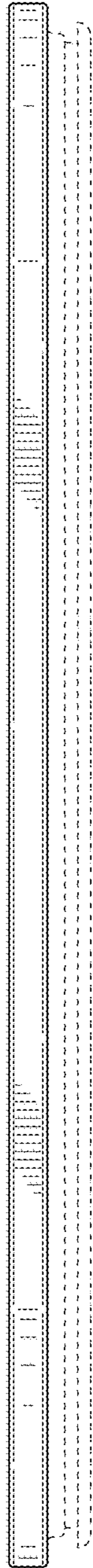

FIG. 18

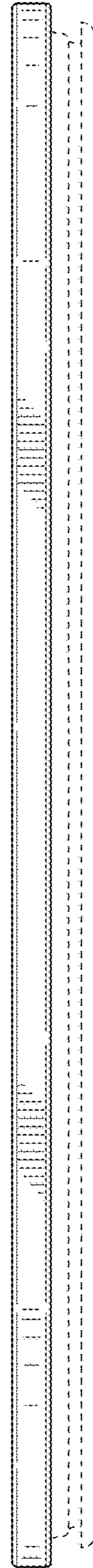

FIG. 19

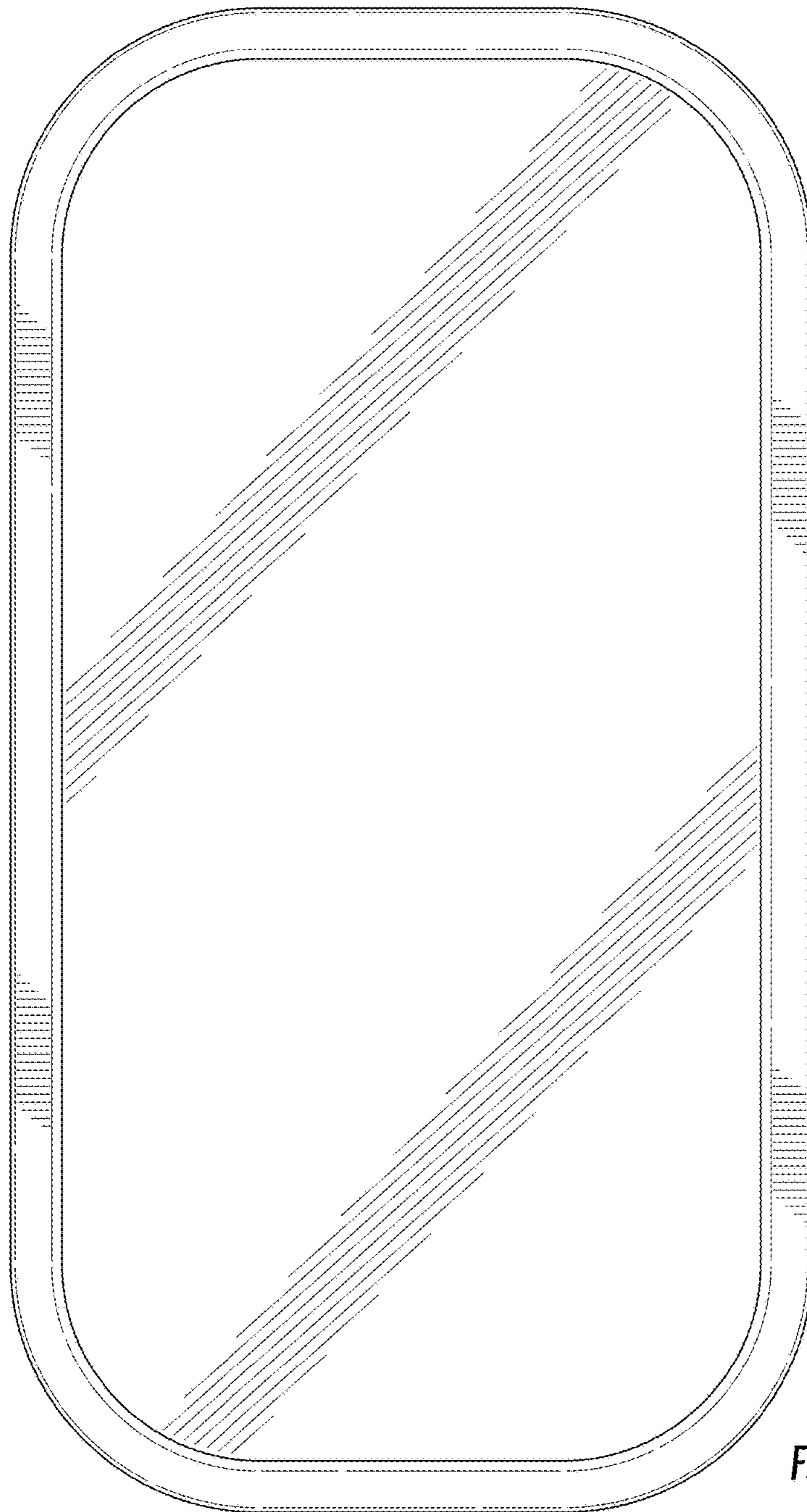

FIG. 20

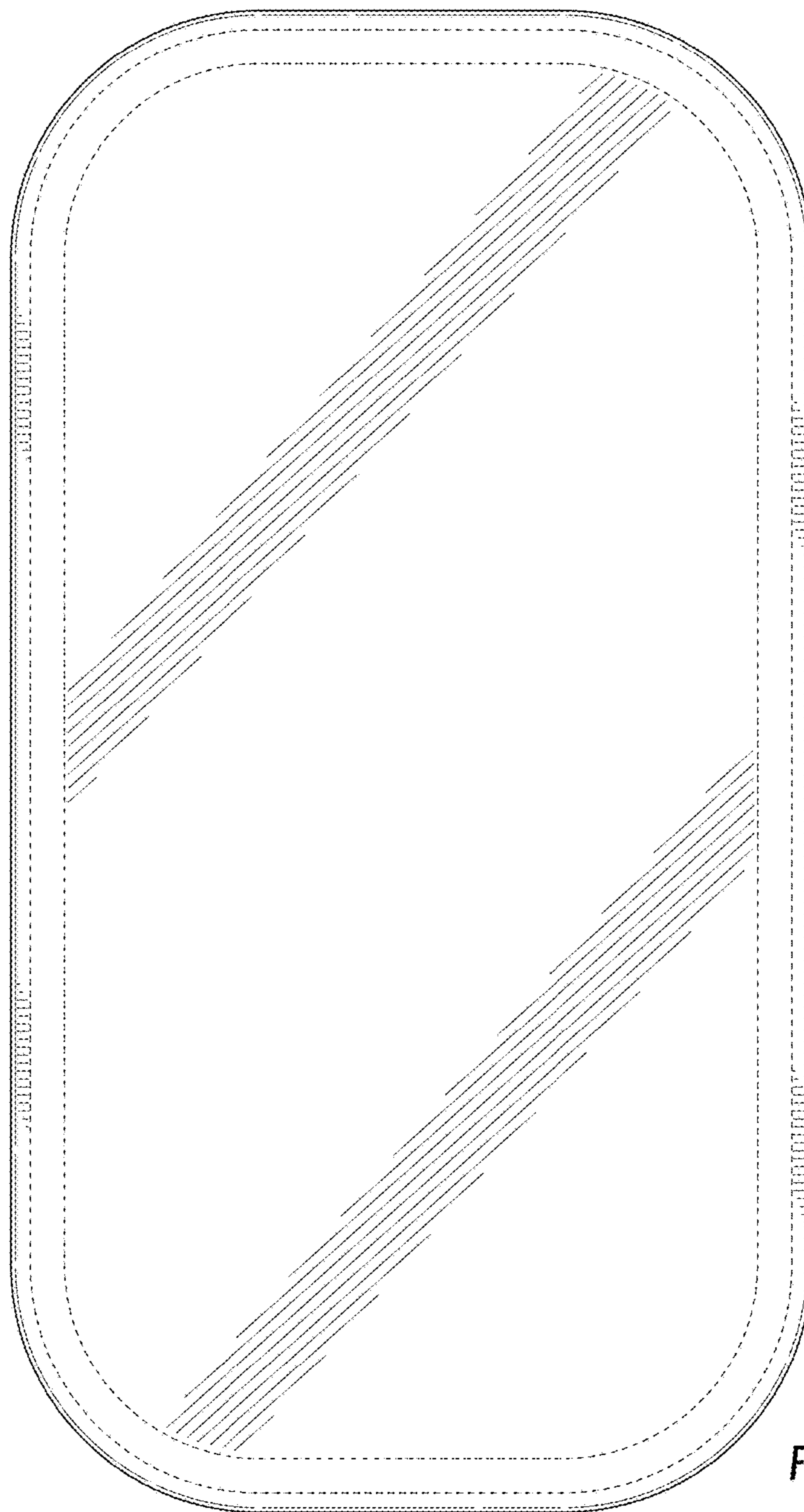

FIG. 21