



US00D867030S

(12) **United States Design Patent** (10) **Patent No.:** **US D867,030 S**
Gelman (45) **Date of Patent:** **** Nov. 19, 2019**

(54) **VANITY**

(71) Applicant: **E&T HORIZONS LIMITED LIABILITY COMPANY**, Melbourne, FL (US)

(72) Inventor: **Eric Gelman**, Melbourne, FL (US)

(73) Assignee: **E&T HORIZONS LIMITED LIABILITY COMPANY**, Melbourne, FL (US)

(**) Term: **15 Years**

(21) Appl. No.: **29/657,874**

(22) Filed: **Jul. 26, 2018**

(51) **LOC (12) Cl.** **06-04**

(52) **U.S. Cl.**
USPC **D6/657**

(58) **Field of Classification Search**
USPC D23/286, 308; D6/653.1, 657, 659-661, D6/663, 666, 671, 691.3, 709, 661.3, 668, D6/688.21; D25/48.7, 48.3
CPC A47B 2200/12; A47B 88/40; A47B 77/06; E01C 1/33
See application file for complete search history.

(56) **References Cited**

U.S. PATENT DOCUMENTS

D471,378 S *	3/2003	Lenger	D6/657
D474,045 S *	5/2003	Berry, Jr.	D6/668.2
D532,626 S *	11/2006	McDiarmid	D6/671.1
D559,404 S *	1/2008	Chen	D25/48.3
D559,584 S *	1/2008	Zambelli	D6/657
D560,395 S *	1/2008	Mayer	D23/286
D620,727 S *	8/2010	LeTourneau	D23/286
D634,948 S *	3/2011	Lewis	D6/691.8
D731,827 S *	6/2015	Thorne	D6/691.3
D747,900 S *	1/2016	Sheppard	D6/661
D754,455 S *	4/2016	Healy	D6/657

OTHER PUBLICATIONS

83" Black Granite Counter Top Bathroom Double Sink Vanity Lavatory Cabinet, https://www.ebay.com/itm/83-Black-Granite-Counter-Top-Bathroom-Double-Sink-Vanity-Lavatory-Cabinet-266BG-/271785017842?_trksid=p2349526.m4383.l44720.c10&nordt=true&rt=nc&orig_cvip=true (Year: 2019).*

* cited by examiner

Primary Examiner — Robert A Delehanty

(74) *Attorney, Agent, or Firm* — Mark Malek; Widerman Malek, PL

(57) **CLAIM**

The ornamental design for a vanity, as shown and described.

DESCRIPTION

FIG. 1 is a front perspective view of a vanity according to the present invention.
FIG. 2 is a front elevation view of the vanity illustrated in FIG. 1.
FIG. 3 is a rear elevation view of the vanity illustrated in FIG. 1.
FIG. 4 is a side elevation view of the vanity illustrated in FIG. 1.
FIG. 5 is another side elevation view of the vanity illustrated in FIG. 1.
FIG. 6 is a top plan view of the vanity illustrated in FIG. 1.
FIG. 7 is a bottom plan view of the vanity illustrated in FIG. 1; and,
FIG. 8 is a rear perspective view of the vanity illustrated in FIG. 1.
The broken lines depict interior portions of the vanity that form no part of the claimed invention.

1 Claim, 5 Drawing Sheets

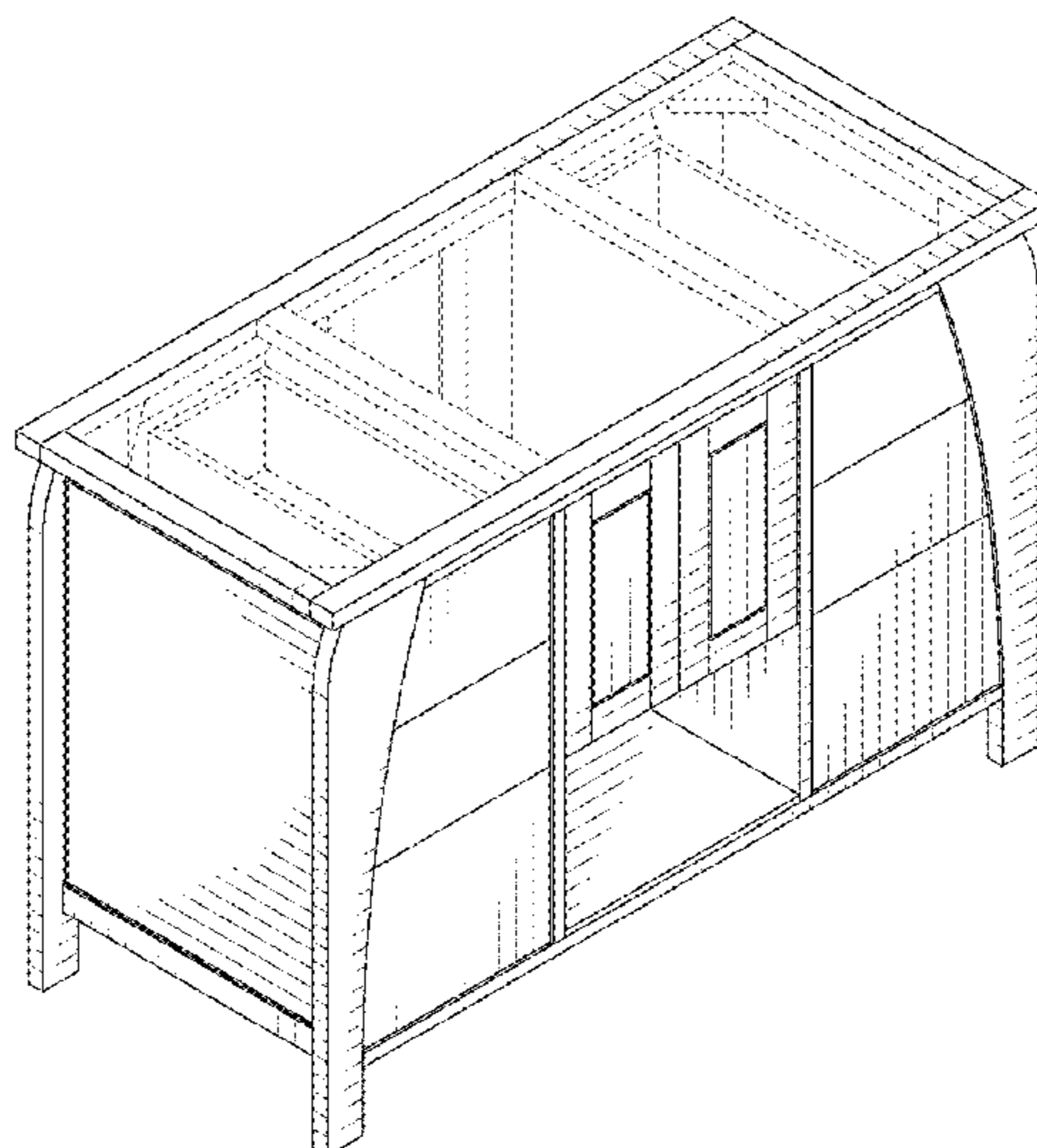

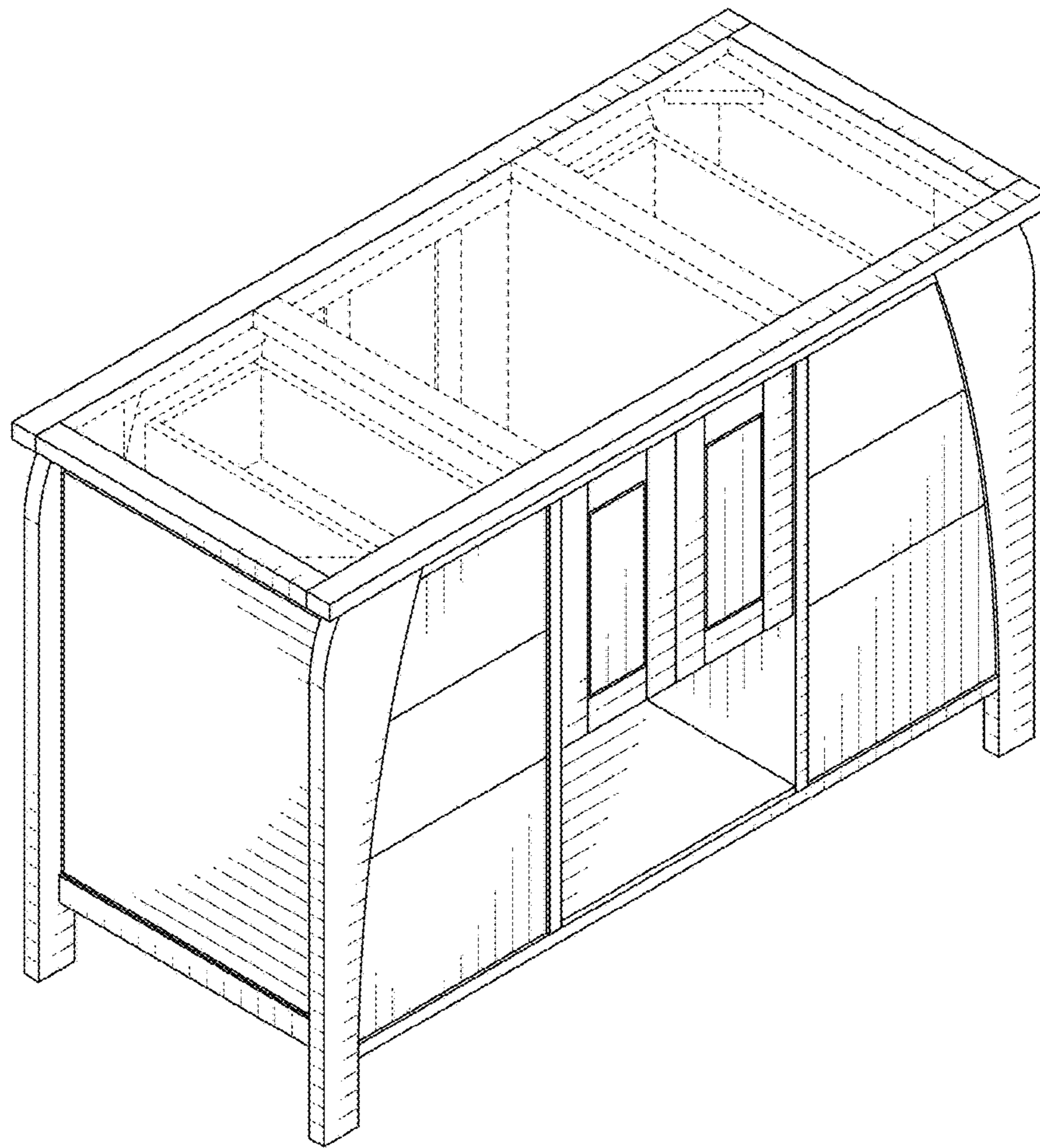

FIG. 1

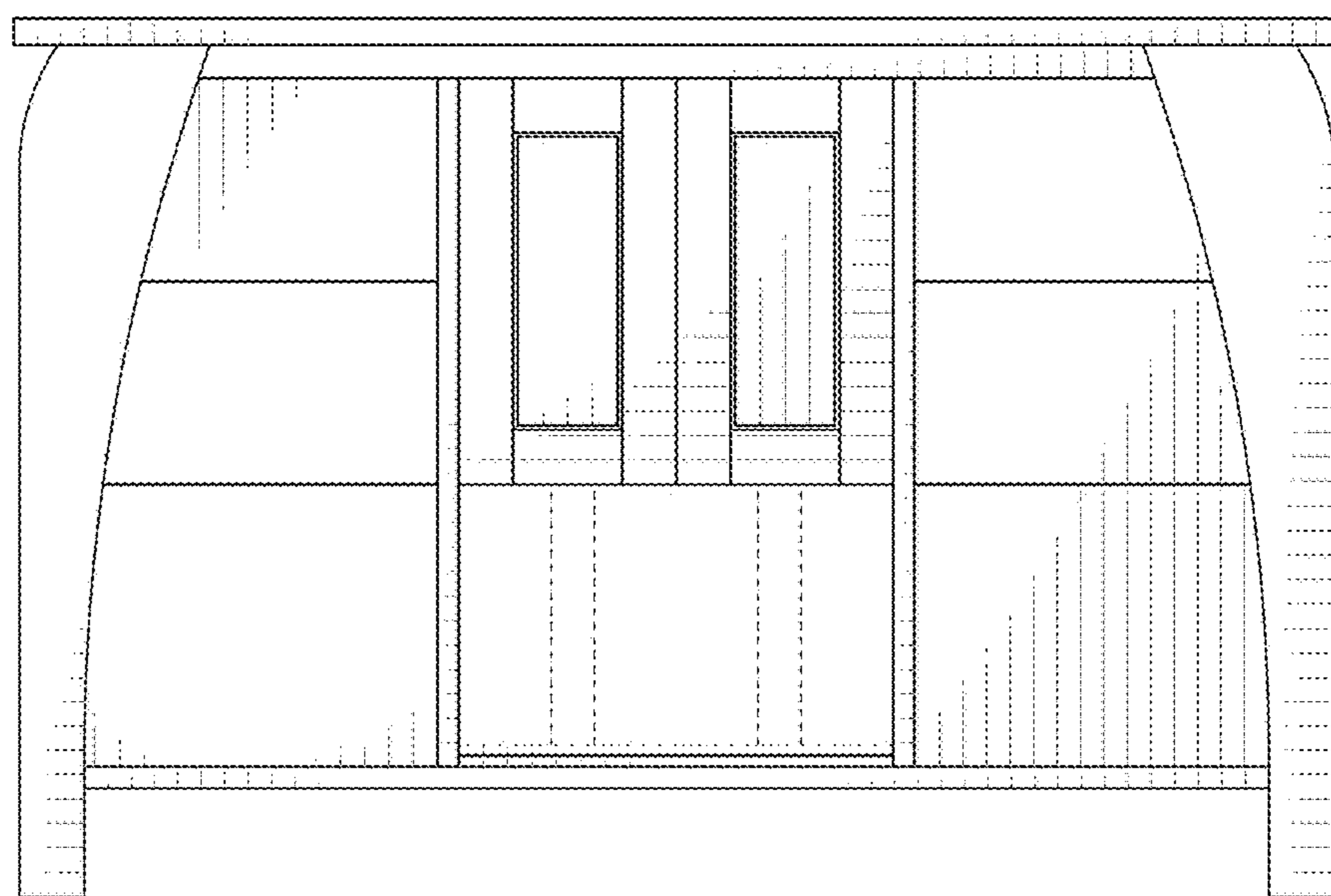

FIG. 2

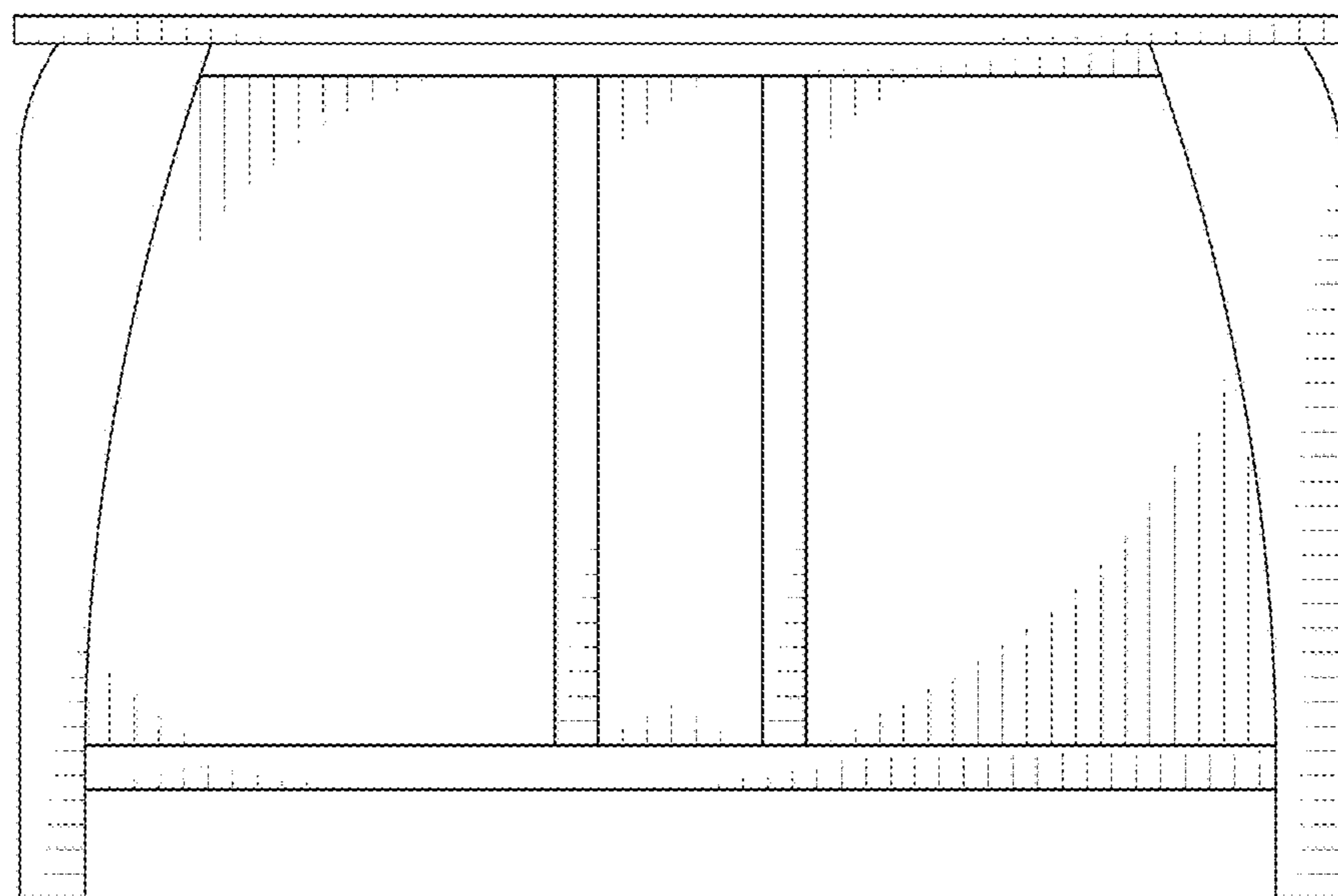

FIG. 3

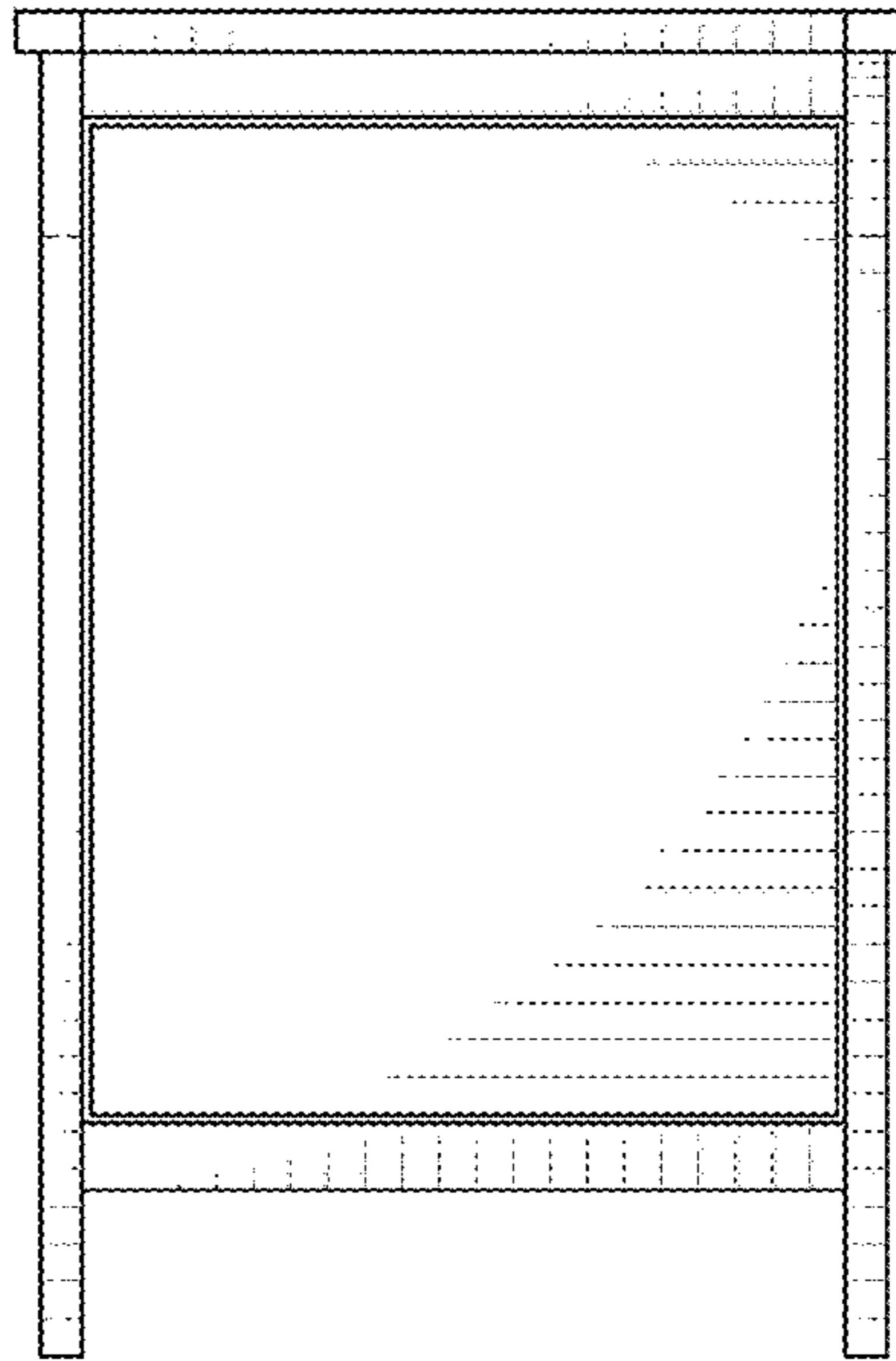

FIG. 4

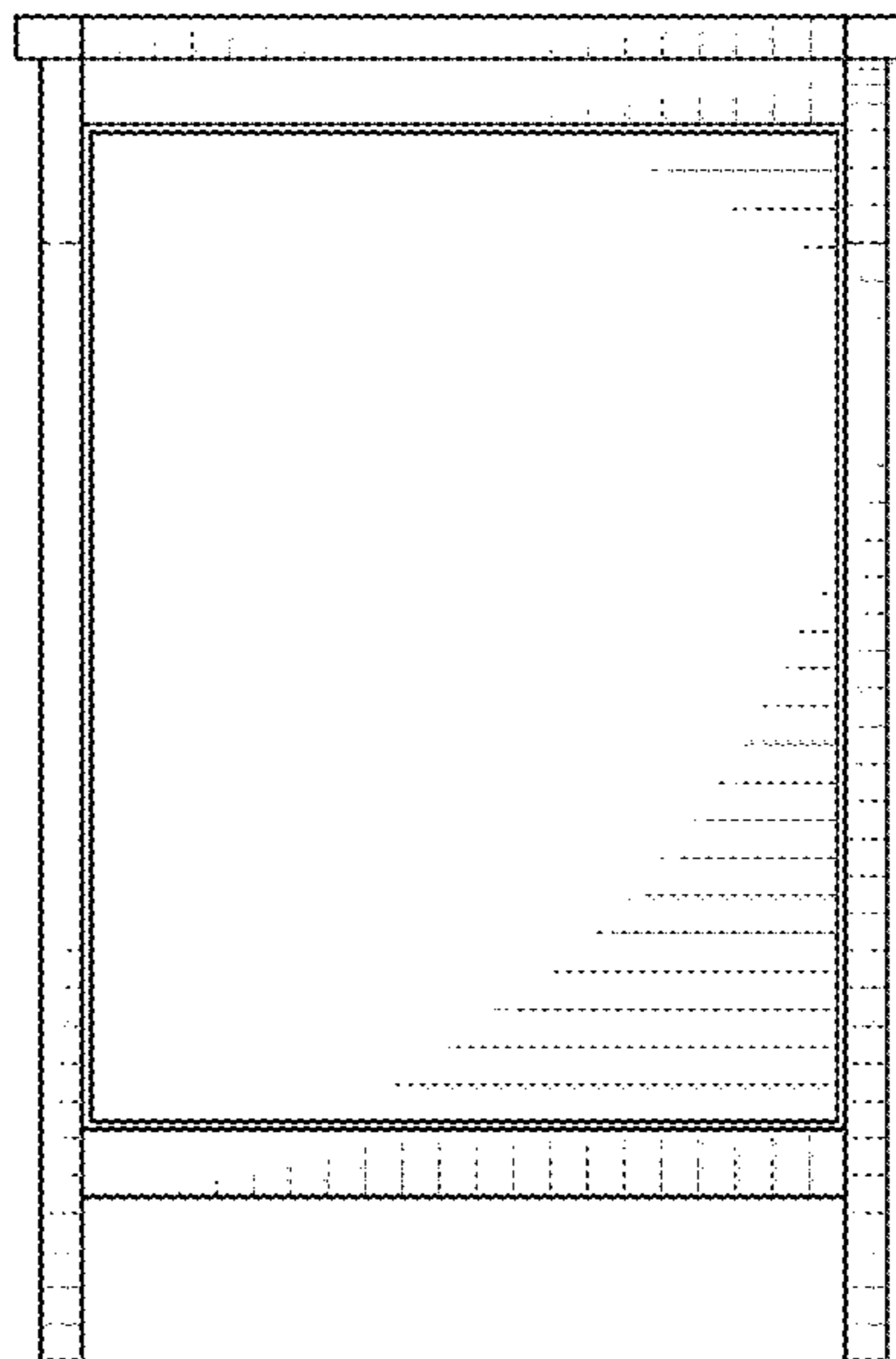

FIG. 5

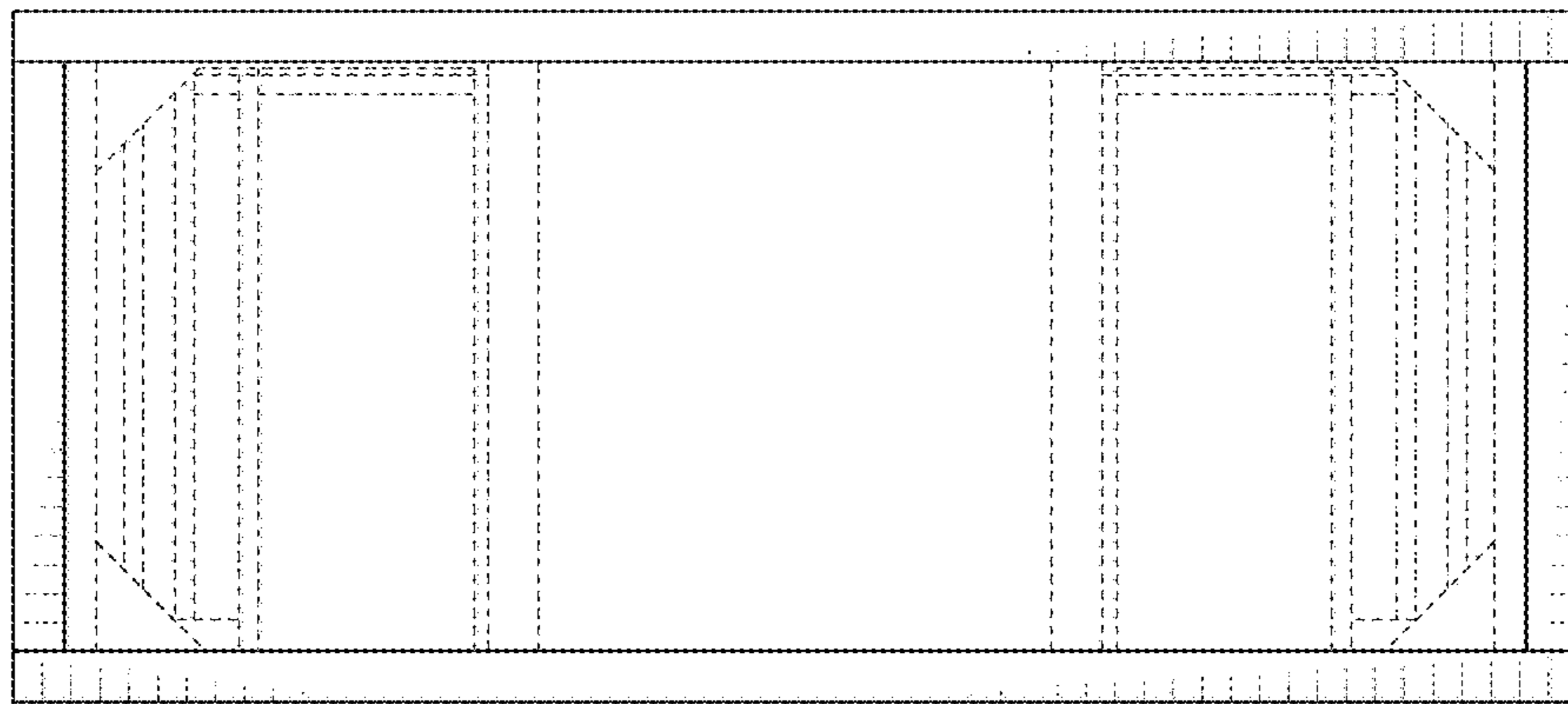

FIG. 6

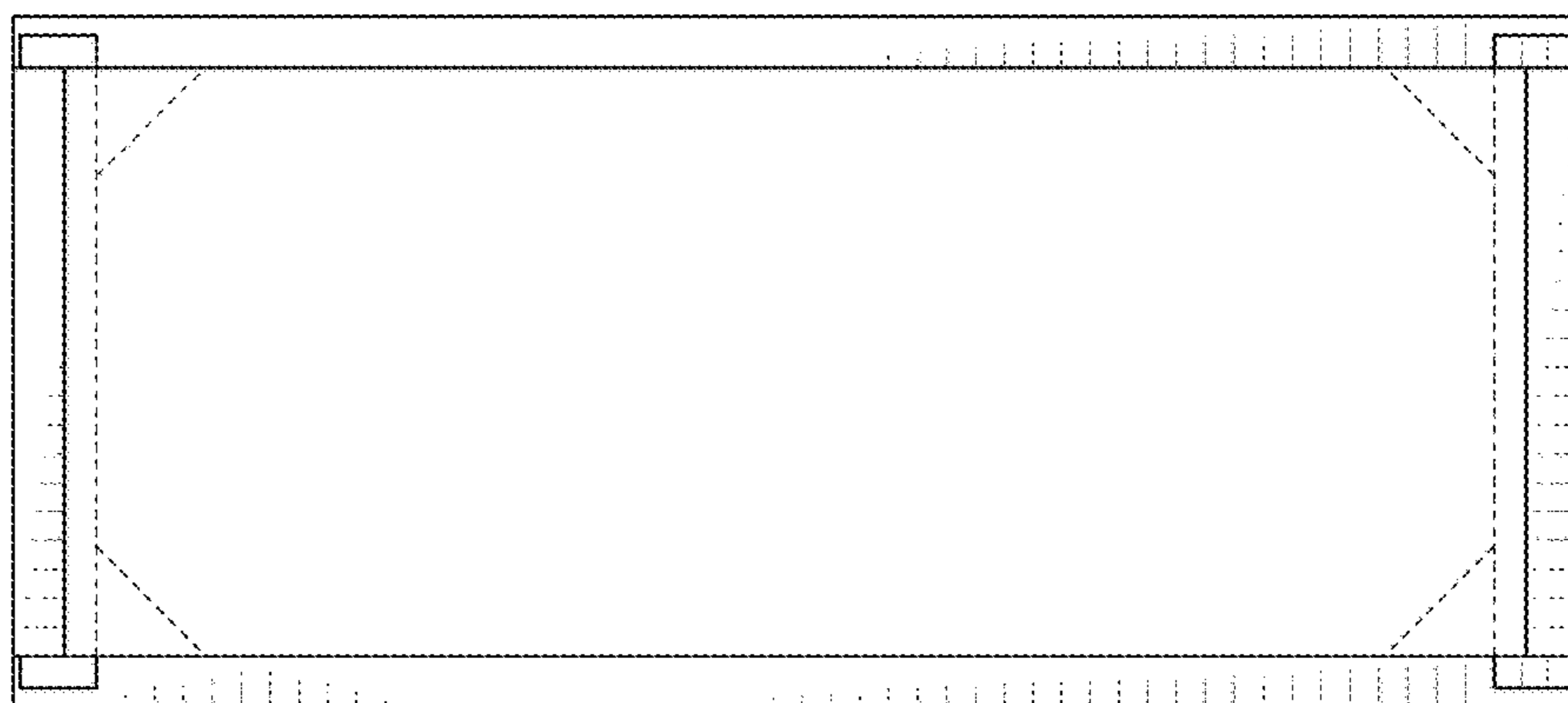

FIG. 7

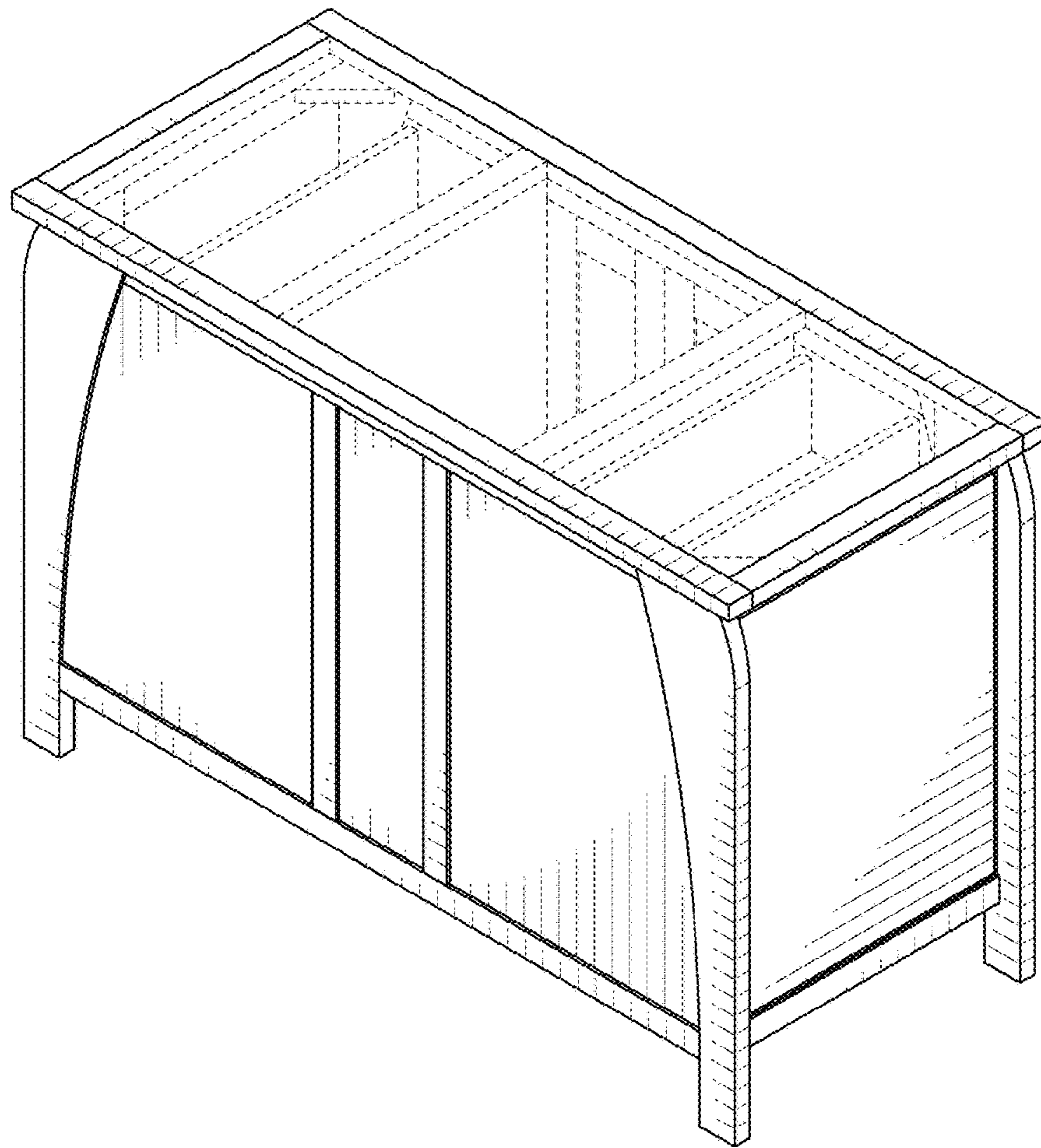

FIG. 8