

US00D867017S

(12) **United States Design Patent** (10) **Patent No.:** **US D867,017 S**
Altizer (45) **Date of Patent:** **** Nov. 19, 2019**

(54) **PEGBOARD**

Primary Examiner — Wan Laymon
Assistant Examiner — Mark Booker

(71) Applicant: **Edsal Manufacturing Company, Inc.**,
Chicago, IL (US)

(74) *Attorney, Agent, or Firm* — Wood Herron & Evans
LLP

(72) Inventor: **John Altizer**, Chicago, IL (US)

(73) Assignee: **Edsal Manufacturing Company, Inc.**,
Chicago, IL (US)

(57) **CLAIM**

(**) Term: **15 Years**

The ornamental design for a pegboard, as shown and
described.

(21) Appl. No.: **29/657,432**

DESCRIPTION

(22) Filed: **Jul. 23, 2018**

(51) **LOC (12) Cl.** **06-04**

(52) **U.S. Cl.**
USPC **D6/553**

(58) **Field of Classification Search**
USPC D6/553, 566, 571, 572; D25/58, 138,
D25/153, 156, 152, 155; 211/87.01,
211/90.04; 248/220.31; D8/21–28
CPC .. A47K 1/09; F16B 2/06; F16B 21/02; F16M
13/02; F16M 11/041; F16M 13/00
See application file for complete search history.

FIG. 1 is a front elevation view of pegboard showing
environmental structure according to the present invention;
FIG. 2 is a detail view of the claimed portion of the view of
FIG. 1;
FIG. 3 is a rear view thereof;
FIG. 4 is a front-top-left perspective view thereof;
FIG. 5 is a rear-top-left perspective view thereof;
FIG. 6 is top plan view thereof;
FIG. 7 is a bottom plan view thereof;
FIG. 8 is a cross-sectional view taken along line 8-8 of FIG.
2;
FIG. 9 is a right side elevation view thereof; and,
FIG. 10 is a left side elevation view thereof.
The broken lines shown in FIG. 1 represent portions of the
pegboard that form no part of the claimed design. The
broken dot-dash lines in the figures represents the boundary
of the claim. Neither the portions of the invention shown in
broken lines and the boundary of the claim, nor the broken
dash lines themselves, form any part of the claimed inven-
tion.

(56) **References Cited**

U.S. PATENT DOCUMENTS

D455,221 S *	4/2002	Smith	D25/152
D495,067 S *	8/2004	Winig	D25/138
D512,254 S *	12/2005	Ottens	D6/553
D573,828 S *	7/2008	Clokey	D6/553
D678,701 S *	3/2013	Hansen	D6/561
D771,409 S *	11/2016	Wall	D6/553
D773,196 S *	12/2016	Vanderheyden	D6/300

* cited by examiner

1 Claim, 7 Drawing Sheets

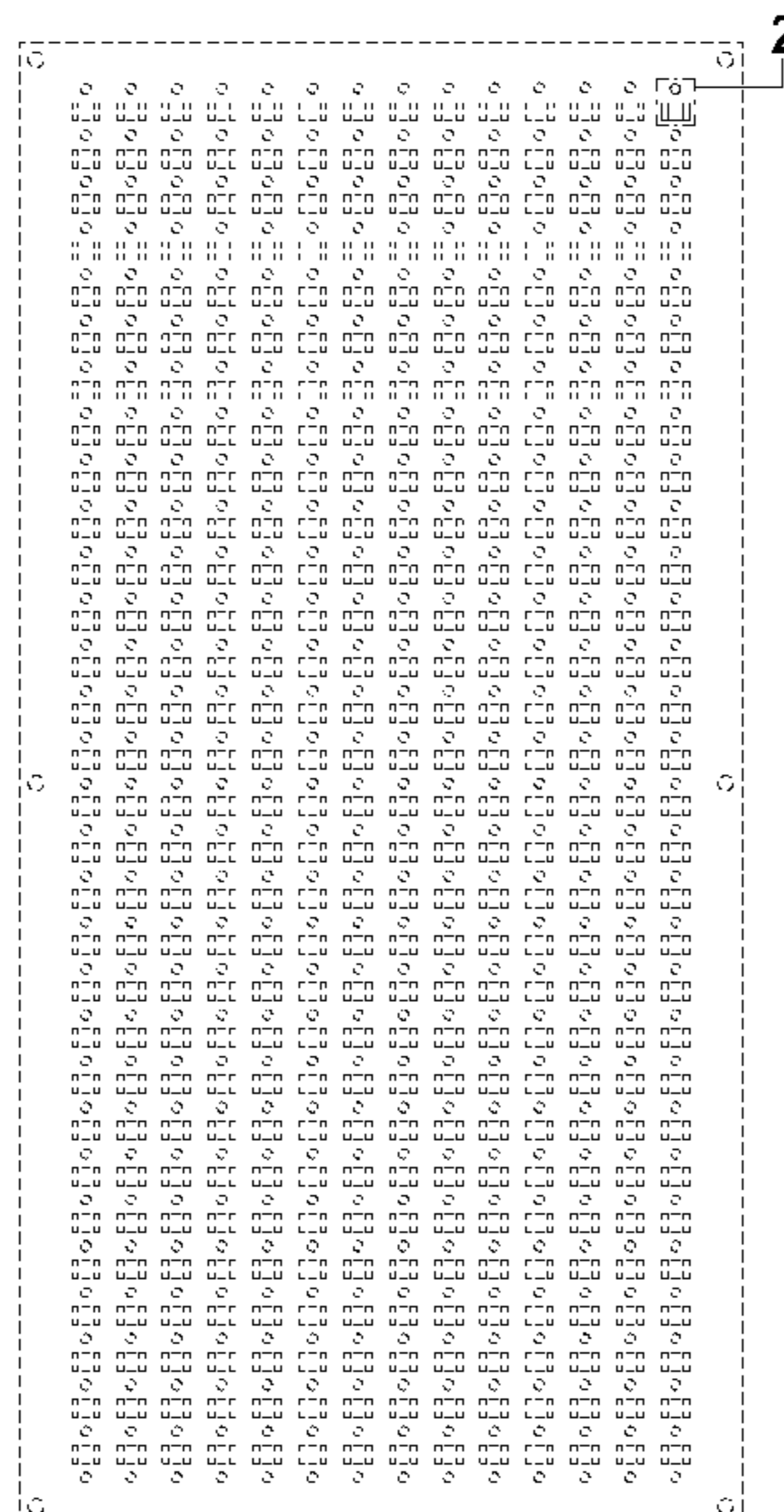

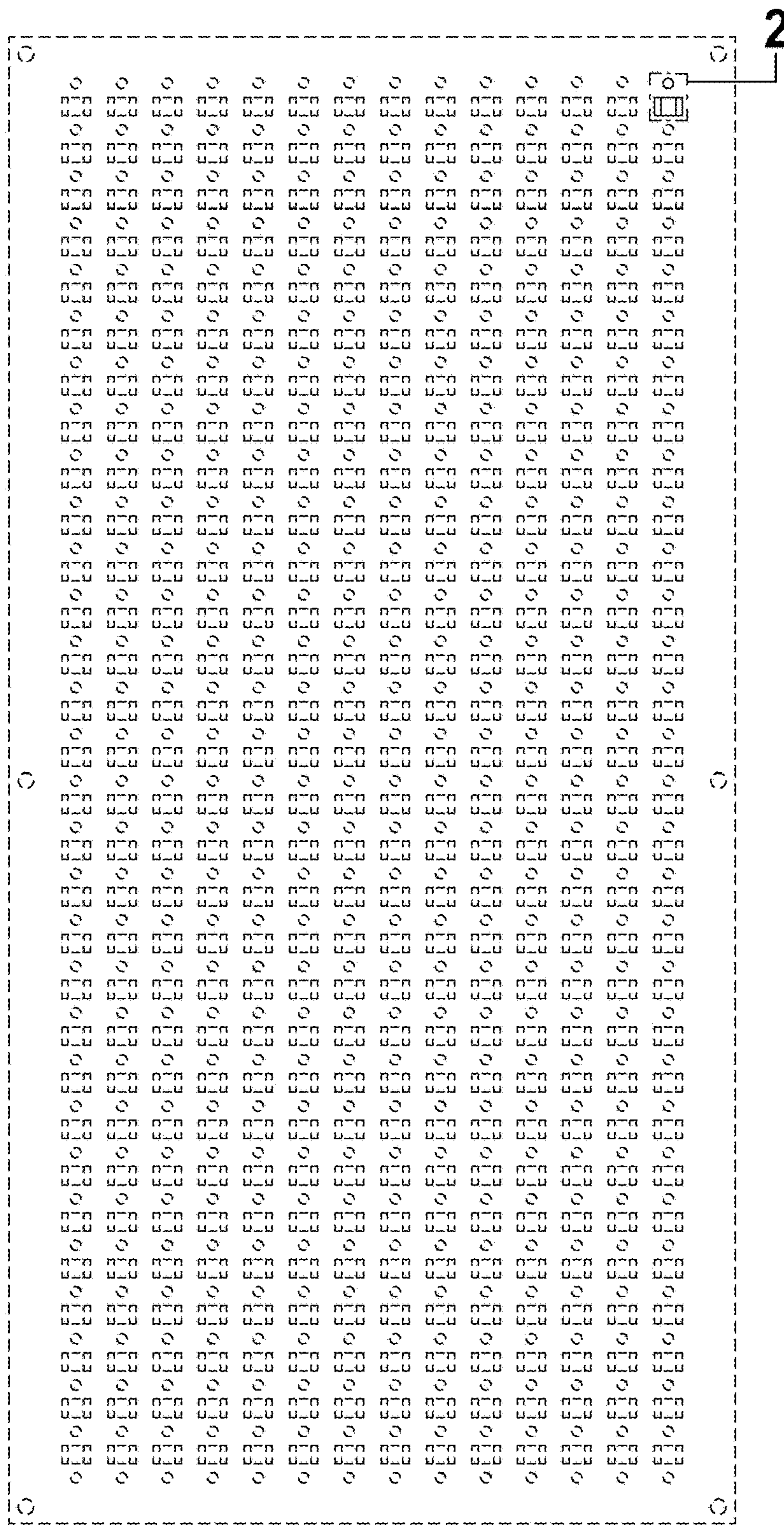

FIG. 1

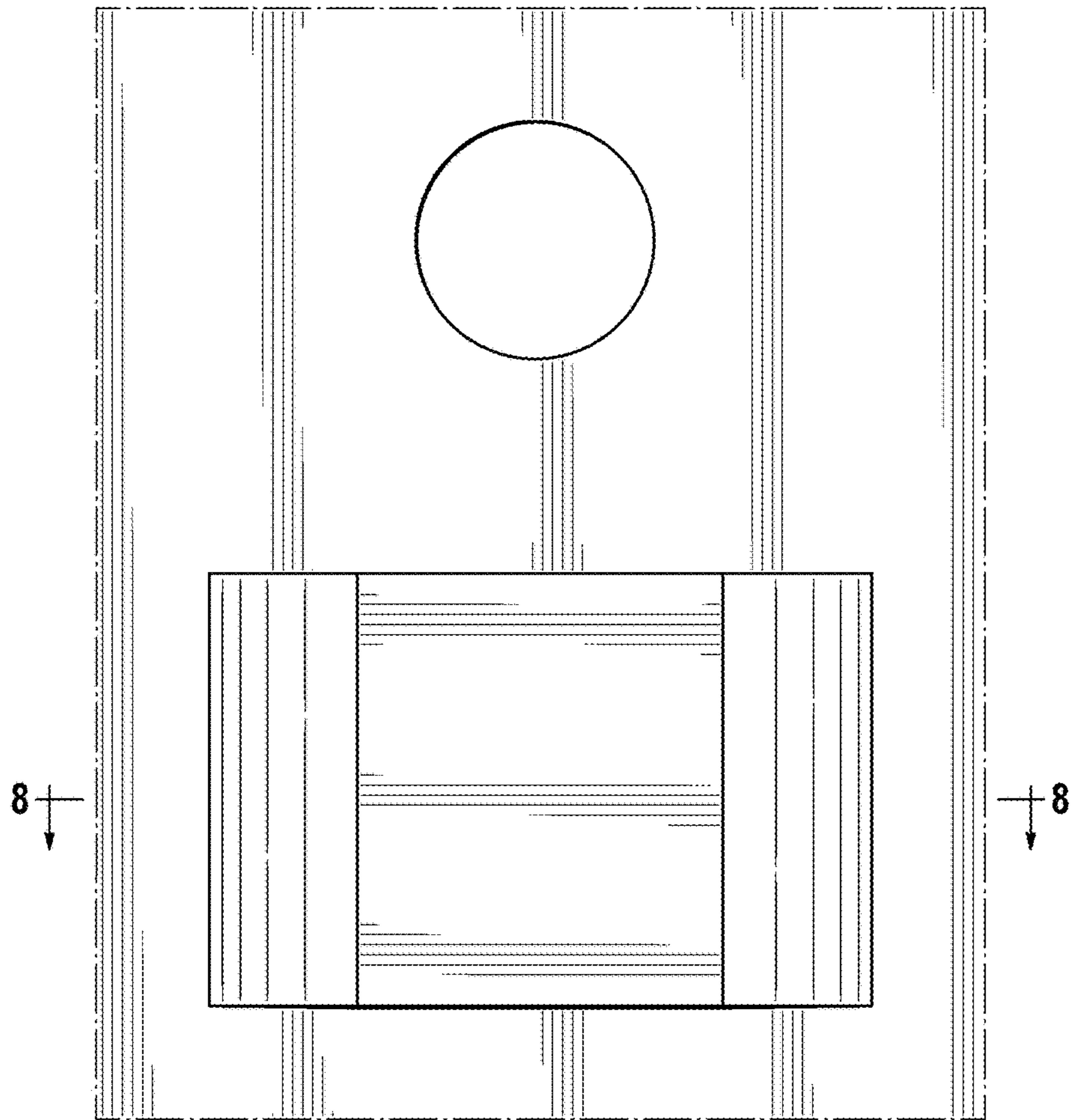

FIG. 2

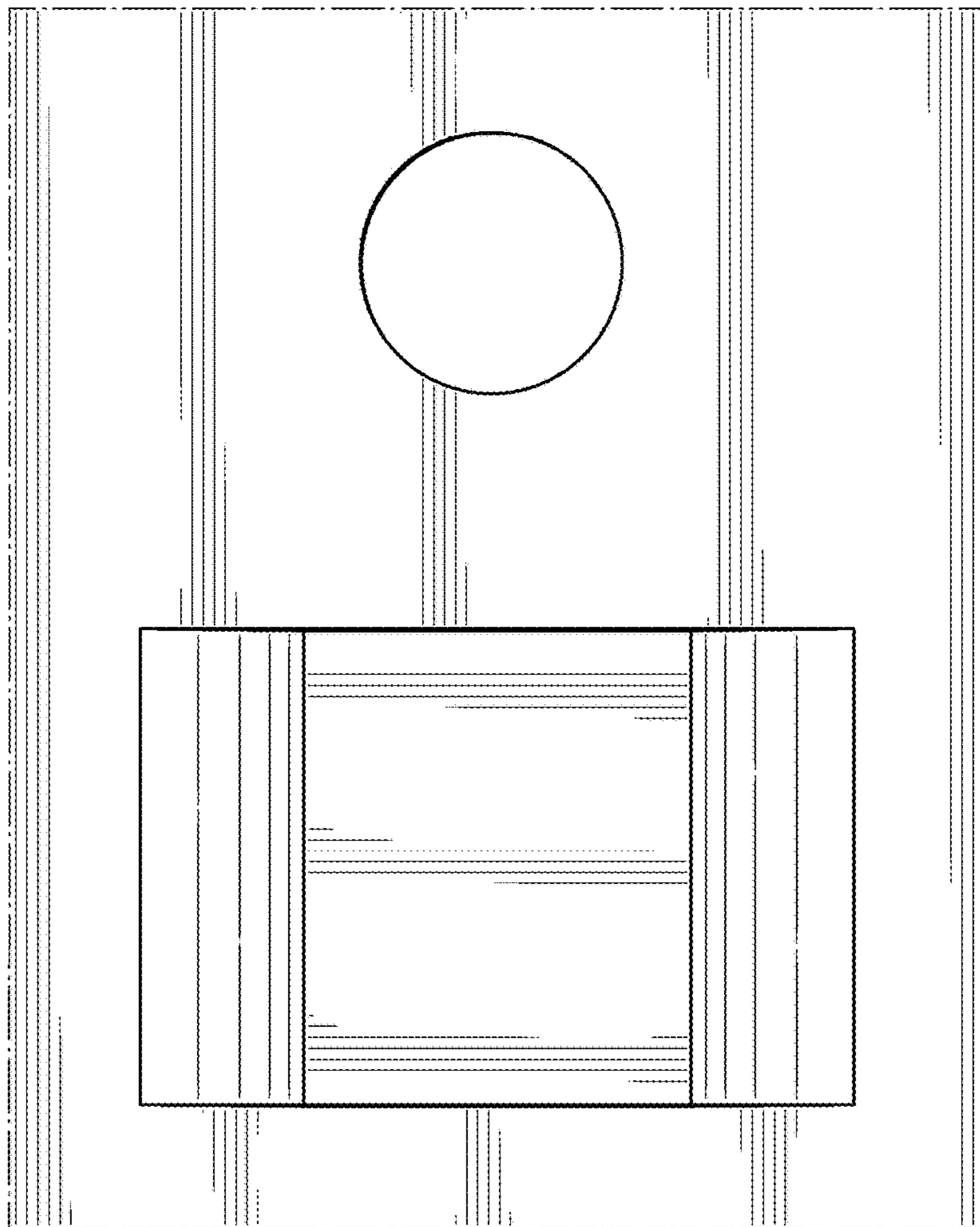

FIG. 3

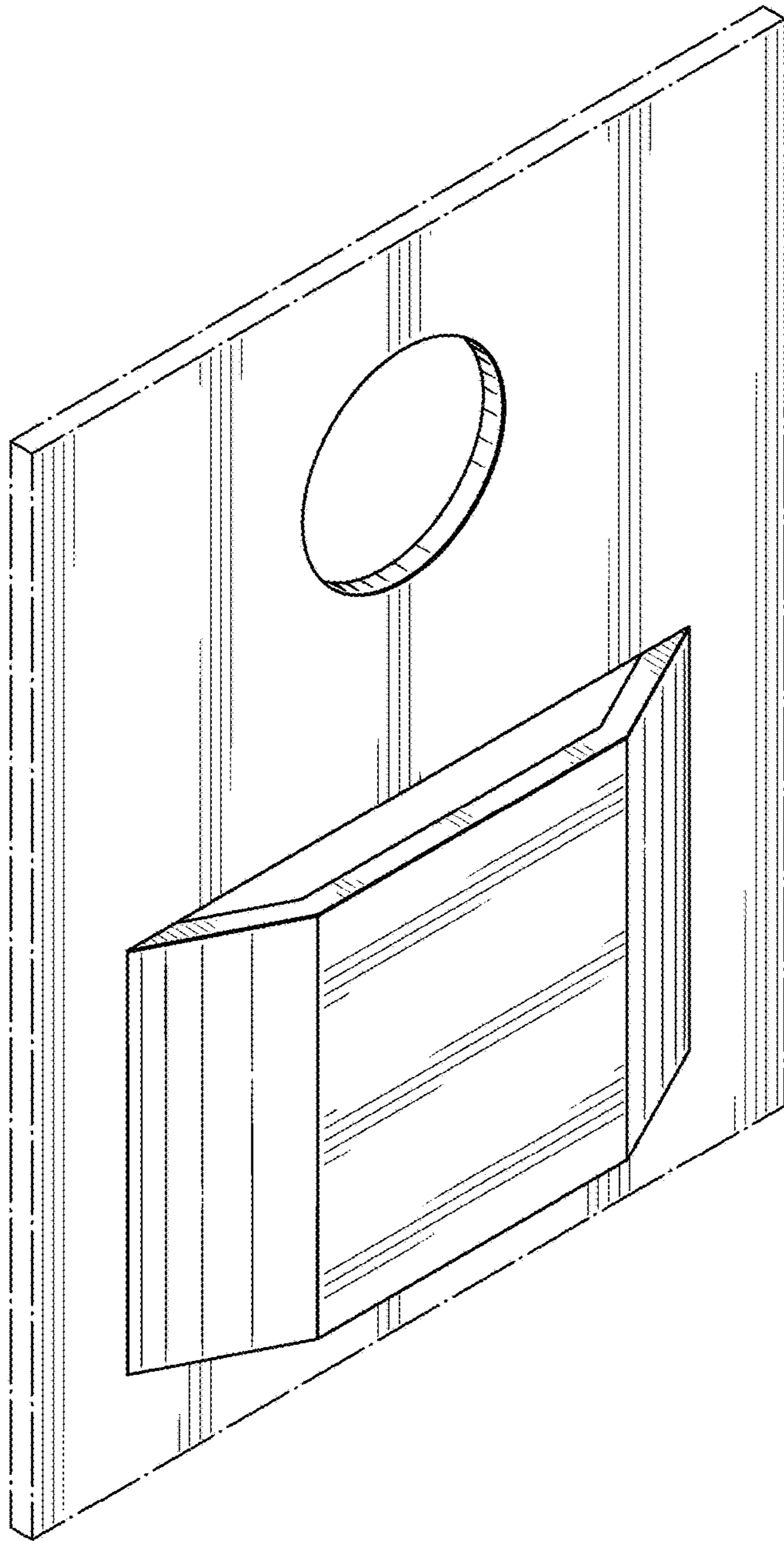

FIG. 4

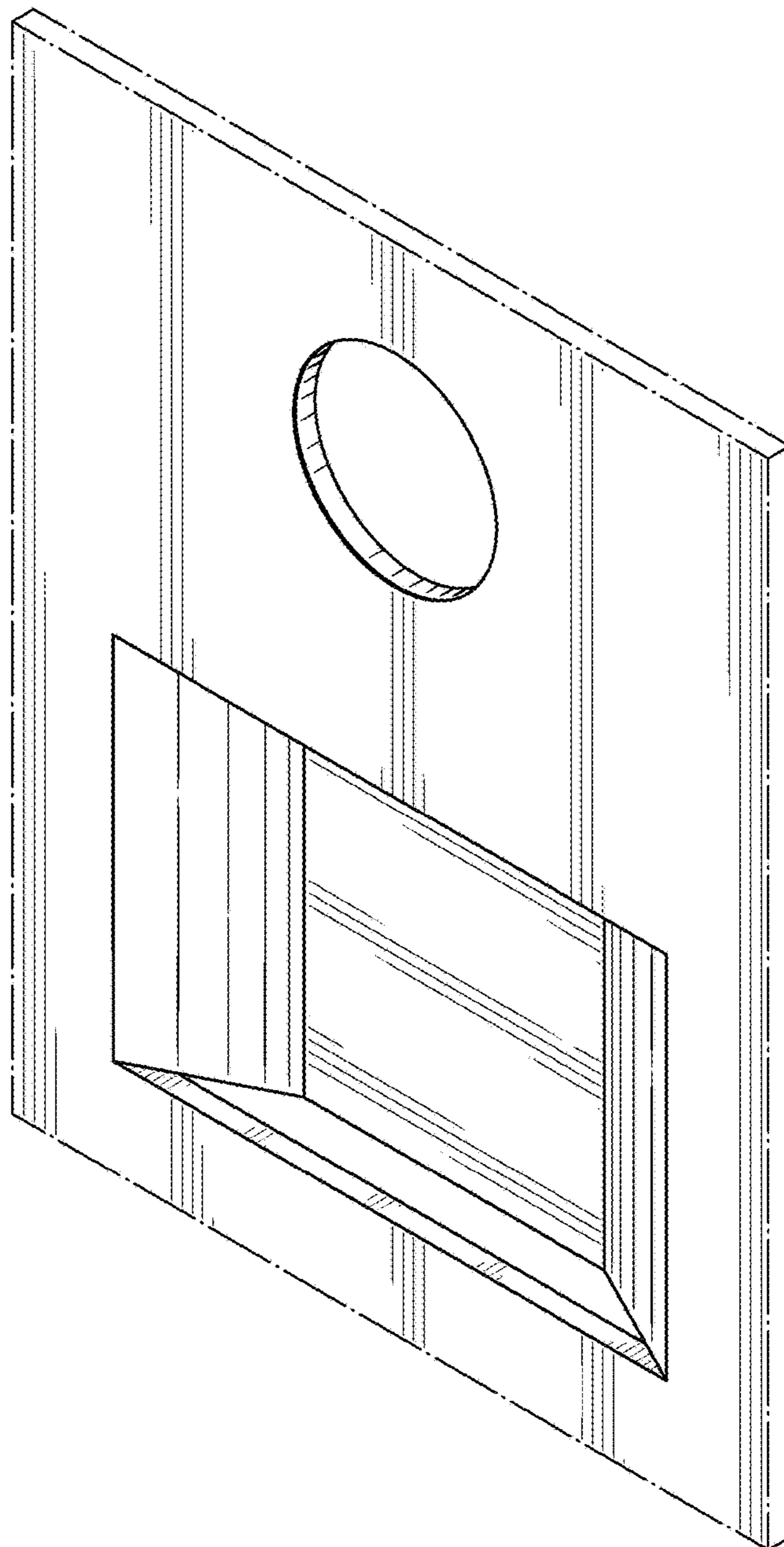

FIG. 5

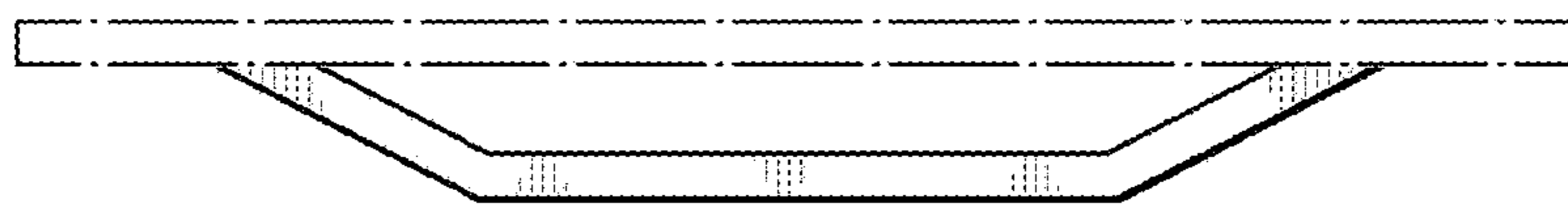

FIG. 6



FIG. 7

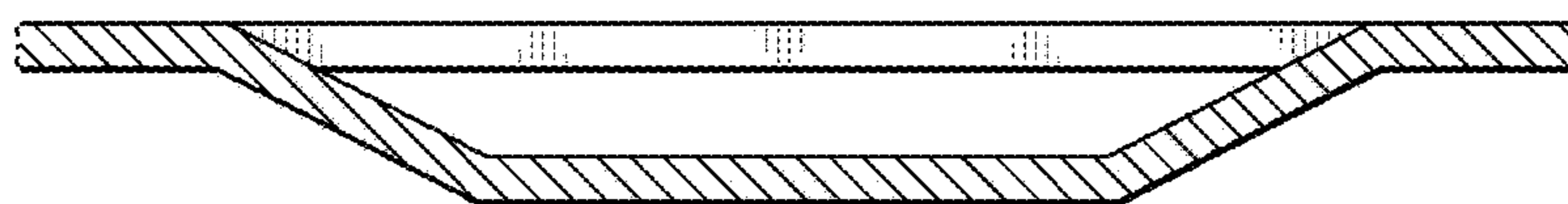

FIG. 8

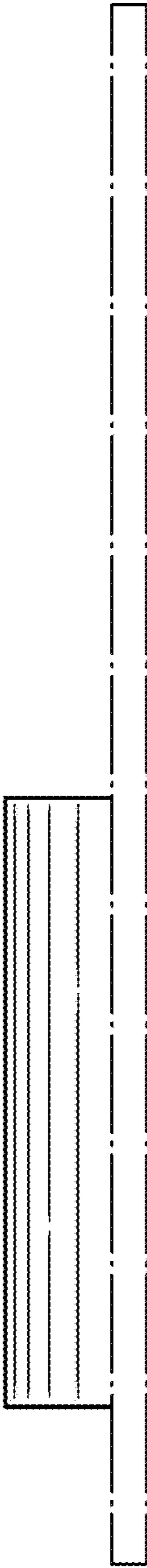

FIG. 9



FIG. 10