



US00D867016S

(12) **United States Design Patent**
Brogan et al.

(10) **Patent No.:** **US D867,016 S**

(45) **Date of Patent:** **** Nov. 19, 2019**

(54) **WALL MOUNTED KEY HOLDER**

(71) Applicants: **John Brogan**, Chalfont, PA (US); **Scott Soley**, Souderton, PA (US)

(72) Inventors: **John Brogan**, Chalfont, PA (US); **Scott Soley**, Souderton, PA (US)

(**) Term: **15 Years**

(21) Appl. No.: **29/618,045**

(22) Filed: **Sep. 19, 2017**

(51) **LOC (12) Cl.** **06-04**

(52) **U.S. Cl.**
USPC **D6/553**

(58) **Field of Classification Search**
USPC D6/553, 315, 320, 512, 513, 566, 567,
D6/569; D8/349, 354, 367, 372;
D14/168, 188, 497; D17/14, 20
CPC A47B 96/067; B25H 3/04; A47C 17/84;
Y10T 70/8676; Y10T 24/1379; Y10T
24/45026; A47G 29/10; A44D 2203/00
See application file for complete search history.

(56) **References Cited**

U.S. PATENT DOCUMENTS

D505,288 S *	5/2005	Bankston	D6/553
D616,687 S *	6/2010	Yuzyk	D6/553
D779,585 S *	2/2017	Dedrick	D17/20
D789,706 S *	6/2017	Brogan	D6/553
D810,464 S *	2/2018	Brogan	D6/553

* cited by examiner

Primary Examiner — Wan Laymon
Assistant Examiner — Mark Booker

(57) **CLAIM**

The ornamental design for a wall mounted key holder, as shown and described.

DESCRIPTION

FIG. 1 is a front right perspective view of an embodiment of our design.

FIG. 2 is a front elevational view of the embodiment shown in FIG. 1.

FIG. 3 is a top elevational view of the embodiment shown in FIG. 1.

FIG. 4 is a bottom elevational view of the embodiment shown in FIG. 1.

FIG. 5 is a left elevational view of the embodiment shown in FIG. 1.

FIG. 6 is a right elevational view of the embodiment shown in FIG. 1.

FIG. 7 is back right perspective view of the embodiment shown in FIG. 1.

FIG. 8 is a front right perspective view of another embodiment of our design.

FIG. 9 is a front elevational view of the embodiment shown in FIG. 8.

FIG. 10 is a top elevational view of the embodiment shown in FIG. 8.

FIG. 11 is a bottom elevational view of the embodiment shown in FIG. 8.

FIG. 12 is a left elevational view of the embodiment shown in FIG. 8.

FIG. 13 is a right elevational view of the embodiment shown in FIG. 8; and,

FIG. 14 is a back right elevational view of the embodiment shown in FIG. 8.

The broken lines shown in the figures represent portions of the wall mounted key holder, that form no part of the claimed design.

The stippling and shading lines are to show contours and forms no part of the claimed design.

1 Claim, 10 Drawing Sheets

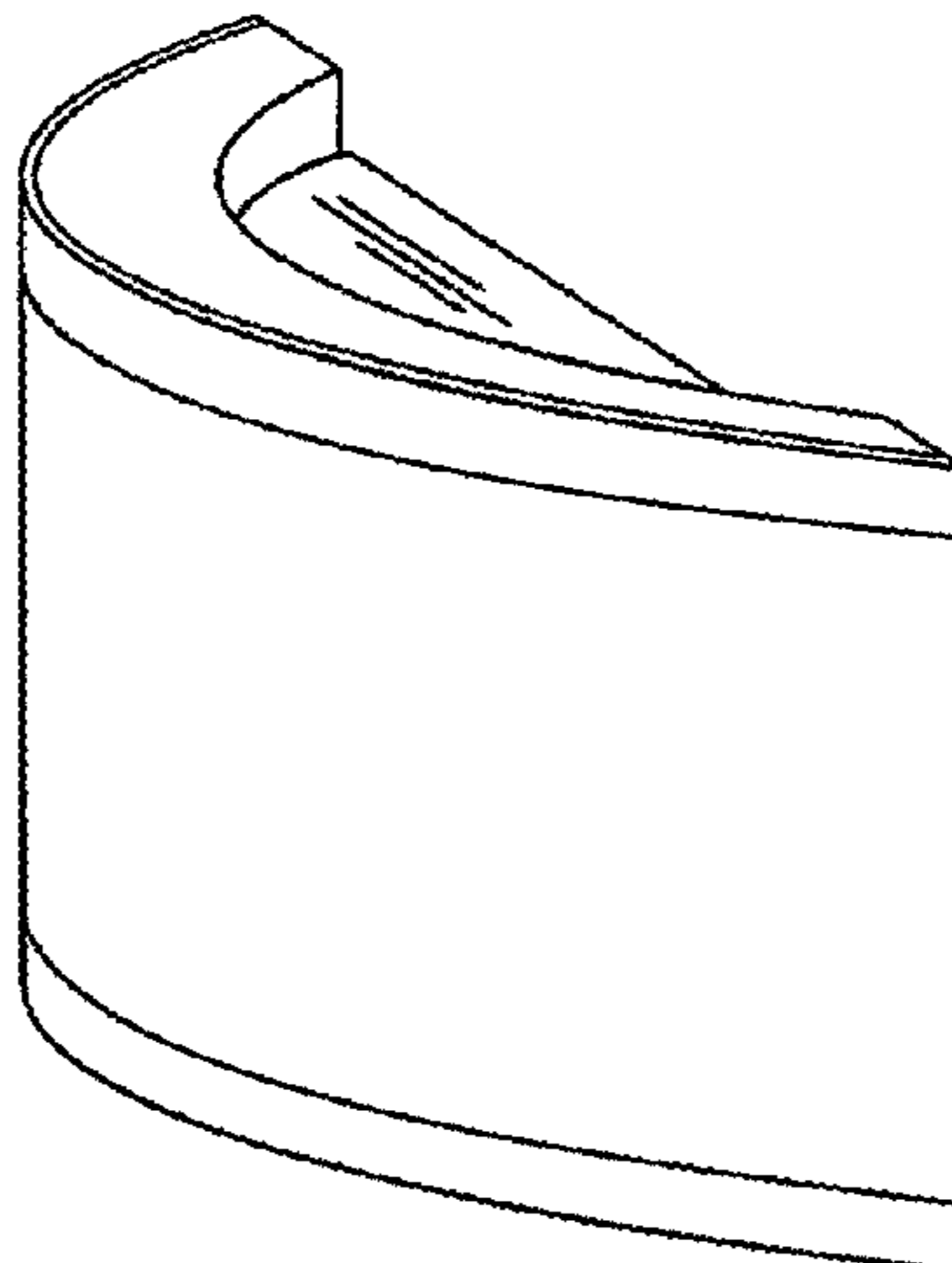

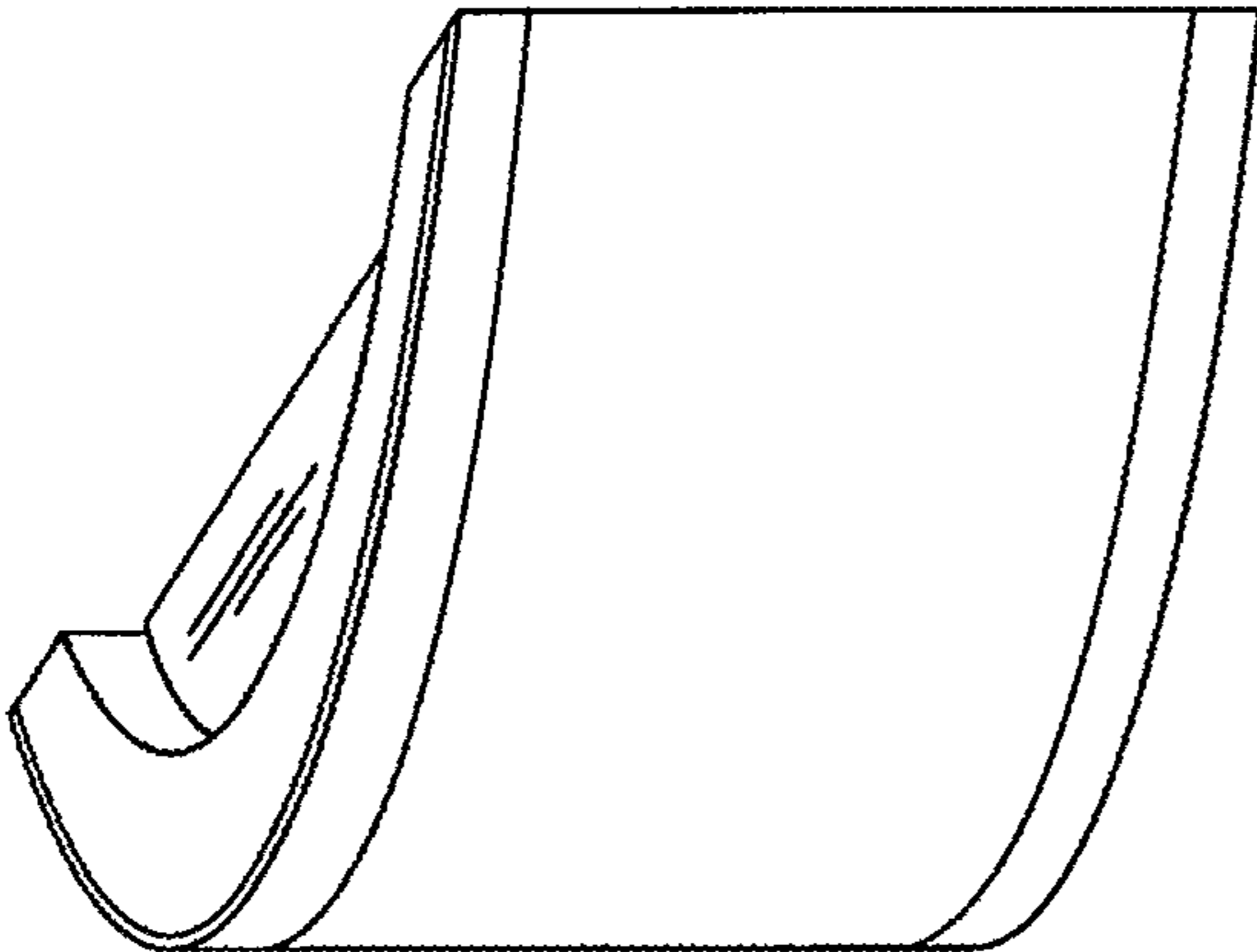

Fig. 1

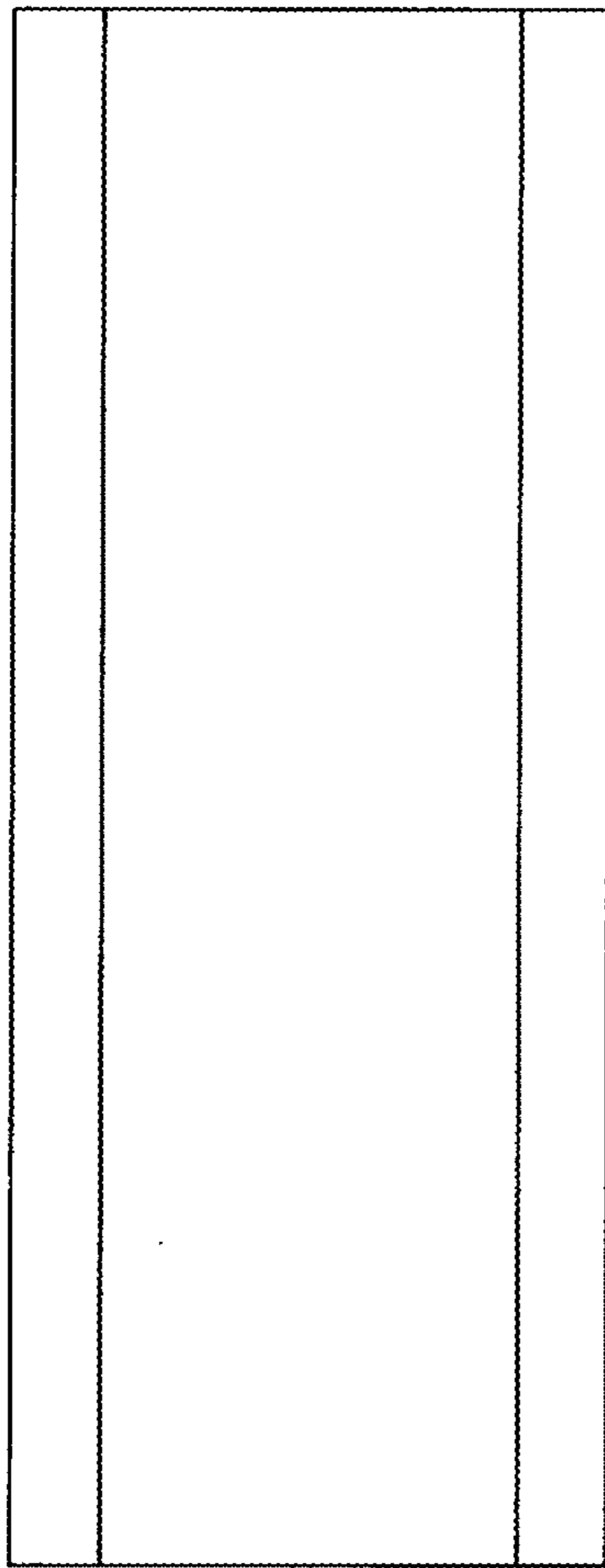

Fig. 2

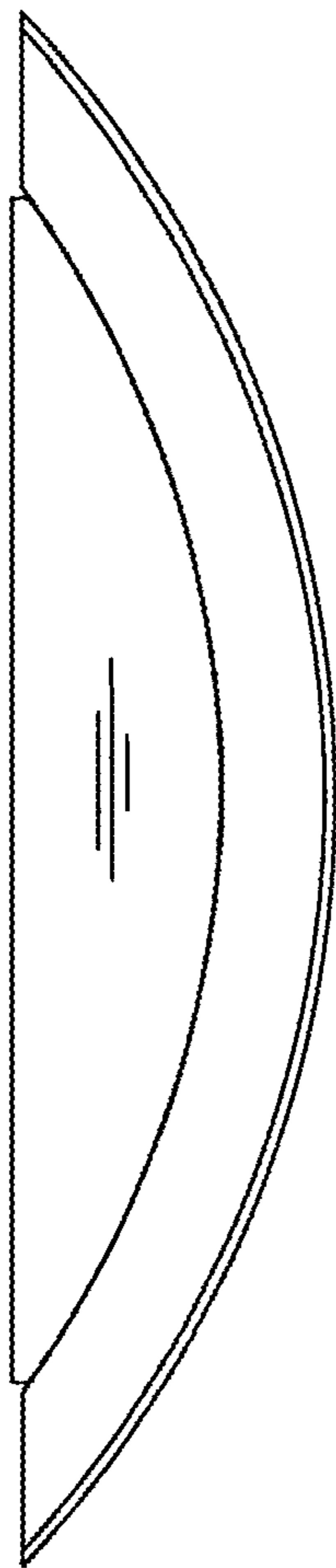

Fig. 3

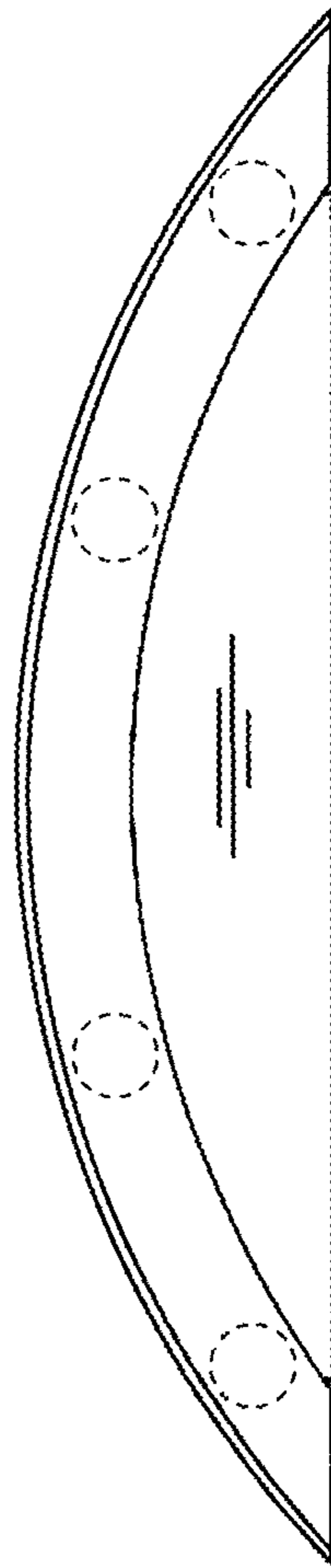

Fig. 4

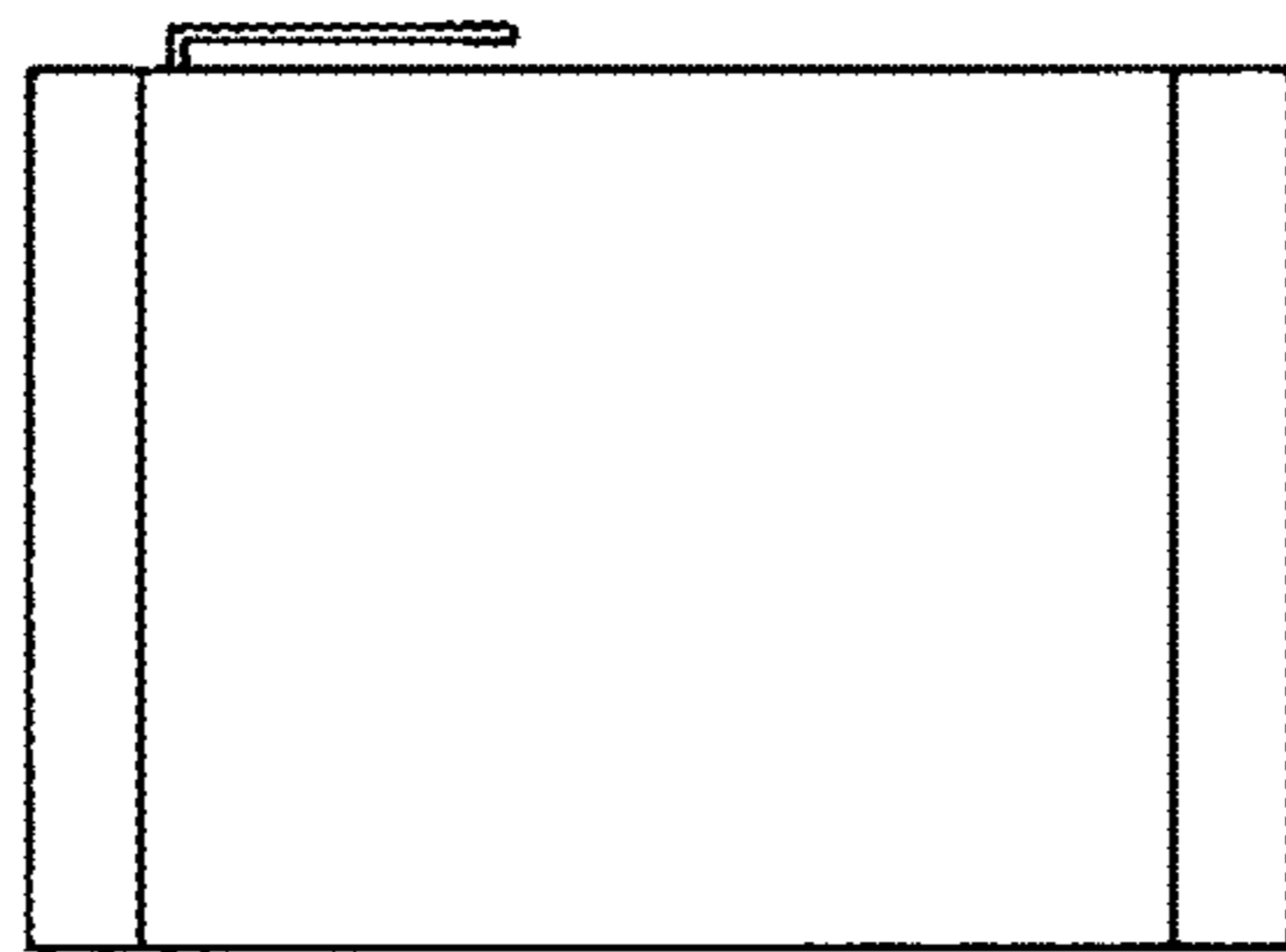

Fig. 6

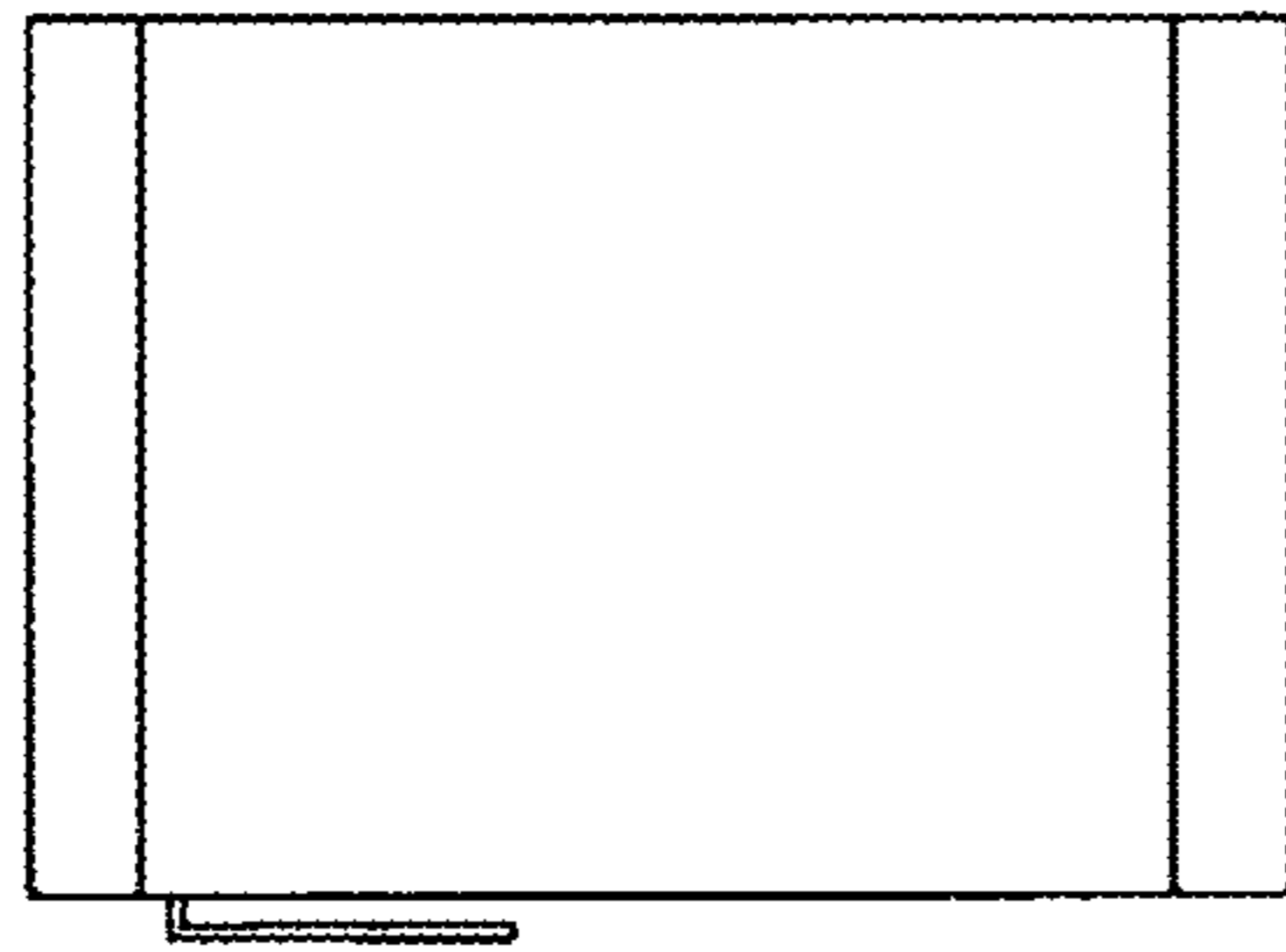

Fig. 5

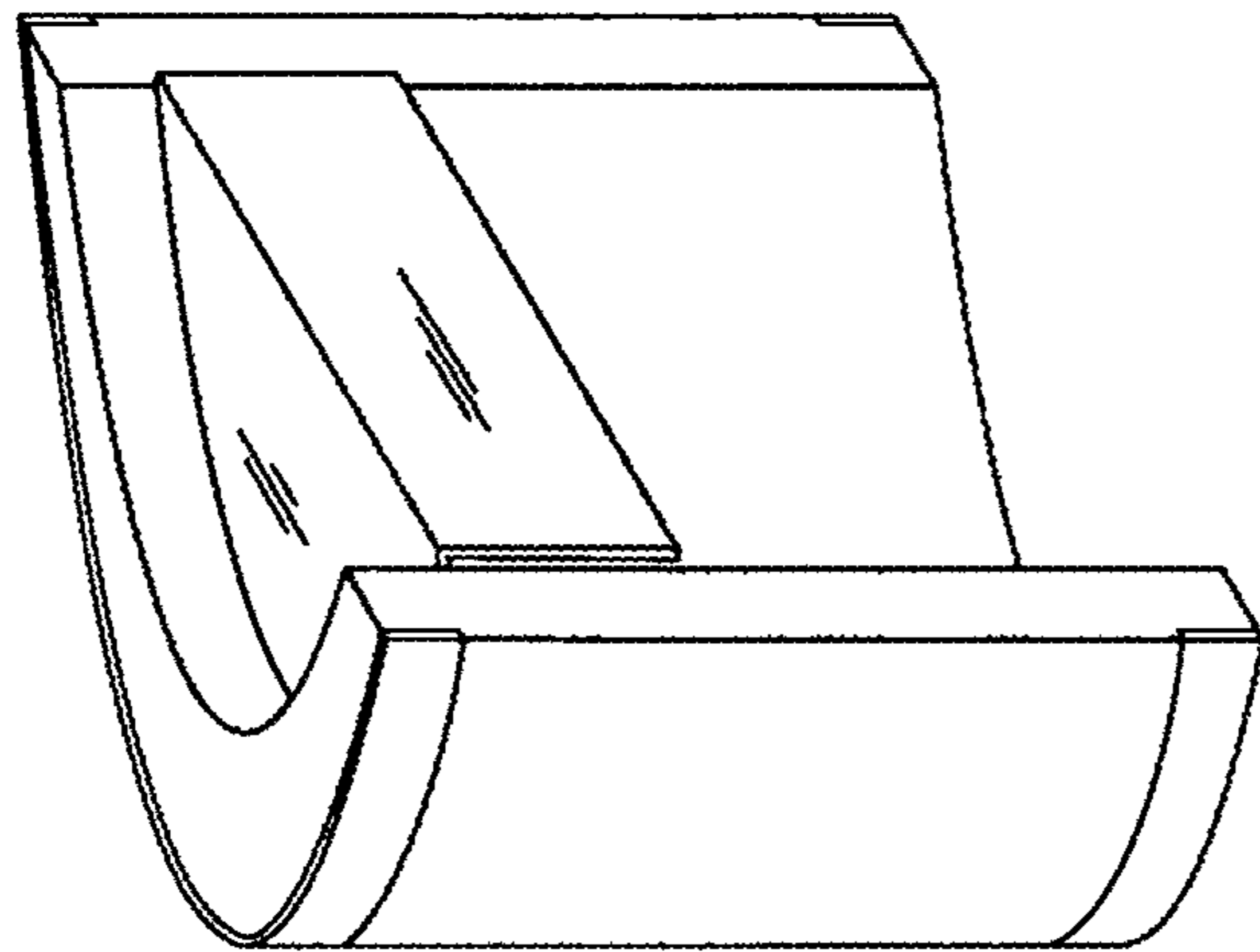

FIG. 7

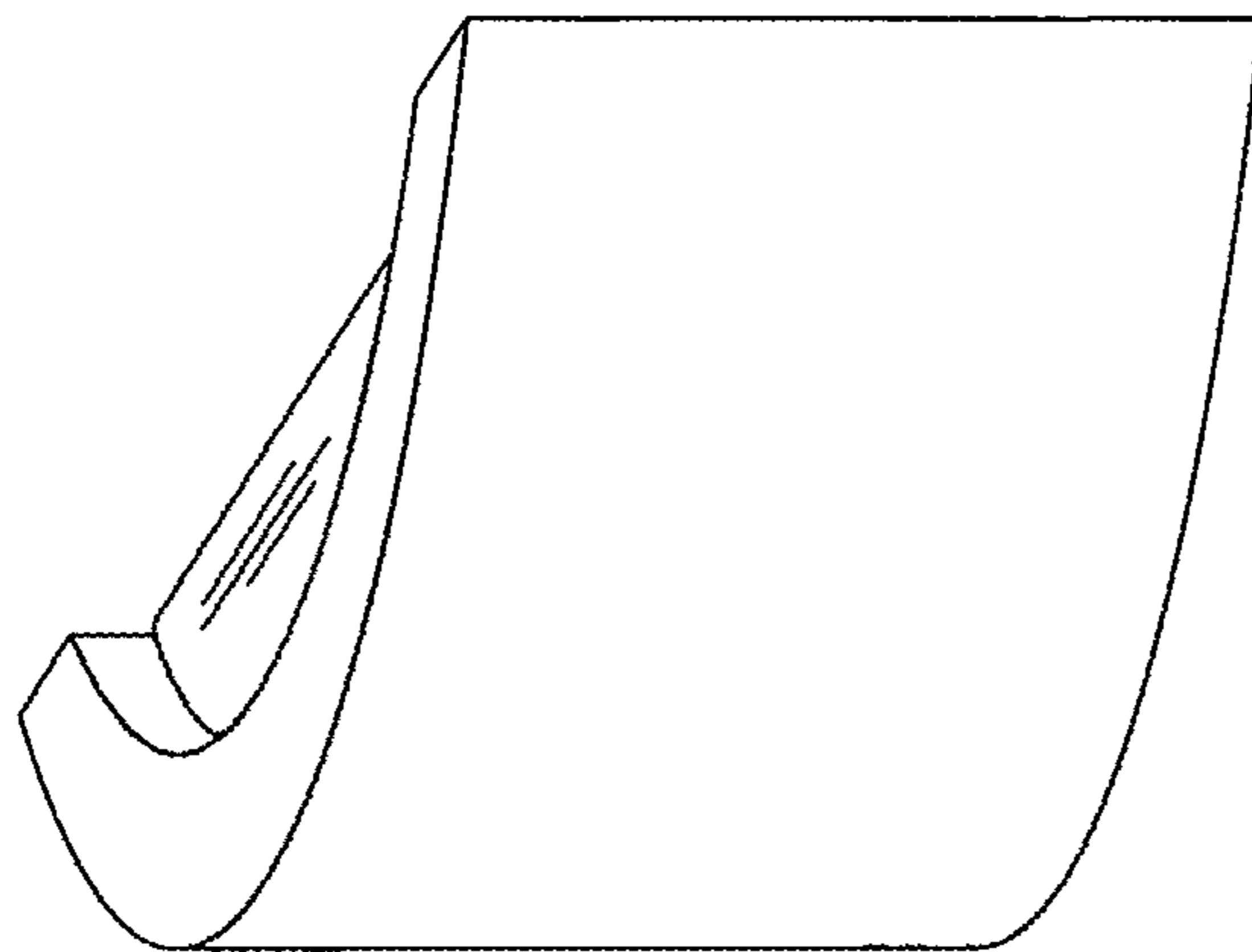

Fig. 8

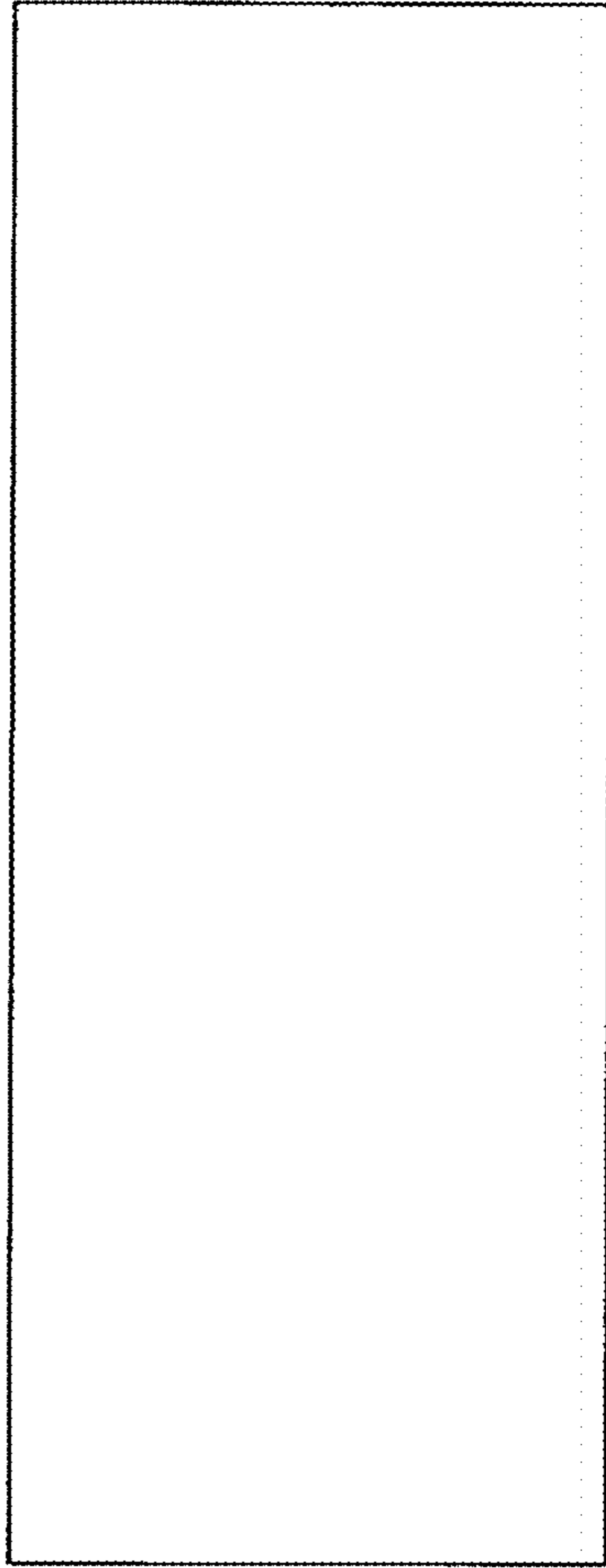

Fig. 9

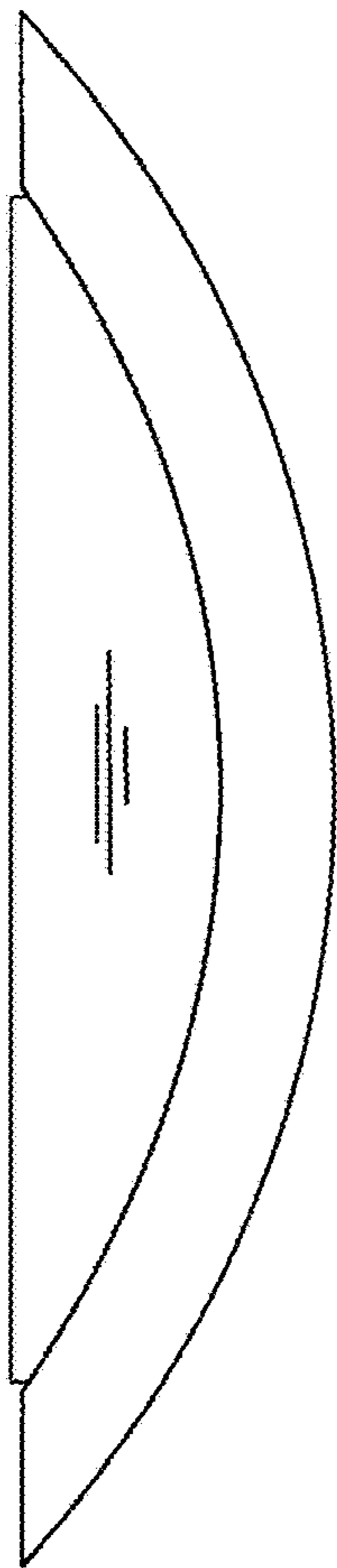

Fig. 10

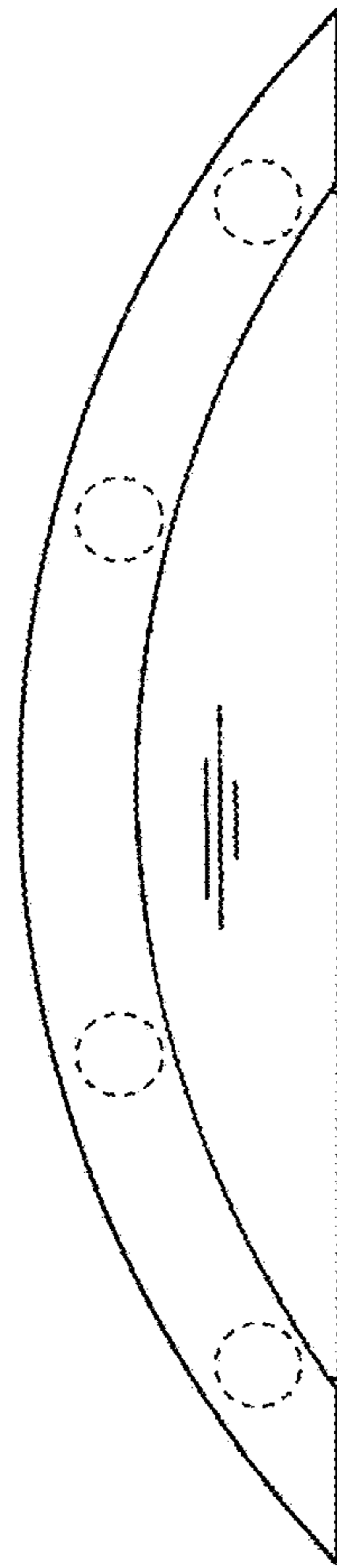

Fig. 11

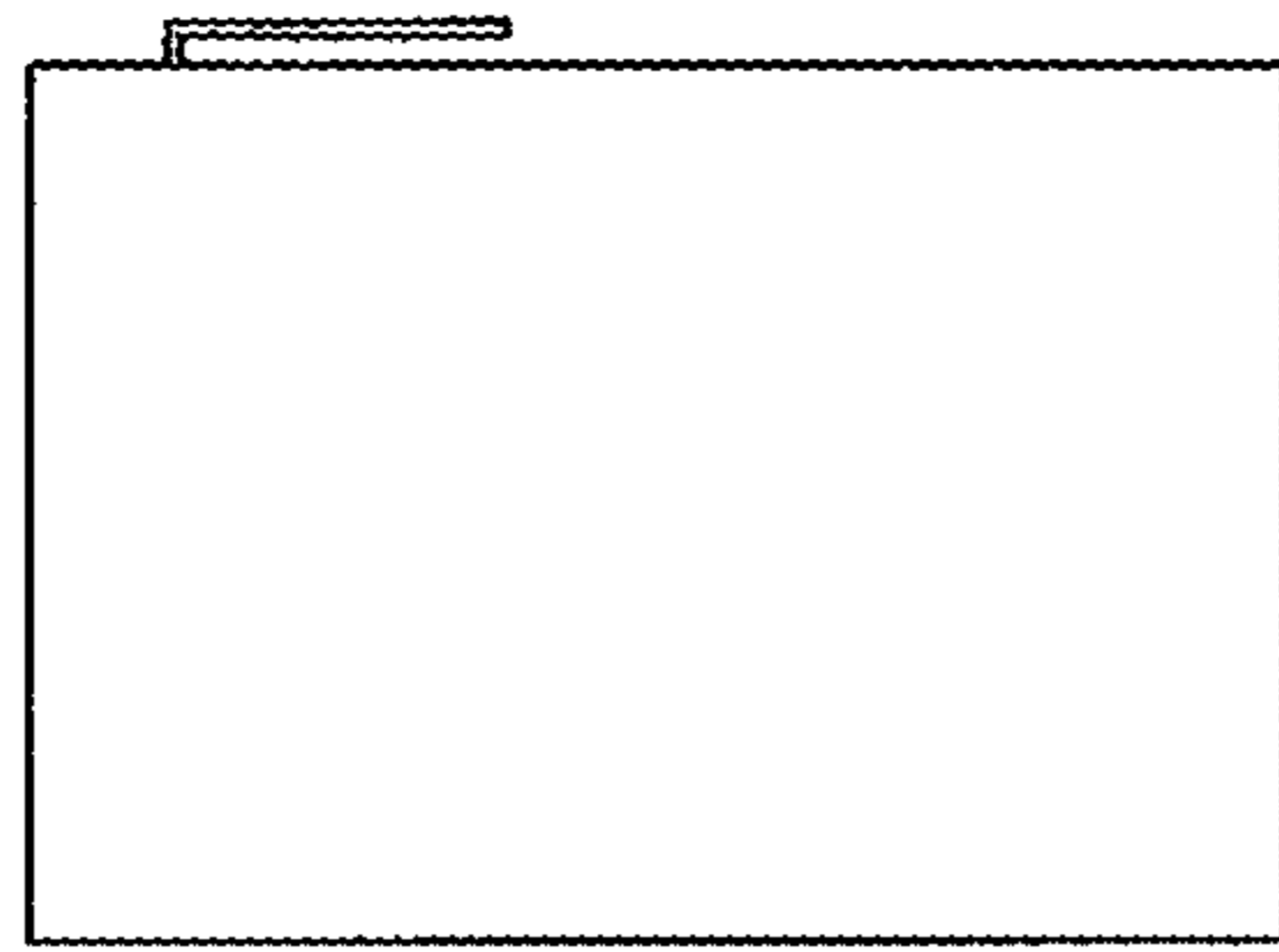

Fig. 13

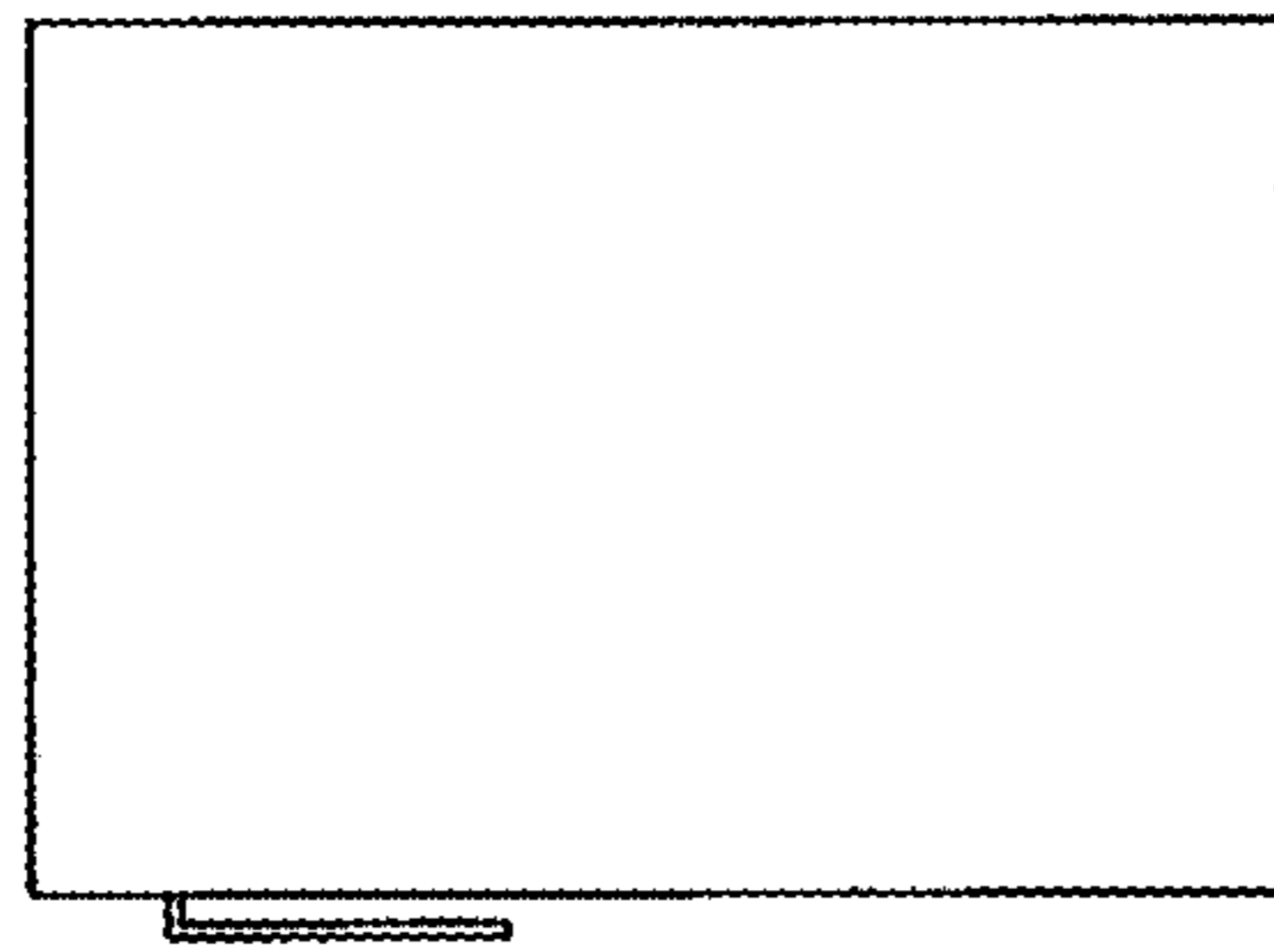

Fig. 12

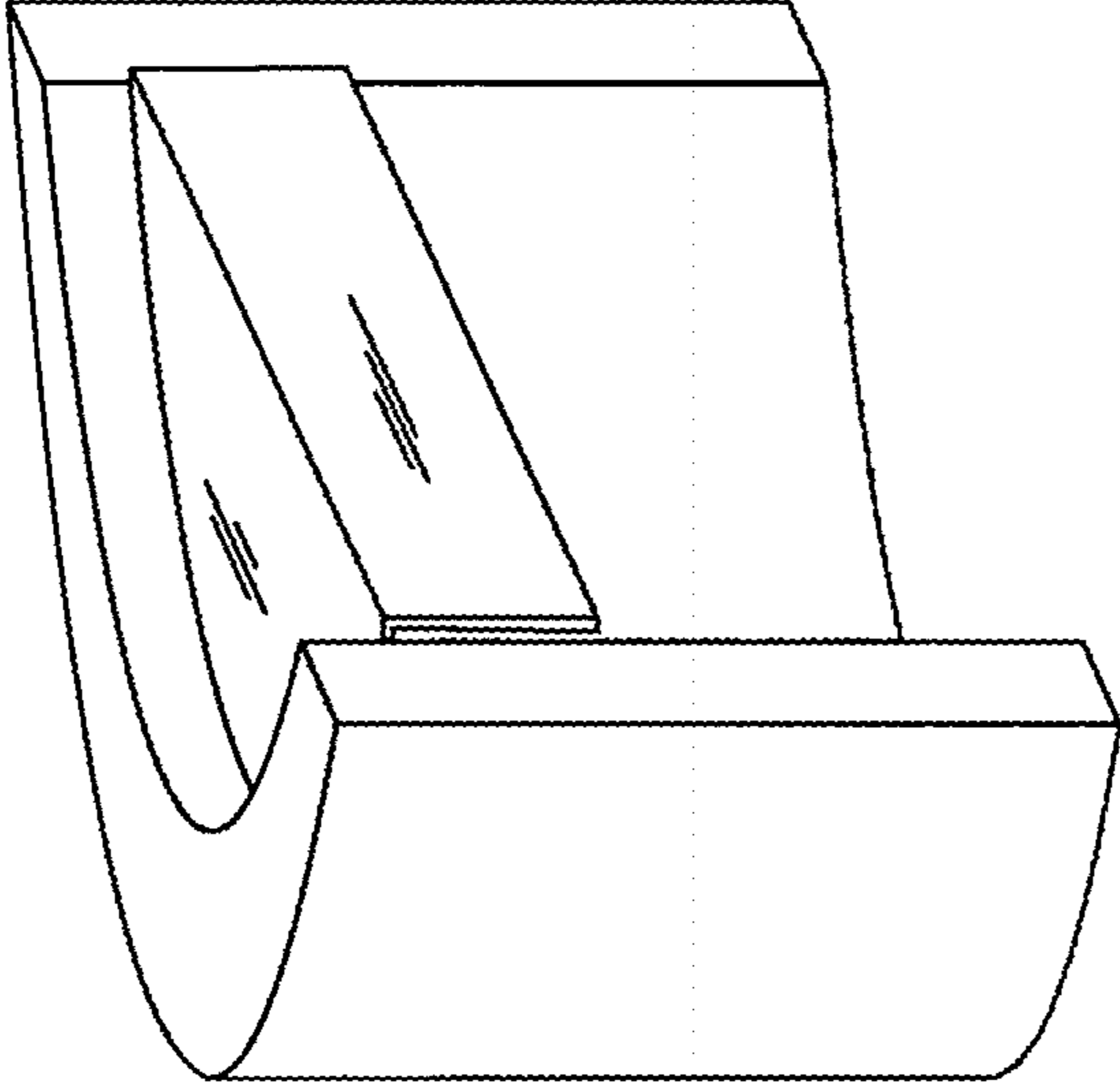

Fig. 14