



US00D867012S

(12) **United States Design Patent** (10) **Patent No.:** **US D867,012 S**
Yeo (45) **Date of Patent:** **** Nov. 19, 2019**

(54) **COUPLING DEVICE**

(71) Applicant: **Oliver Yeo**, Devon (GB)

(72) Inventor: **Oliver Yeo**, Devon (GB)

(**) Term: **15 Years**

(21) Appl. No.: **29/643,215**

(22) Filed: **Apr. 5, 2018**

(51) **LOC (12) Cl.** **23-02**

(52) **U.S. Cl.**
USPC **D6/523**

(58) **Field of Classification Search**
USPC D6/523, 512, 518, 519, 520, 522;
D19/67-69, 75, 78, 86, 87, 89, 91, 92;
206/215, 425, 449; 211/11, 45, 50,
211/126.16, 26; 242/559, 560, 588.3,
242/588.4, 590
CPC A47K 10/38; A47K 10/3687; A47K
2010/3253; A47K 10/3643; A47K
2010/3881; A47K 10/3625; A47K
10/3656; A47K 10/18; A47K 2010/3286;
A47K 2010/36

See application file for complete search history.

(56) **References Cited**

U.S. PATENT DOCUMENTS

D727,058 S * 4/2015 Morand D6/523
D827,324 S * 9/2018 Chen D6/518

2013/0134181 A1* 5/2013 Helseth B65H 16/005
221/26
2017/0267412 A1* 9/2017 Krause B65D 33/007

* cited by examiner

Primary Examiner — Wan Laymon

Assistant Examiner — Mark Booker

(74) *Attorney, Agent, or Firm* — Reichel Stohry Dean

LLP; Mark C. Reichel; Natalie J. Dean

(57) **CLAIM**

The ornamental design for a coupling device, as shown and described.

DESCRIPTION

FIG. 1 is a front perspective view of a coupling device showing my new design;
FIG. 2 is a right side view thereof;
FIG. 3 is a left side view thereof;
FIG. 4 is a front view thereof;
FIG. 5 is a back view thereof;
FIG. 6 is a top view thereof; and,
FIG. 7 is a bottom view thereof.

The broken lines in the drawing depict portions of the coupling device that form no part of the claimed design.

1 Claim, 7 Drawing Sheets

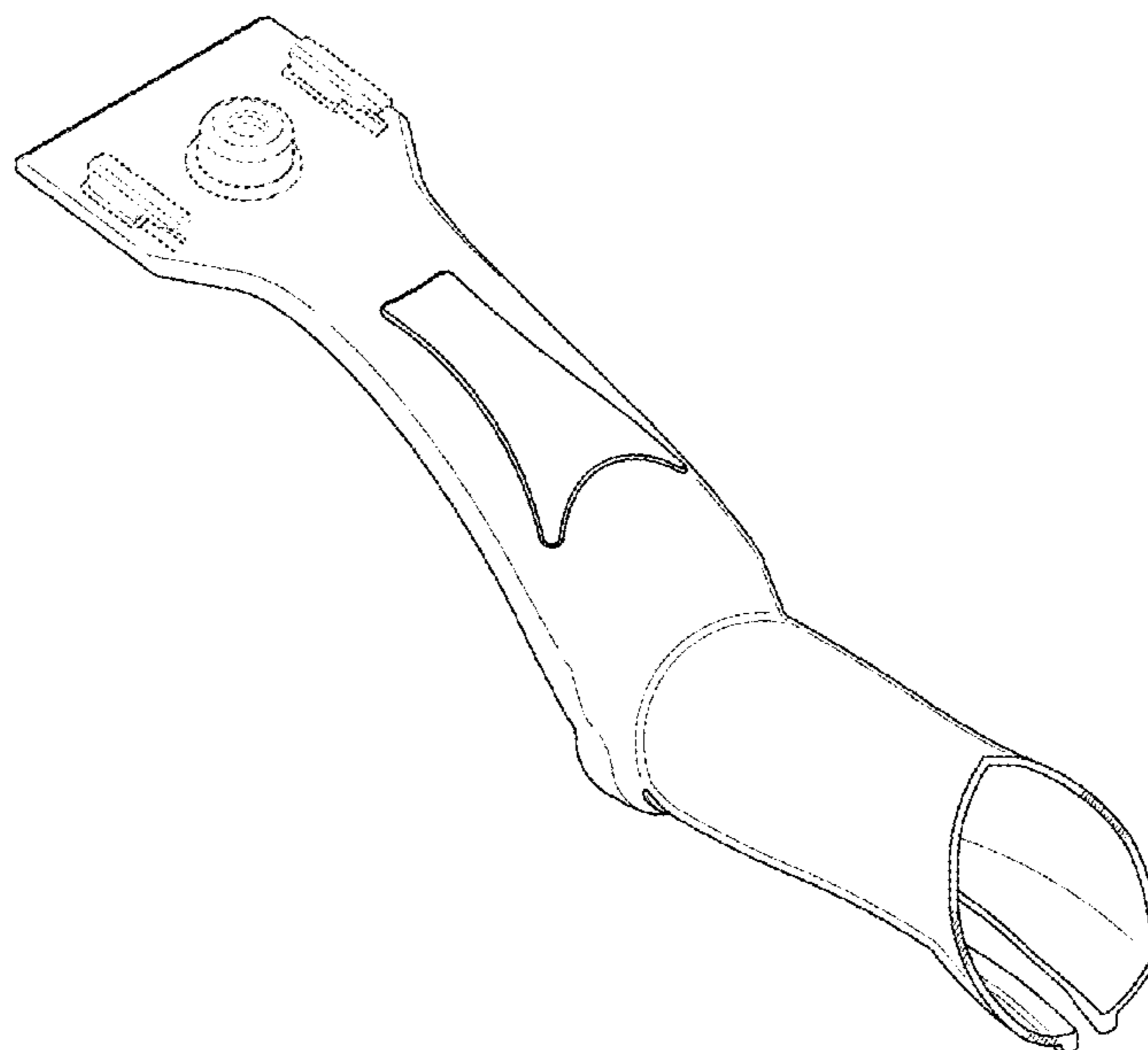

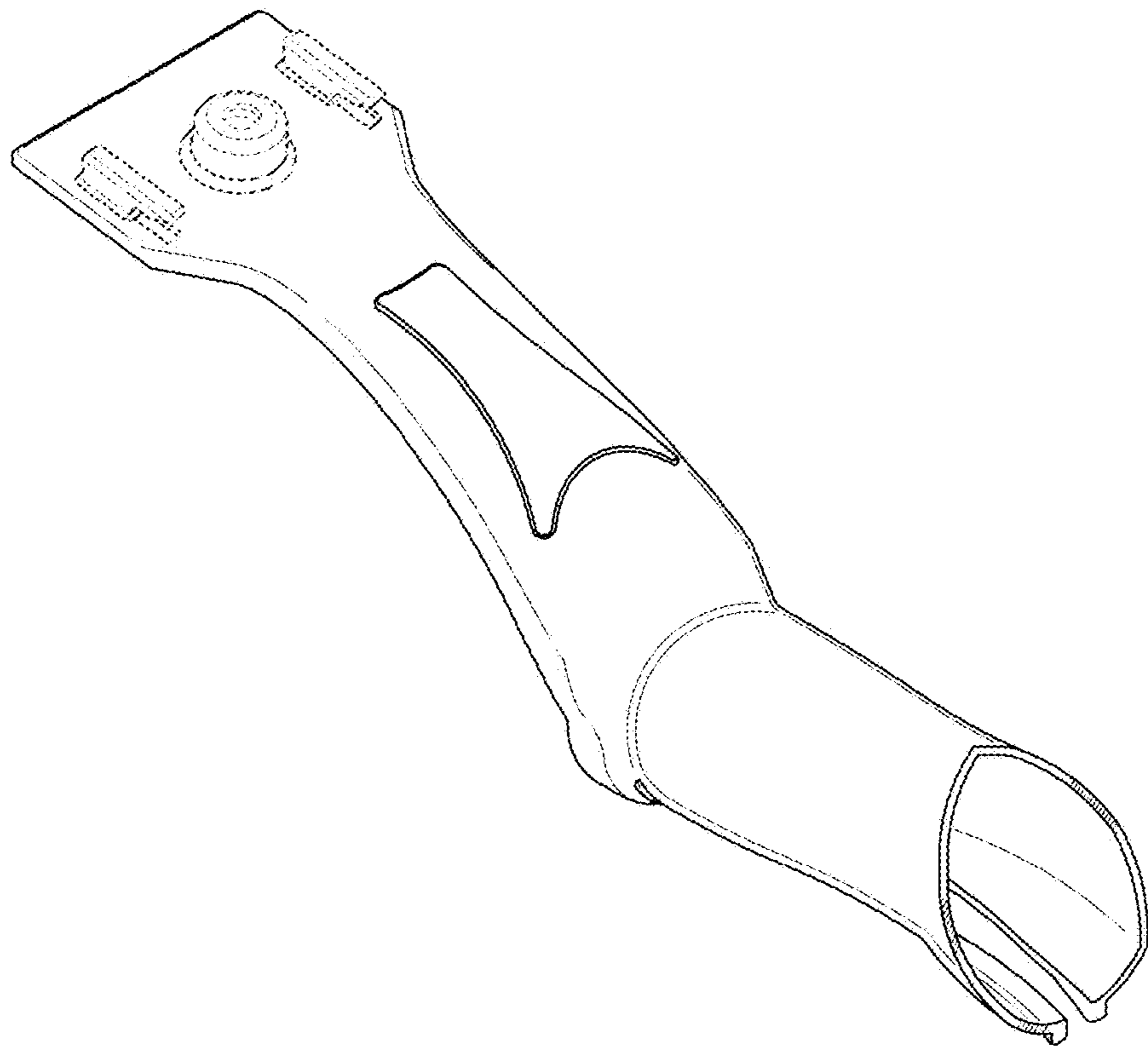

FIG. 1

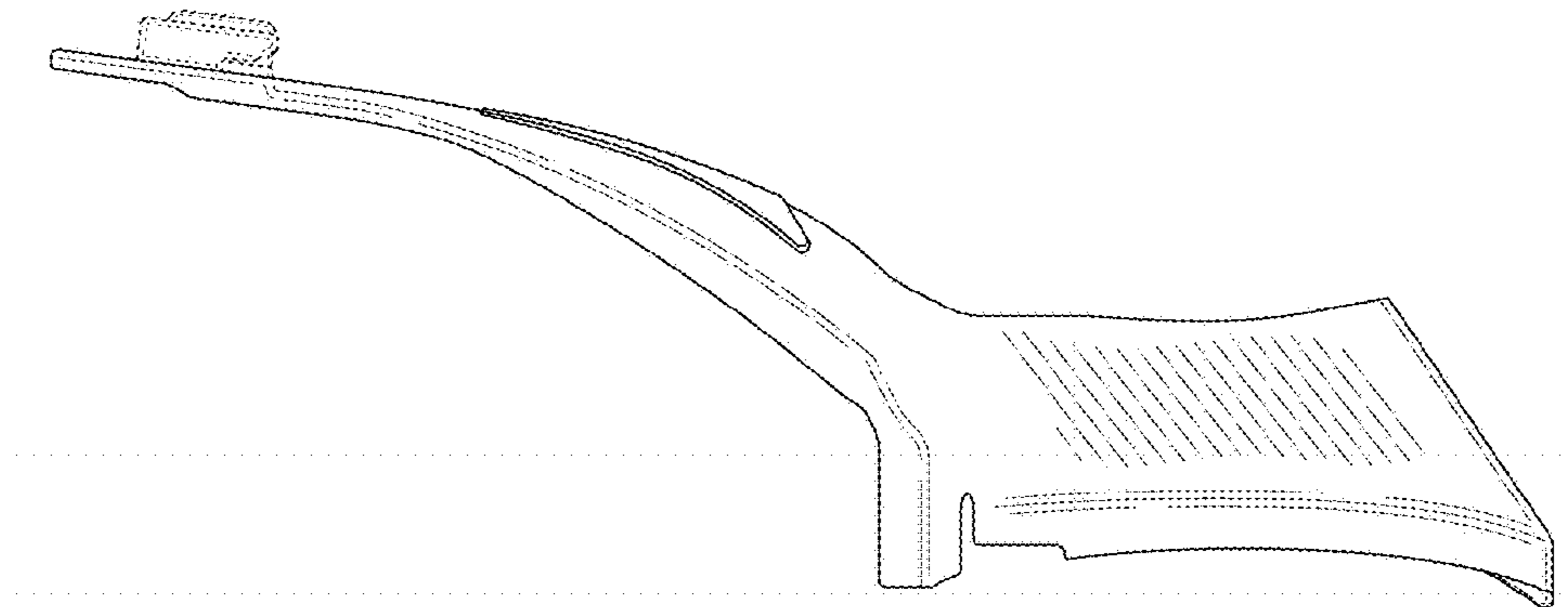

FIG. 2

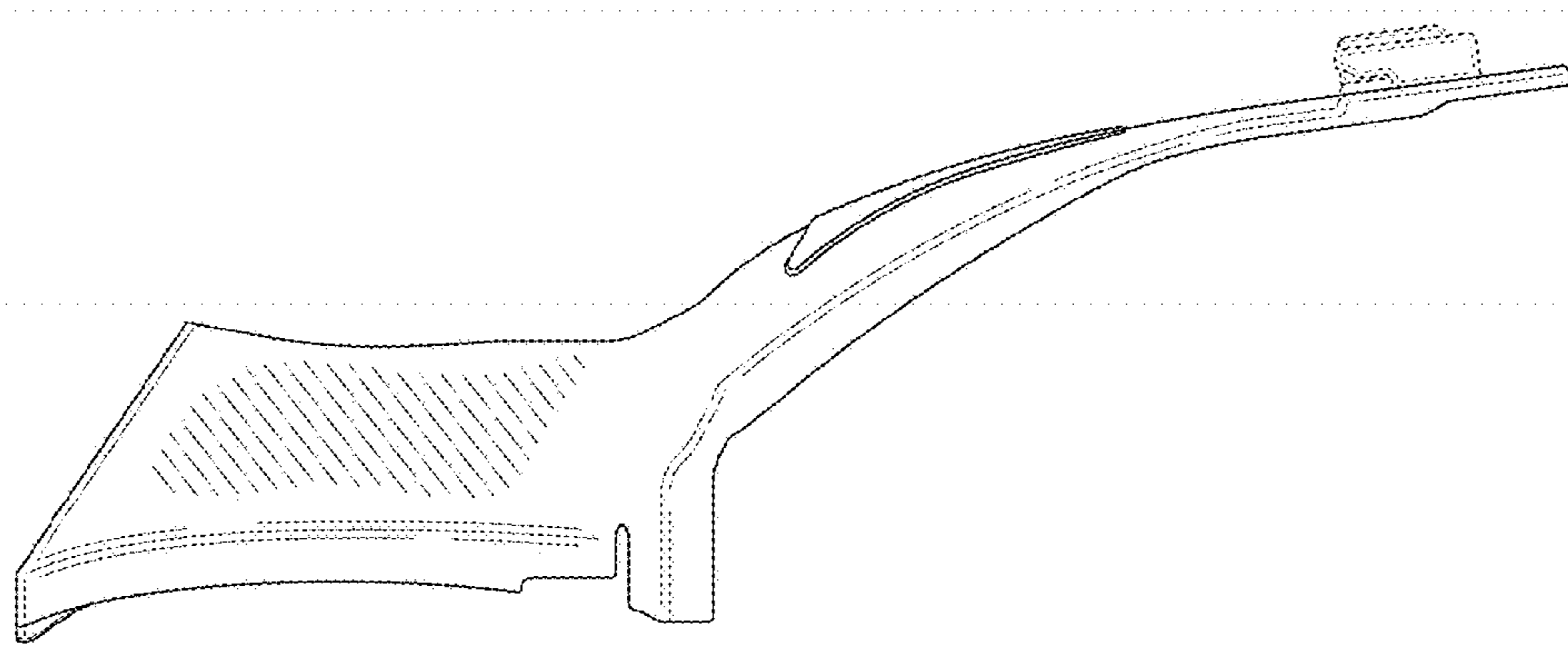

FIG. 3

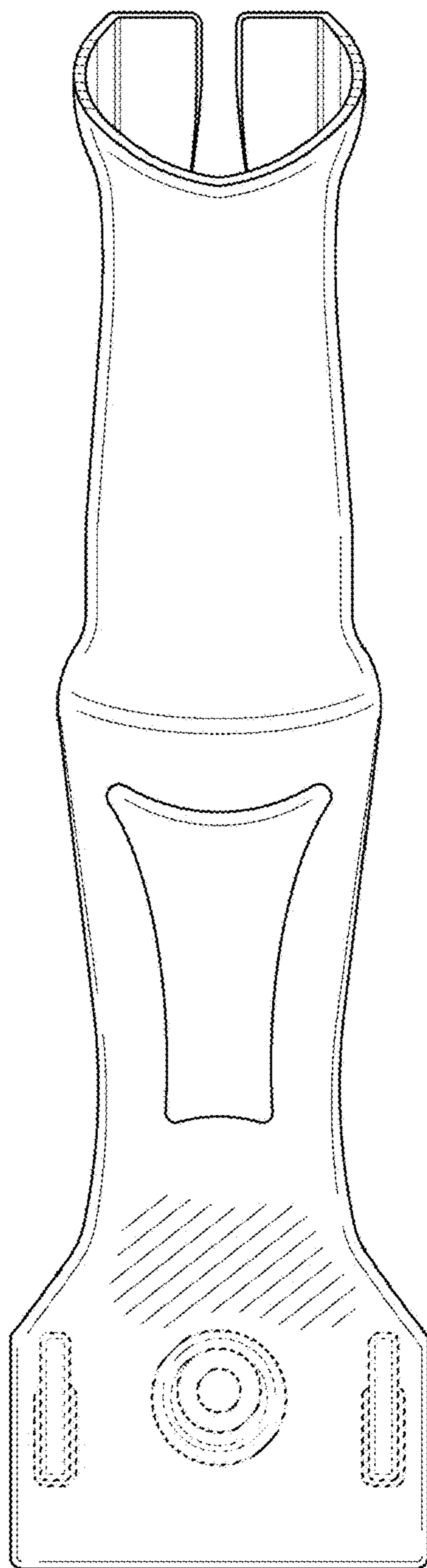

FIG. 4

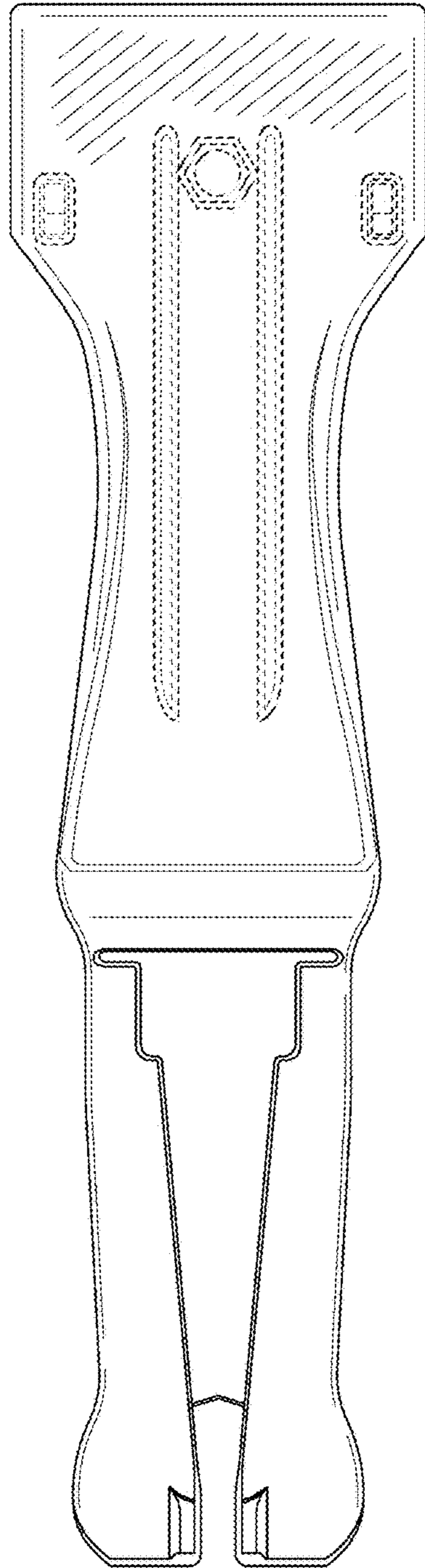

FIG. 5

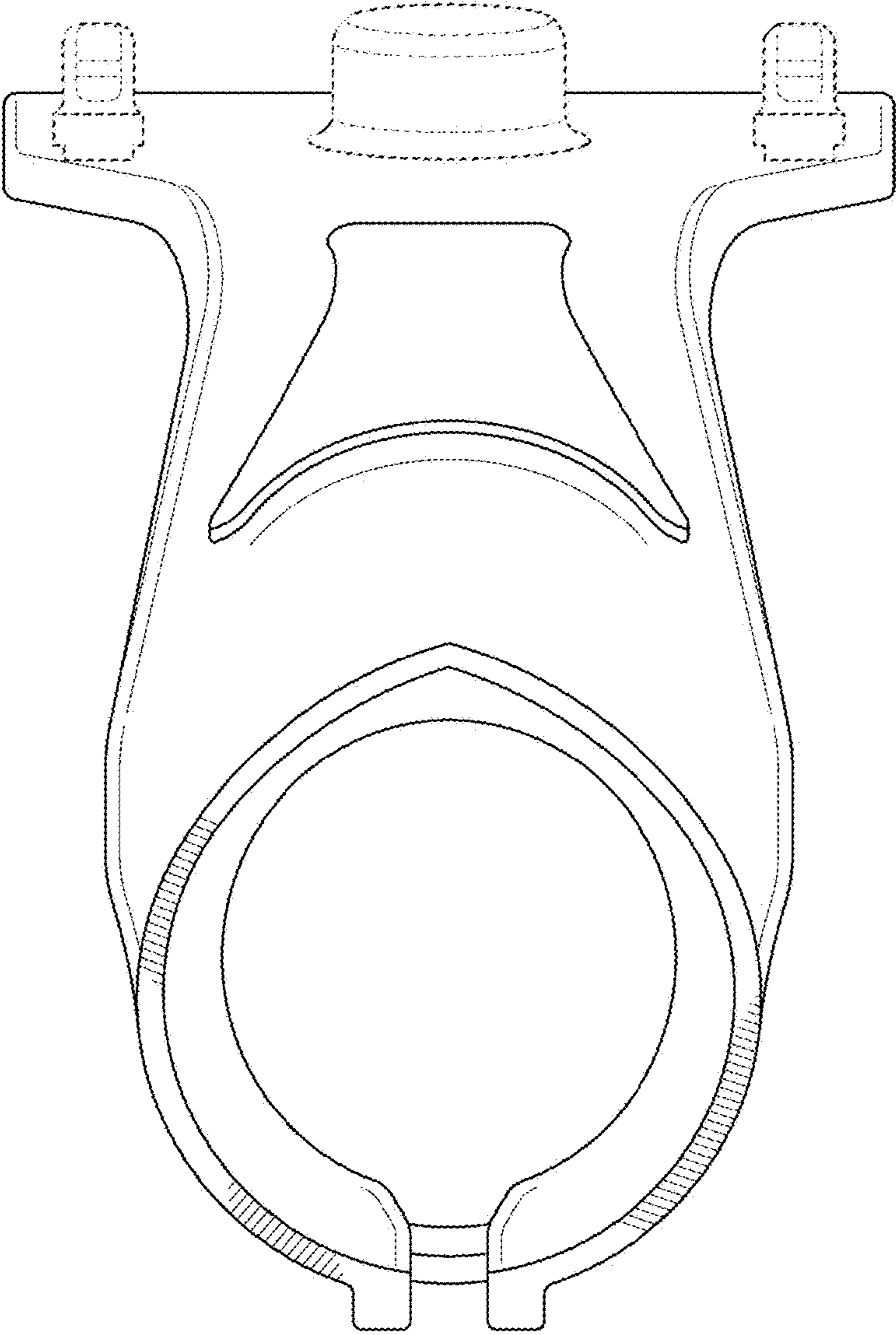

FIG. 6

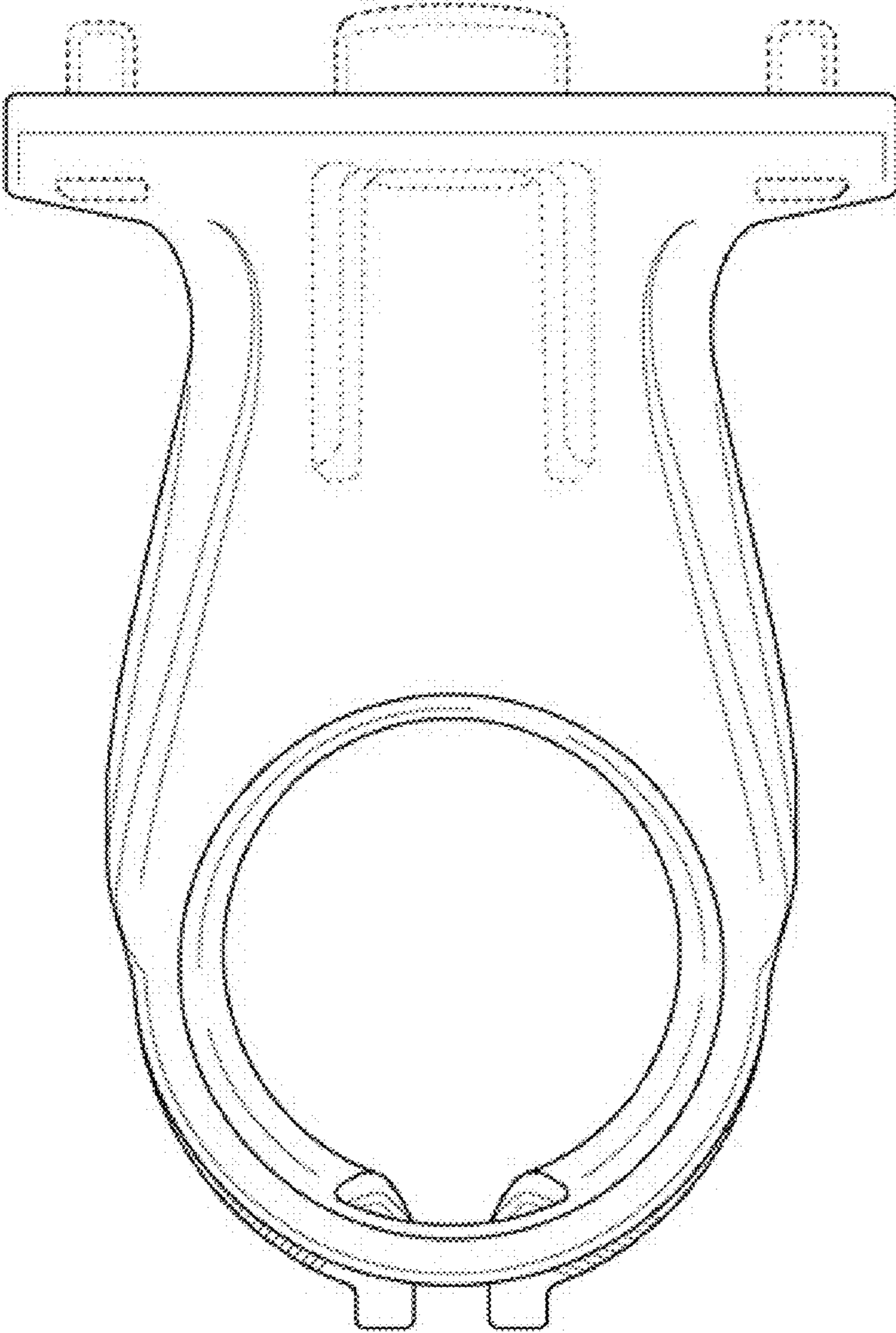

FIG. 7