



US00D866922S

(12) **United States Design Patent**  
**Miller et al.**

(10) **Patent No.:** **US D866,922 S**  
(45) **Date of Patent:** **\*\* Nov. 19, 2019**

(54) **BODYSUIT**

FOREIGN PATENT DOCUMENTS

(71) Applicants: **Jonathan Kyle Miller**, Garland, TX  
(US); **Barbara Rosin**, Los Angeles, CA  
(US)

CA 2971961 A1 \* 11/2018 ..... A41D 13/0017  
JP 2007119994 A \* 5/2007

\* cited by examiner

(72) Inventors: **Jonathan Kyle Miller**, Garland, TX  
(US); **Barbara Rosin**, Los Angeles, CA  
(US)

*Primary Examiner* — R. Johnson

(74) *Attorney, Agent, or Firm* — Dunlap Bennett &  
Ludwig PLLC

(\*\*) Term: **15 Years**

(21) Appl. No.: **29/592,861**

(22) Filed: **Feb. 3, 2017**

(51) **LOC (12) Cl.** ..... **02-01**

(52) **U.S. Cl.**  
USPC ..... **D2/731**

(58) **Field of Classification Search**  
USPC ..... D2/731–735, 700, 704; 2/67  
CPC ..... A41D 7/00; A41D 7/006  
See application file for complete search history.

(57) **CLAIM**

The ornamental design for a bodysuit, as shown and described.

**DESCRIPTION**

FIG. 1 is a front perspective view of a first embodiment of a bodysuit;  
FIG. 2 is a front elevation view of FIG. 1;  
FIG. 3 is a rear elevation view of FIG. 1;  
FIG. 4 is a left elevation view of FIG. 1;  
FIG. 5 is a right elevation view of FIG. 1;  
FIG. 6 is a top plan view of FIG. 1;  
FIG. 7 is a bottom plan view of FIG. 1;  
FIG. 8 is a front perspective view of a second embodiment of the bodysuit;  
FIG. 9 is a front elevation view of FIG. 8;  
FIG. 10 is a rear elevation view of FIG. 8;  
FIG. 11 is a left elevation view of FIG. 8, the right elevation view being a mirror image of FIG. 11;  
FIG. 12 is a top plan view of FIG. 8; and,  
FIG. 13 is a bottom plan view of FIG. 8.  
The evenly sized broken lines shown in the drawings depict portions of the bodysuit that form no part of the claimed design, while the unevenly sized (dash-dot-dash) broken lines represent the bounds of the claimed design.

(56) **References Cited**

U.S. PATENT DOCUMENTS

2,685,691	A *	8/1954	Artz	.....	A41B 9/08
					2/109
D202,098	S *	8/1965	Galitzine	.....	D2/731
3,932,896	A *	1/1976	Dottinger	.....	A41D 7/00
					2/67
5,987,650	A *	11/1999	Carroll	.....	A41D 7/00
					2/104
D462,154	S *	9/2002	Fairhurst	.....	A41D 7/00
					D2/731
D763,548	S *	8/2016	Harmande	.....	D2/731
D780,406	S *	3/2017	Brown	.....	D2/731
D785,905	S *	5/2017	Savage	.....	D2/731
D804,145	S *	12/2017	Abramowitz	.....	D2/731
2012/0185992	A1 *	7/2012	Byrnes	.....	A41D 7/00
					2/67

**1 Claim, 8 Drawing Sheets**

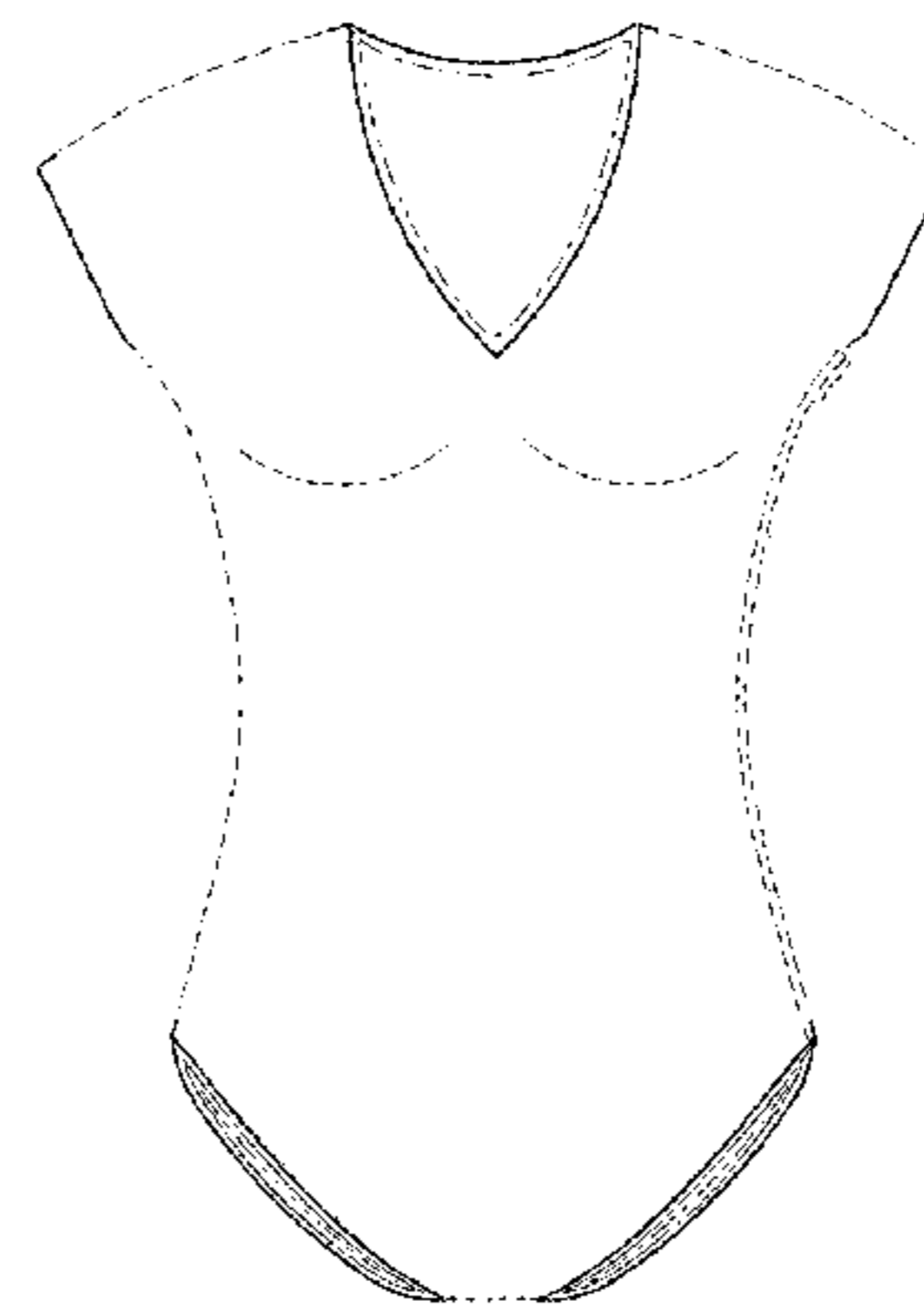
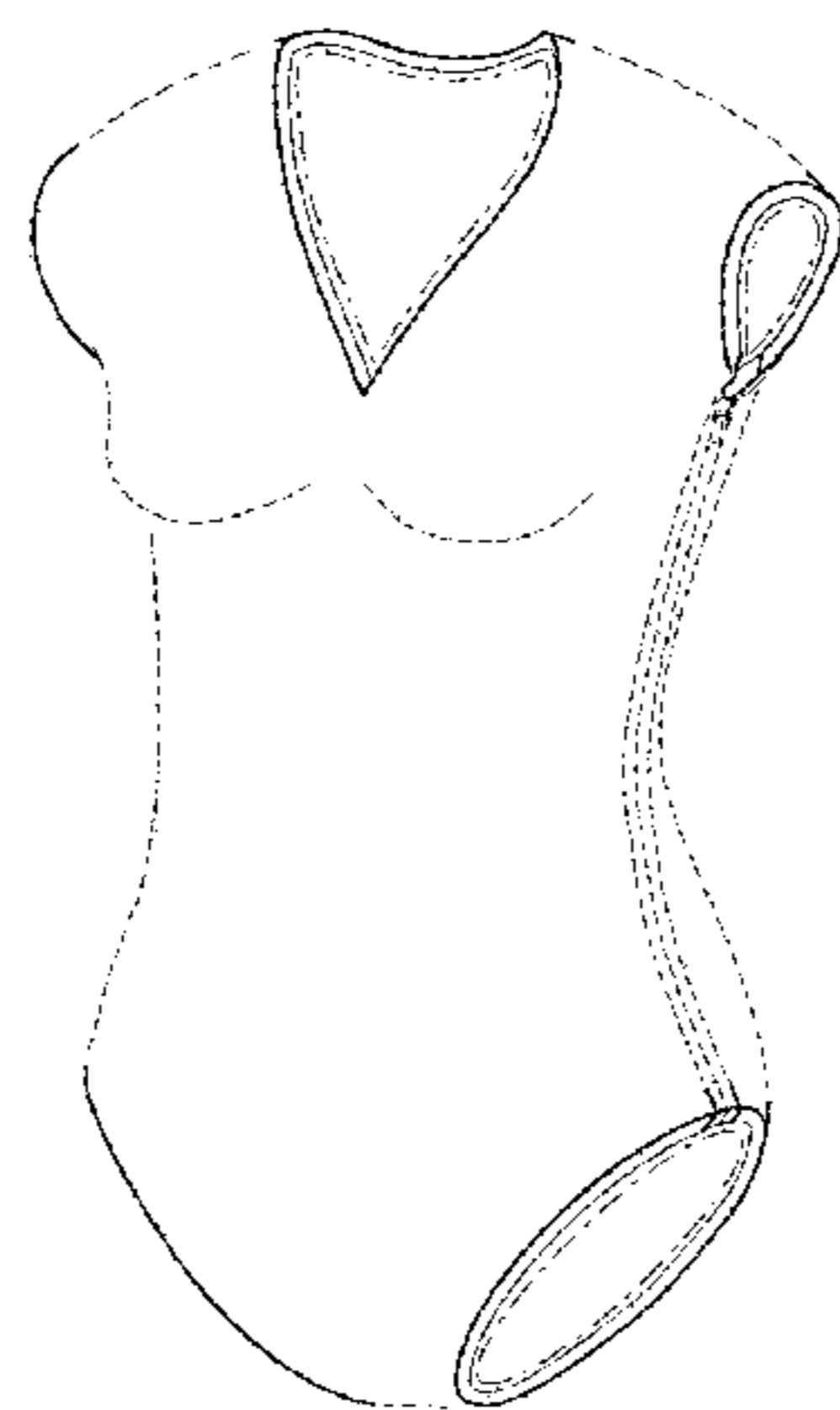

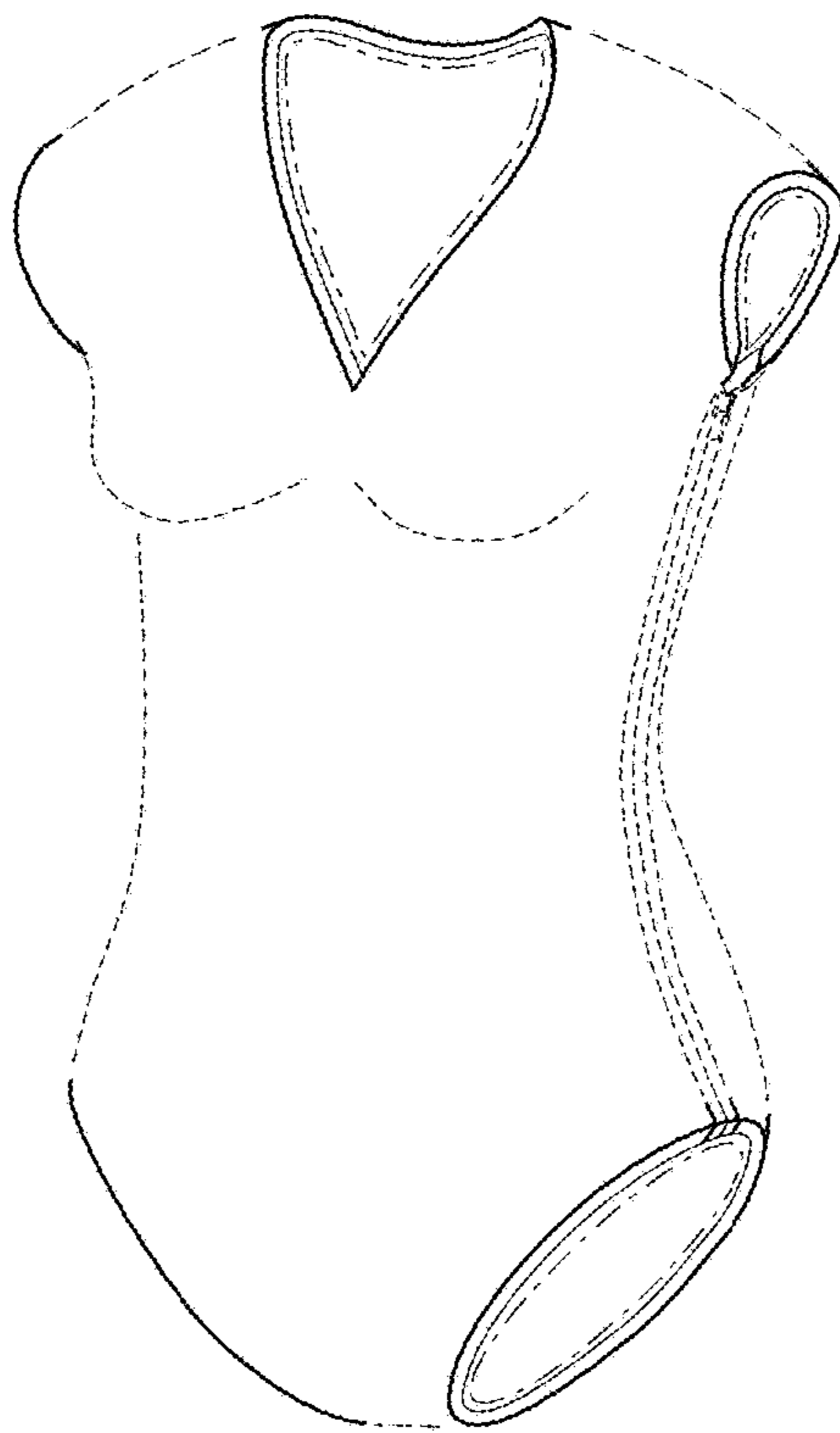

FIG. 1

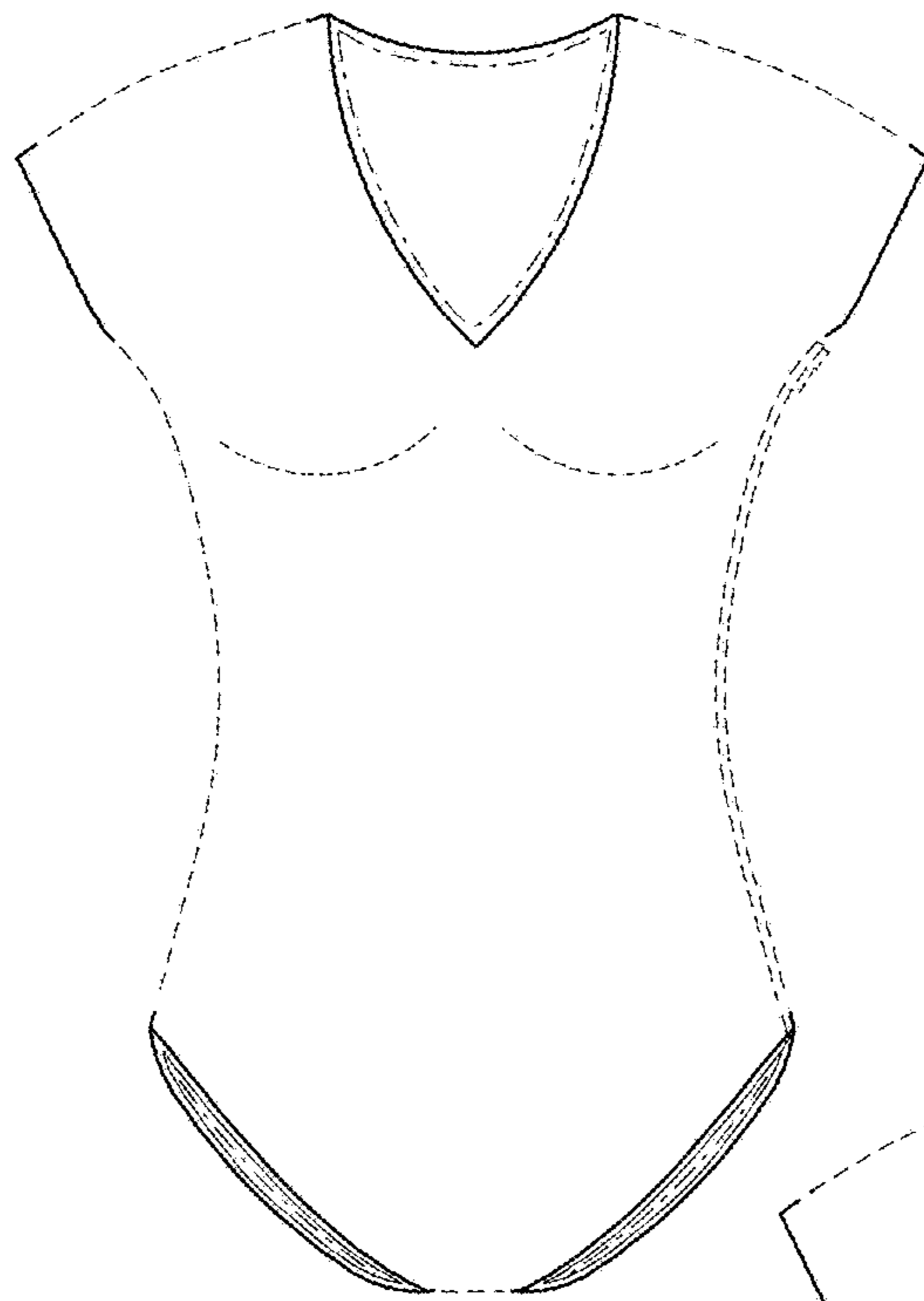

FIG. 2

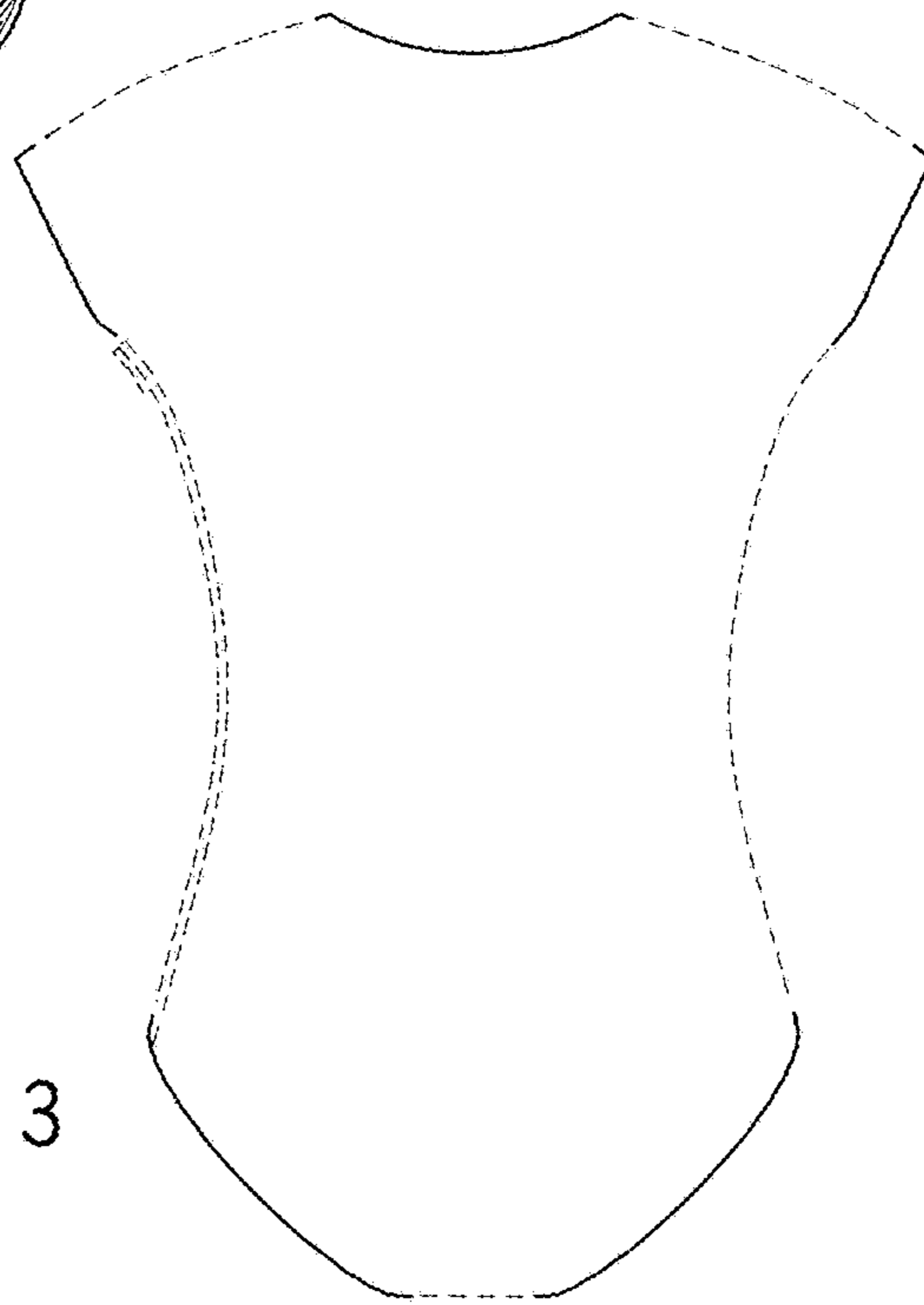

FIG. 3

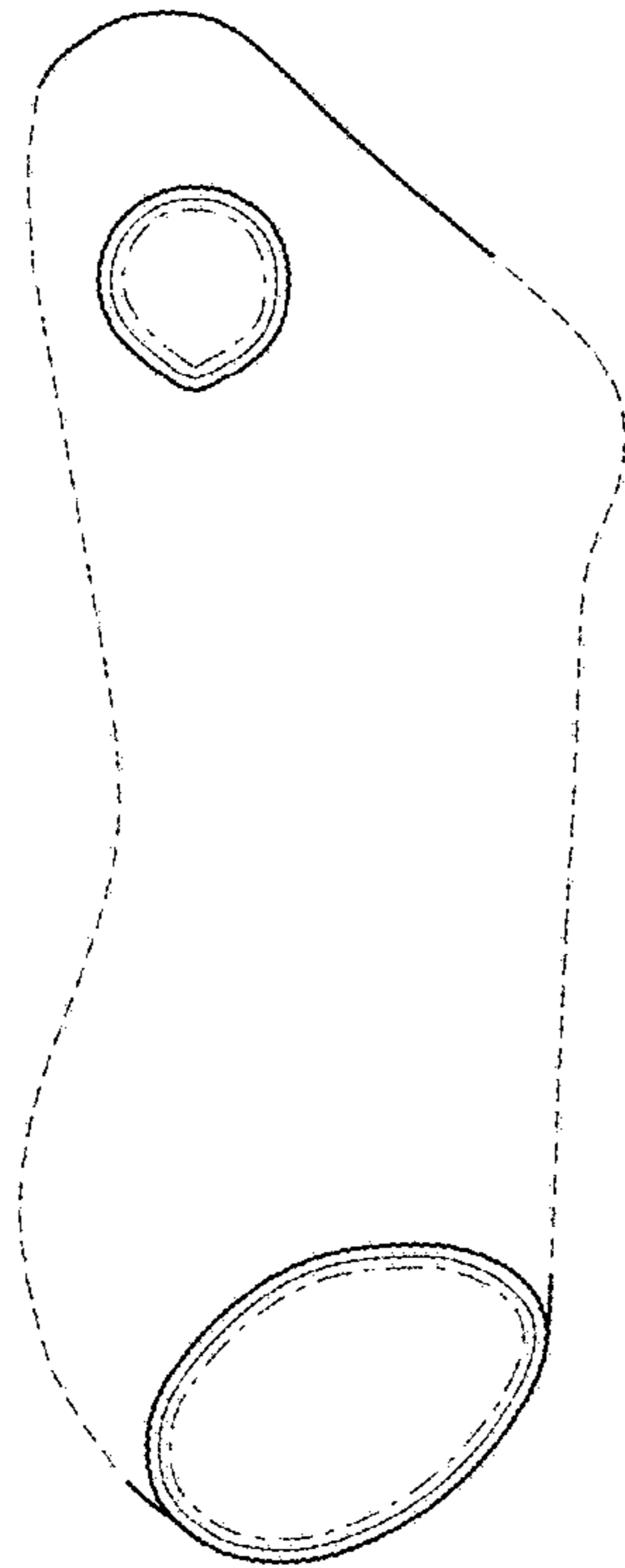

FIG. 4

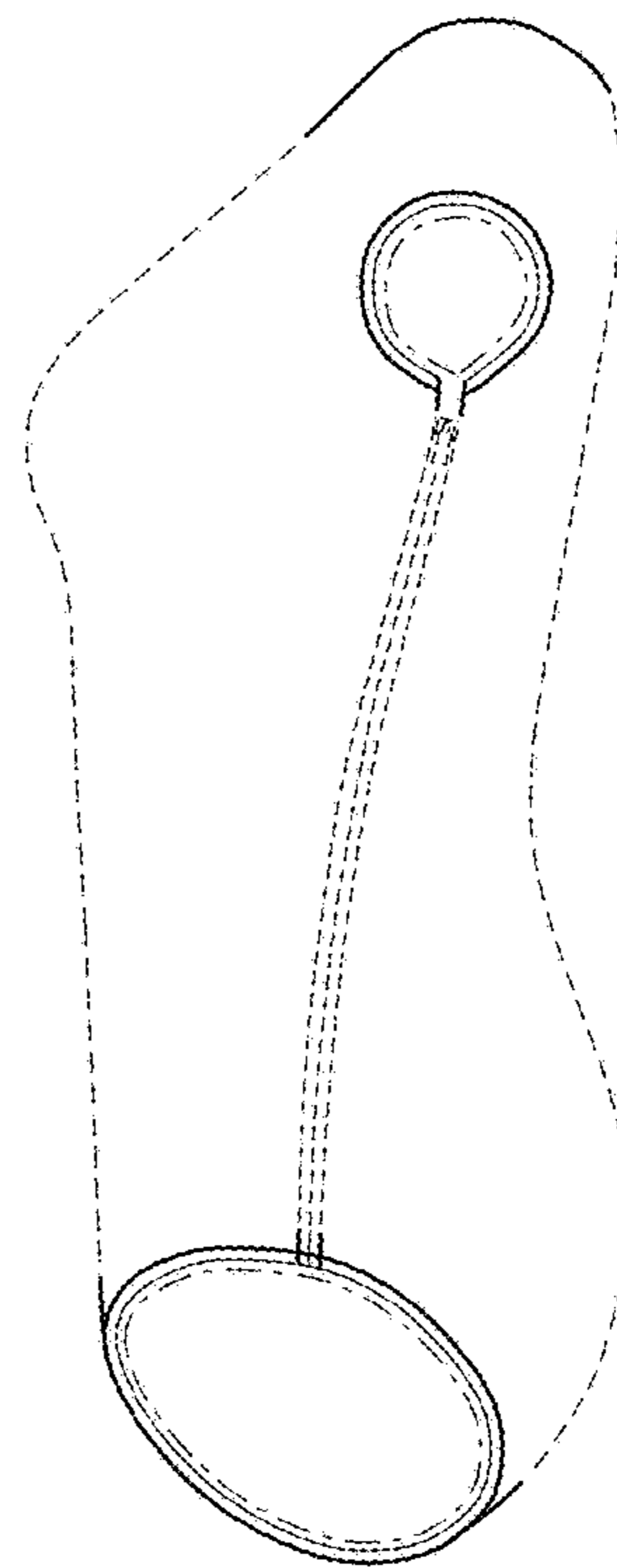

FIG. 5

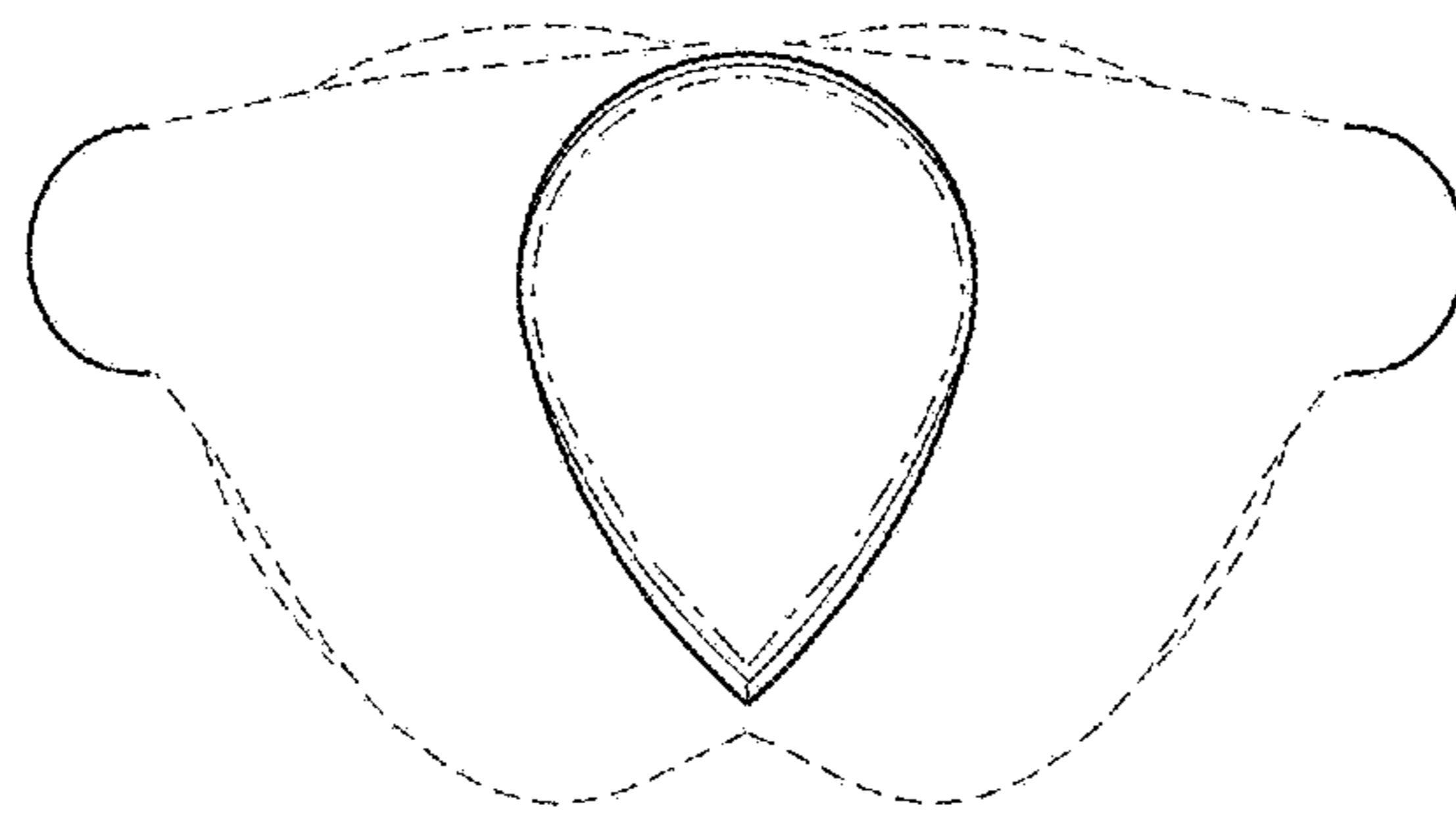

FIG. 6

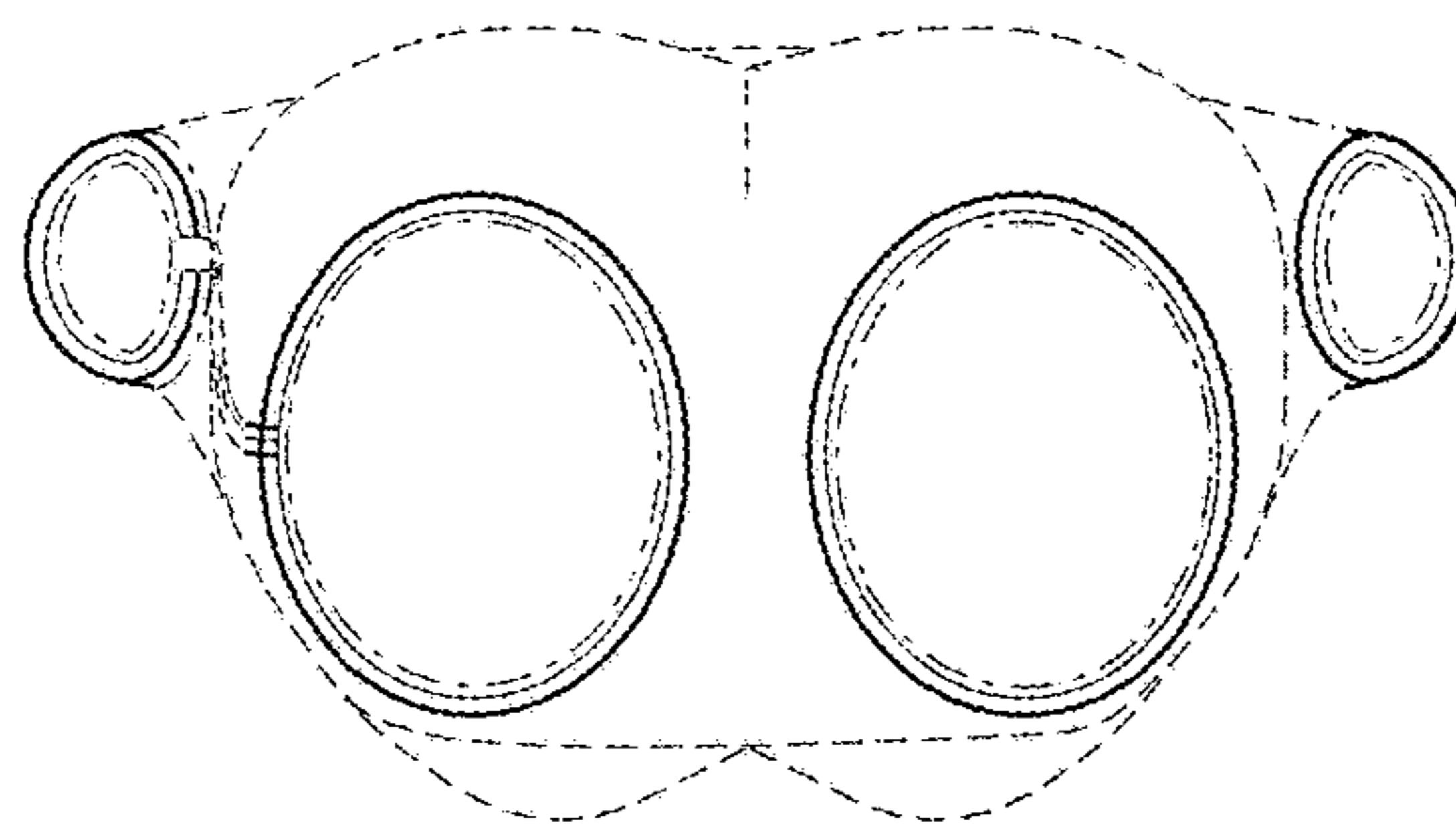

FIG. 7

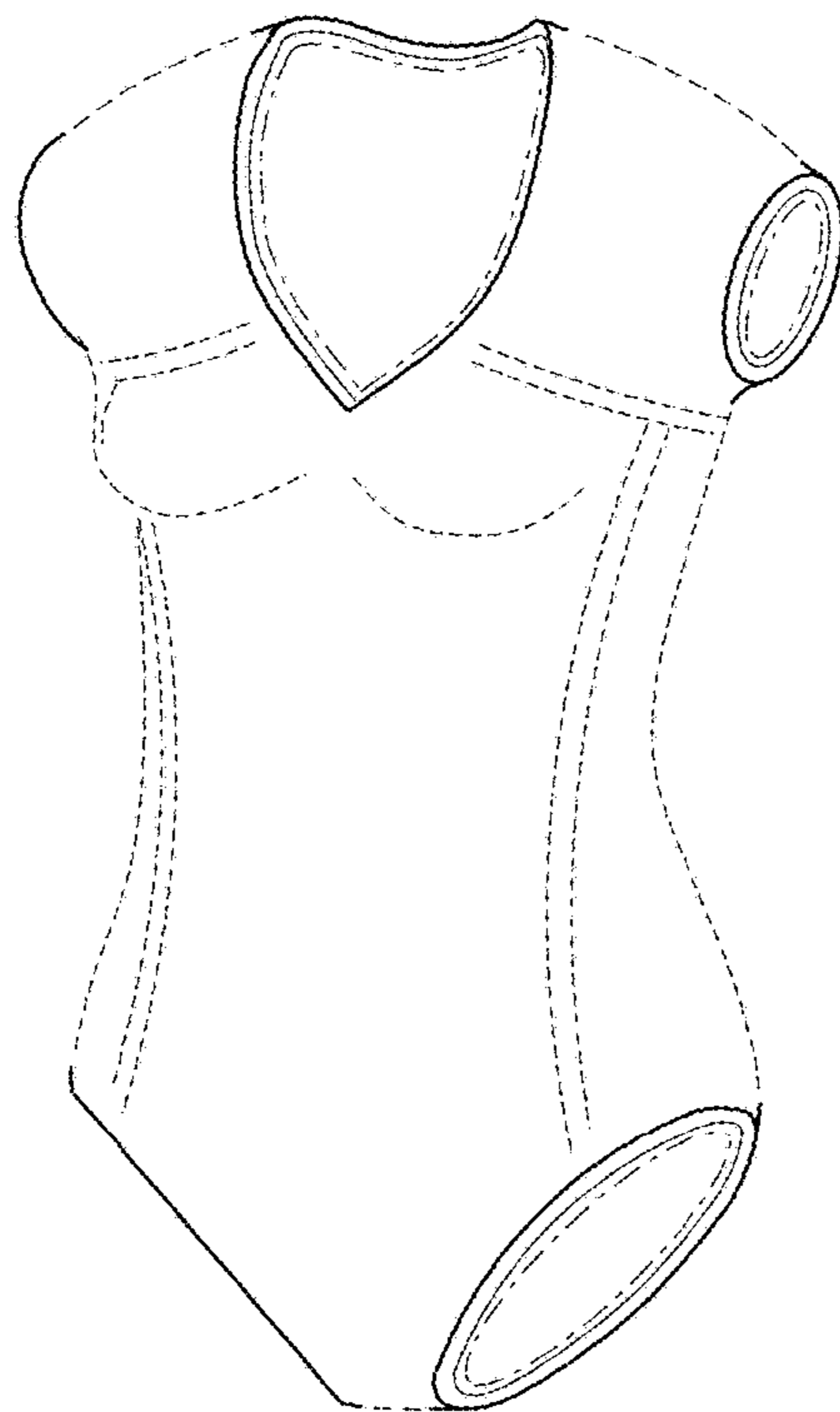

FIG. 8

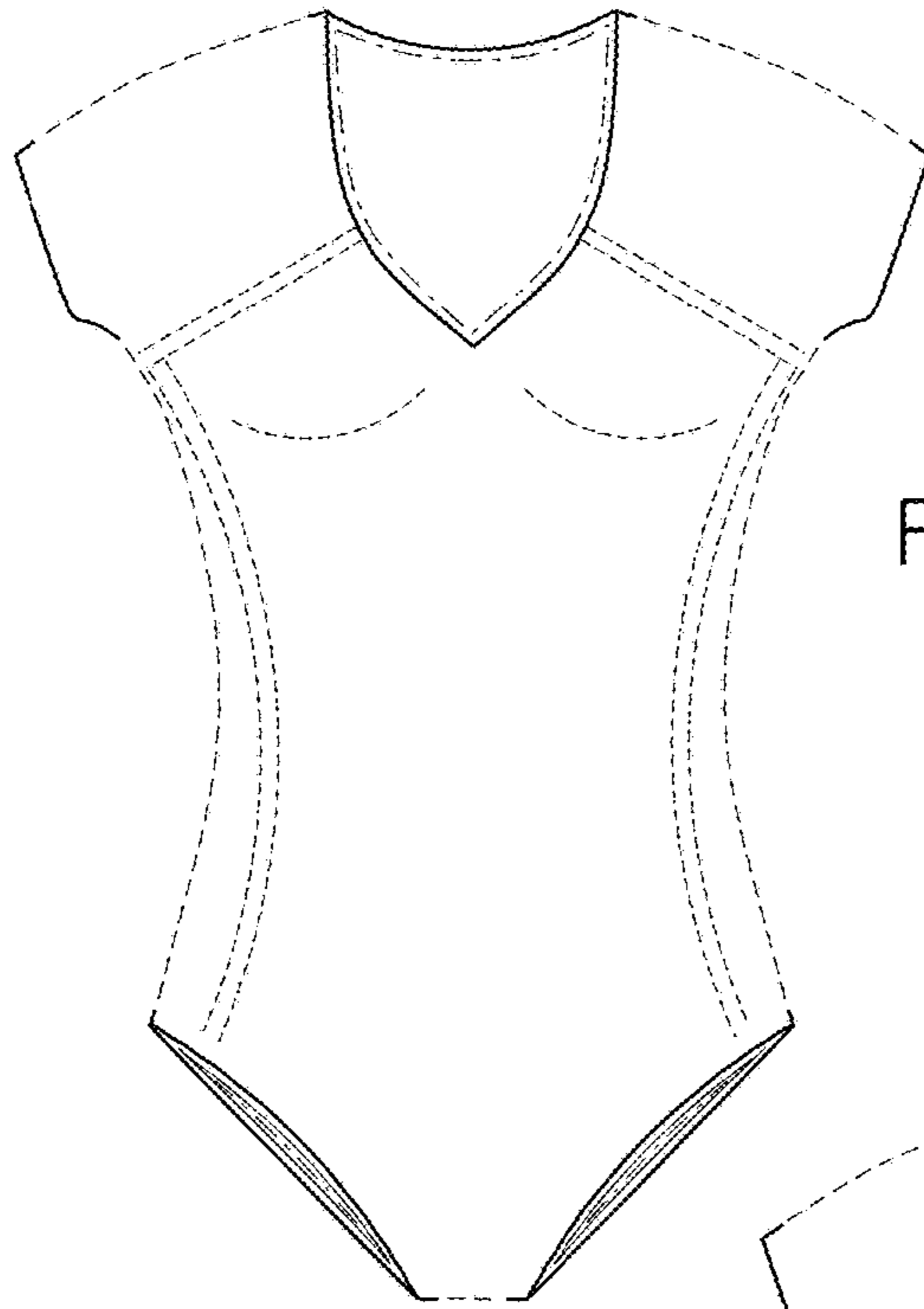
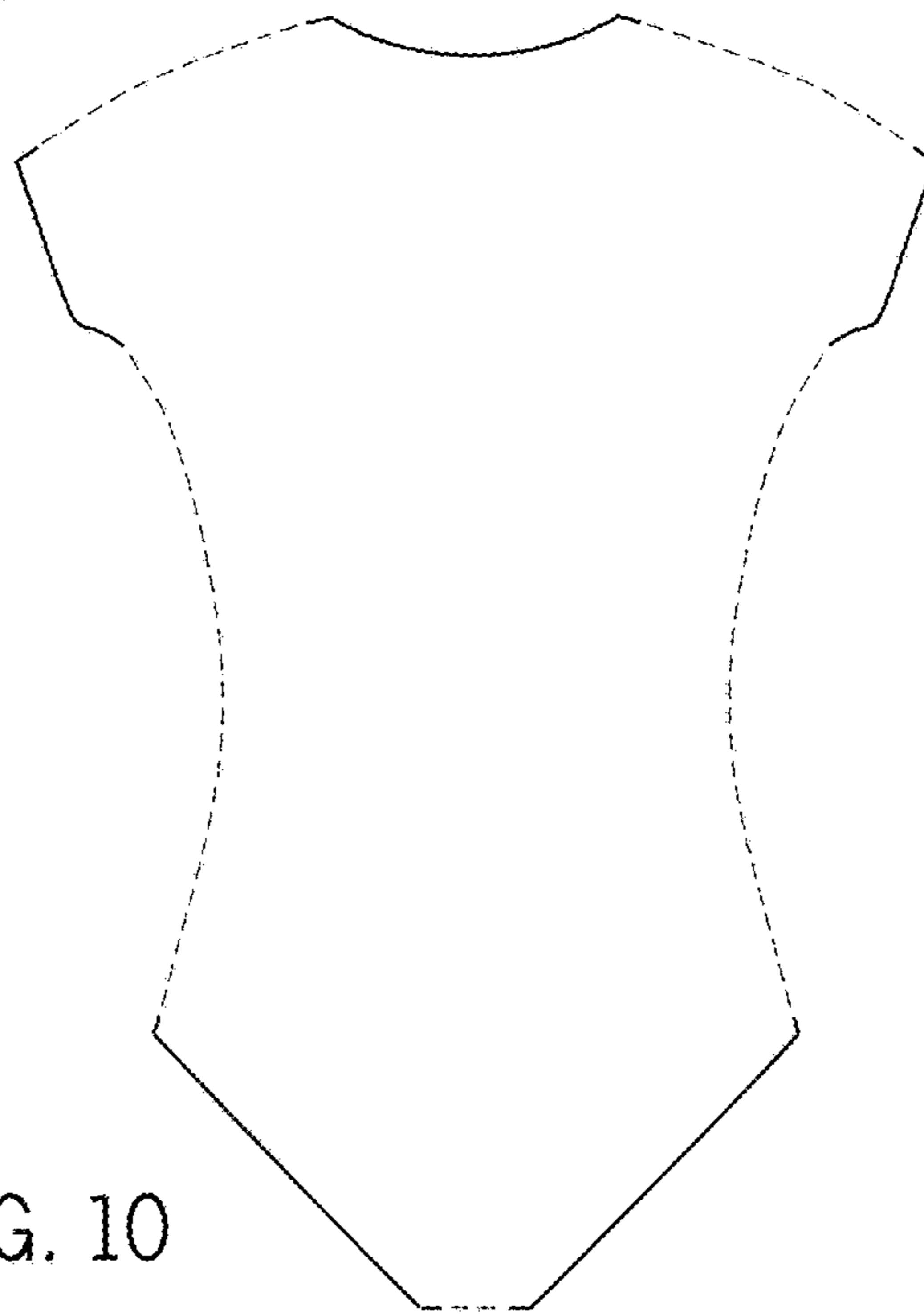

FIG. 9

FIG. 10



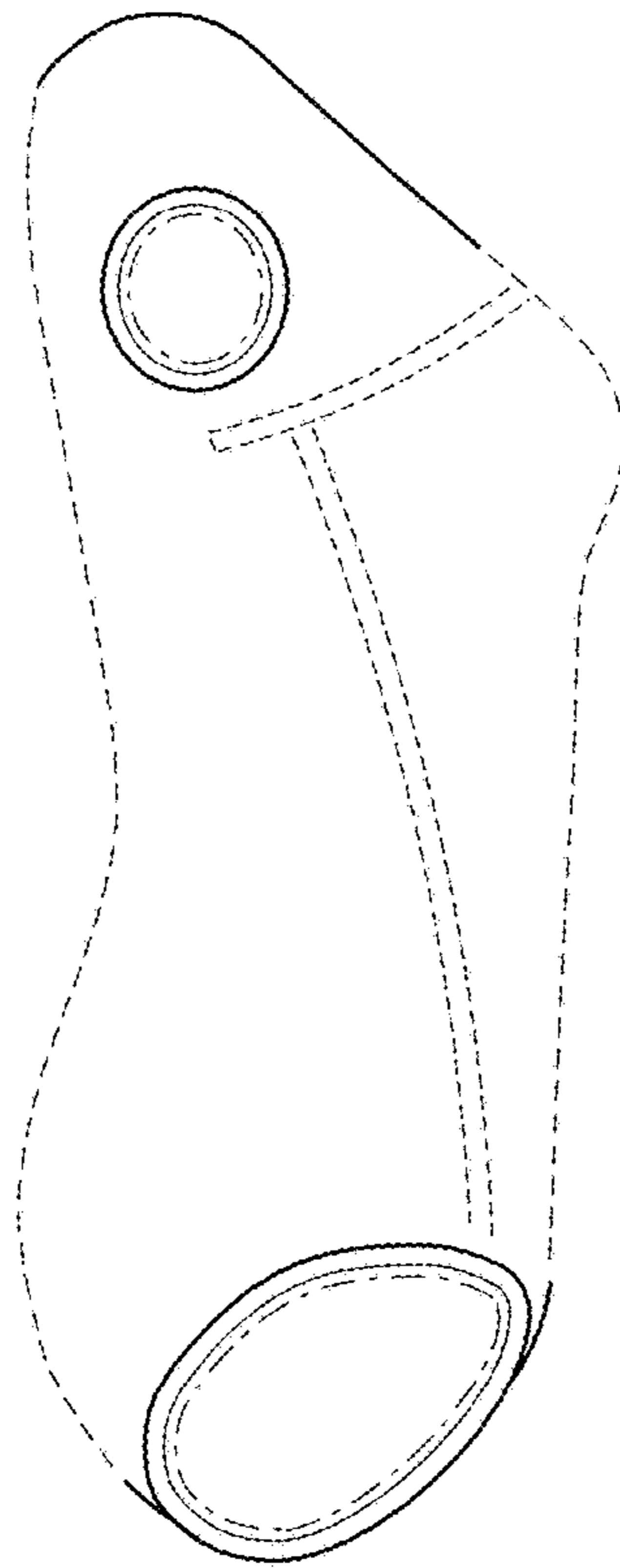

FIG. 11



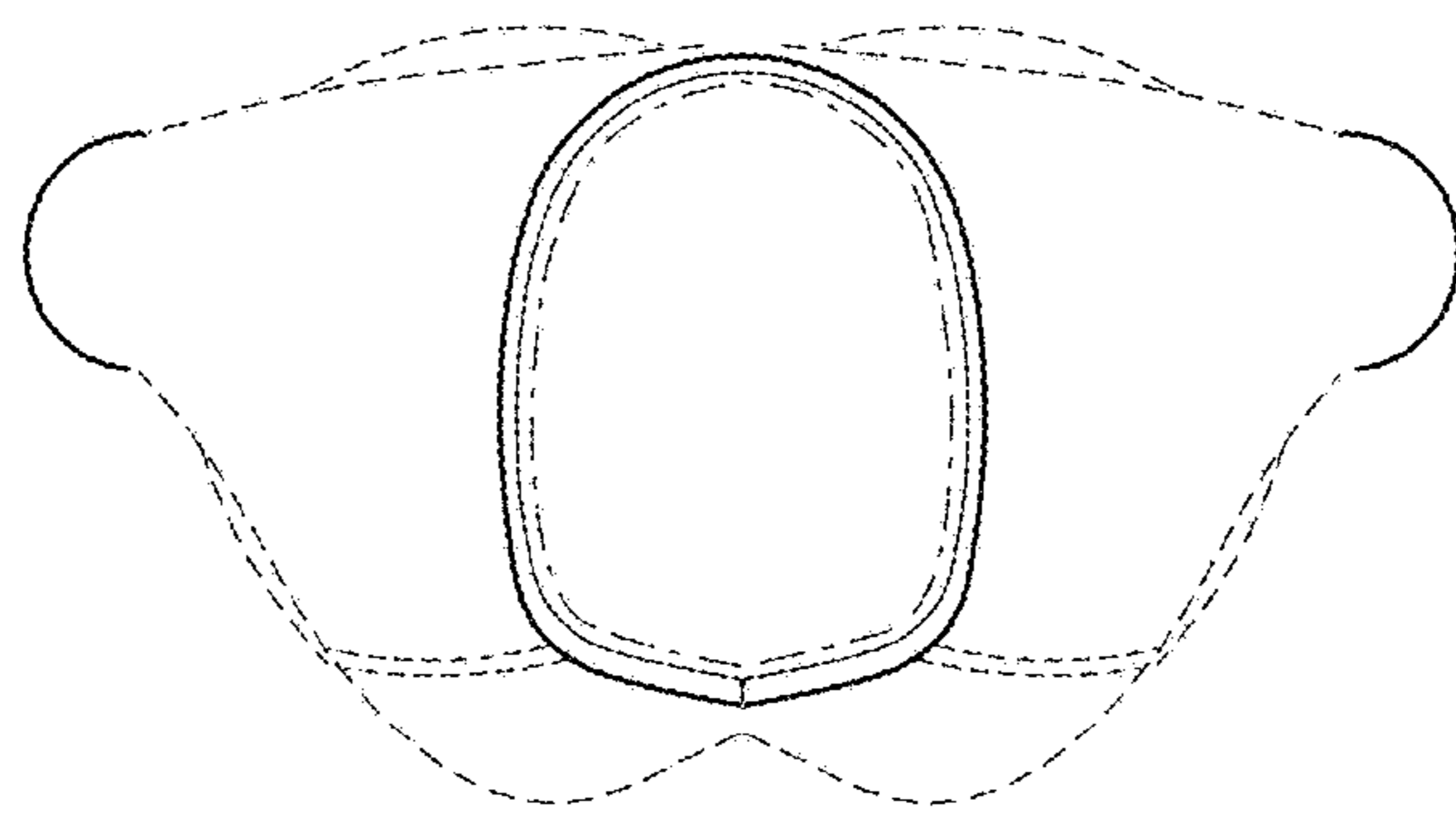

FIG. 12

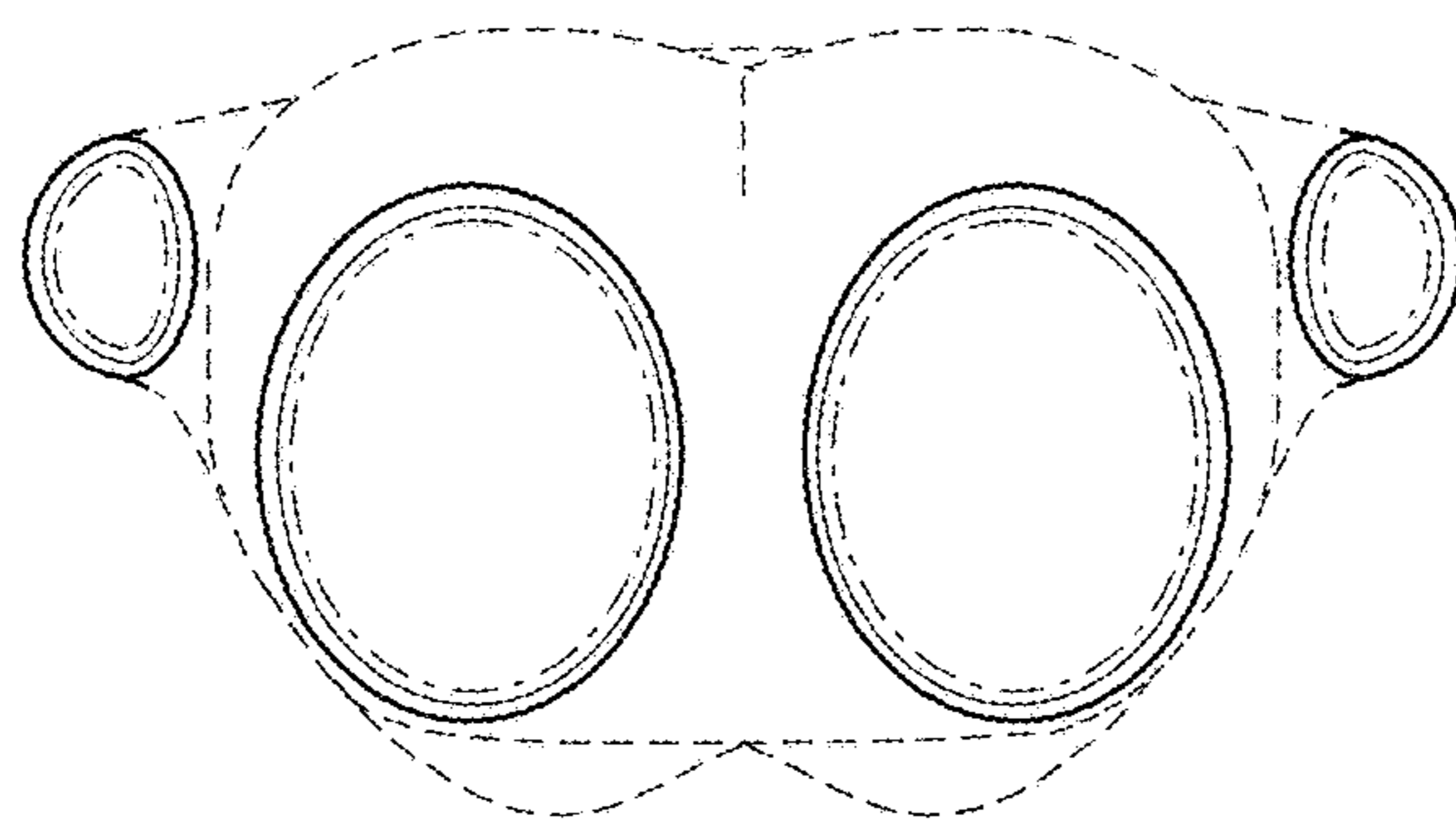

FIG. 13