



US00D866860S

(12) **United States Design Patent** (10) **Patent No.:** **US D866,860 S**
Dawson et al. (45) **Date of Patent:** **** Nov. 12, 2019**

(54) **HAIR TRIMMER DEVICE**
(71) Applicant: **Reckitt Benckiser (Brands) Limited**,
Slough (GB)
(72) Inventors: **Samuel Dawson**, Hull (GB); **Richard Gamble**, Slough (GB); **Jesse John Horne**, Warwickshire (GB); **Emma Raines**, Hull (GB); **David Sanders**, Warwickshire (GB)

D722,199 S * 2/2015 Boulanger D28/53
D799,752 S * 10/2017 Mori D28/53
D830,633 S * 10/2018 Gamble D28/53
D836,247 S * 12/2018 Van Maanen D28/44.1
2012/0192436 A1* 8/2012 Toy B26B 19/06
30/216

(Continued)

(73) Assignee: **RECKITT BENCKISER HEALTH LIMITED**, Slough (GB)

(**) Term: **15 Years**

(21) Appl. No.: **29/644,230**

(22) Filed: **Apr. 16, 2018**

(30) **Foreign Application Priority Data**

Oct. 19, 2017 (EM) 004411981-0004

(51) **LOC (12) Cl.** **28-03**

(52) **U.S. Cl.**
USPC **D28/53**

(58) **Field of Classification Search**
USPC D28/45-54
CPC ... B26B 21/00-12; B26B 21/14; B26B 21/16;
B26B 21/165; B26B 21/18; B26B 21/185;
B26B 21/20-227; B26B 19/00; B26B
19/10; B26B 19/12; B26B 19/14; B26B
19/38; B26B 19/02-107
See application file for complete search history.

(56) **References Cited**

U.S. PATENT DOCUMENTS

D495,833 S * 9/2004 McCambridge D28/53
D589,649 S * 3/2009 Tamsiran D28/44.1
D593,254 S * 5/2009 Tamsiran D28/51
D608,051 S * 1/2010 Tamsiran D28/44.1
D696,461 S * 12/2013 Prat-Pfister D28/53

OTHER PUBLICATIONS

Veet Sensitive Precision Beauty Styler Expert_ Veet, first available on Jan. 10, 2018 on amazon.co.uk, retrieved on Jul. 11, 2019, retrieved from the Internet URL: <https://www.amazon.co.uk/Veet-Sensitive-Precision-Beauty-Styler/dp/B078J39LBN>.*

(Continued)

Primary Examiner — Jennifer Rivard
Assistant Examiner — Alison M Ofstun

(74) *Attorney, Agent, or Firm* — Troutman Sanders LLP;
Ryan Schneider; Chris Davis

(57) **CLAIM**

The ornamental design for a hair trimmer device, as shown and described.

DESCRIPTION

FIG. 1 is a perspective view of the hair trimmer device showing our new design;
FIG. 2 is a front elevation view of the hair trimmer device of FIG. 1;
FIG. 3 is the side elevation view of the hair trimmer device of FIG. 1;
FIG. 4 is the back elevation view of the hair trimmer device of FIG. 1;
FIG. 5 is the other side elevation view of the hair trimmer device of FIG. 1;
FIG. 6 is a top plan view of the hair trimmer device of FIG. 1; and,
FIG. 7 is a bottom plan view of the hair trimmer device of FIG. 1.

1 Claim, 7 Drawing Sheets

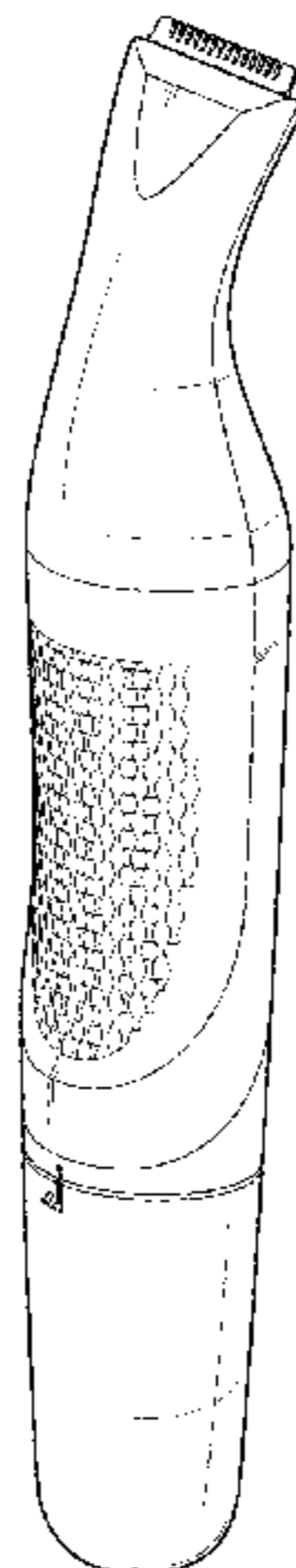

(56)

References Cited

U.S. PATENT DOCUMENTS

2018/0345510 A1* 12/2018 Julemont B26B 19/20

OTHER PUBLICATIONS

How to use Veet Sensitive Precision™ Beauty Styler?, VeetUK, published on Jul. 22, 2016 on youtube.com, retrieved on Jul. 11, 2019, retrieved from the Internet URL:.*

How to use the Veet Sensitive Precision Expert™, VeetUK, published on May 12, 2018, retrieved on Jul. 11, 2019, retrieved from the Internet URL: <https://www.youtube.com/watch?v=j7XijDYe6sE>.*

* cited by examiner

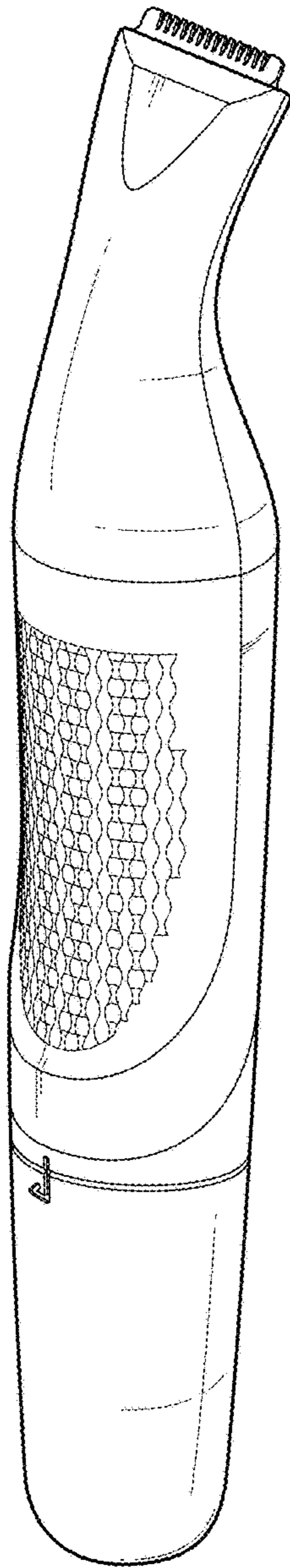

Fig. 1

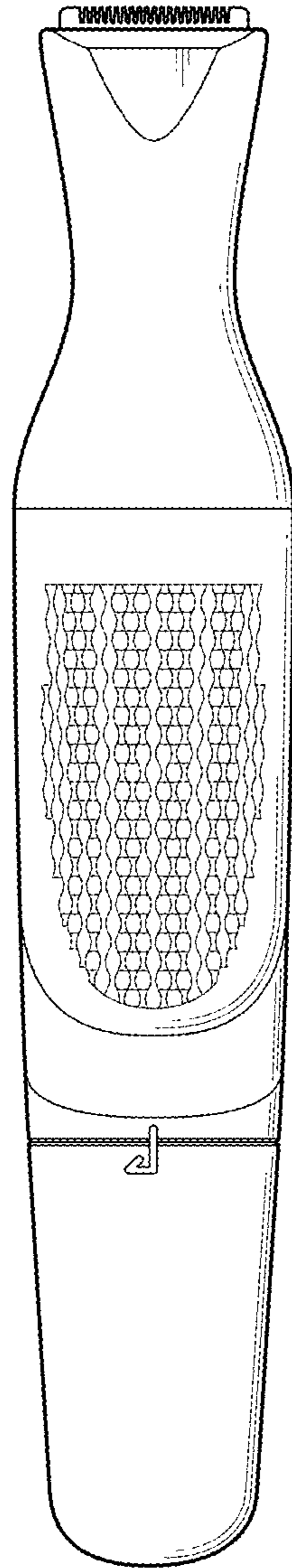

Fig. 2

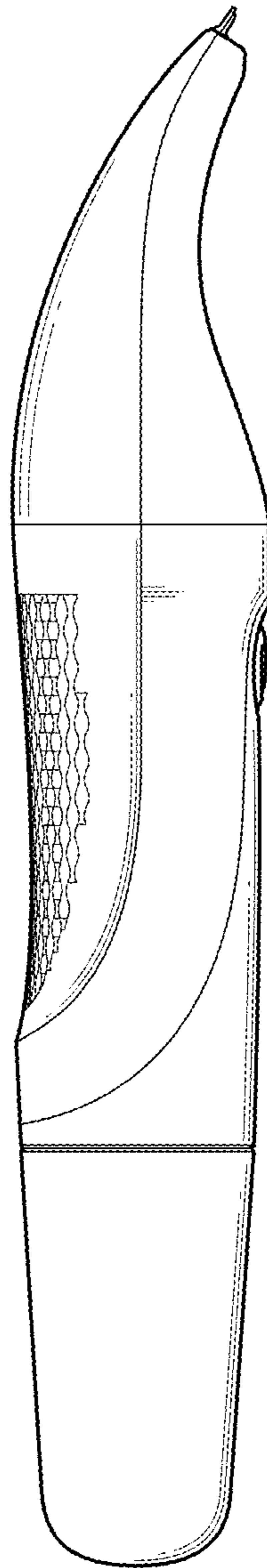

Fig. 3

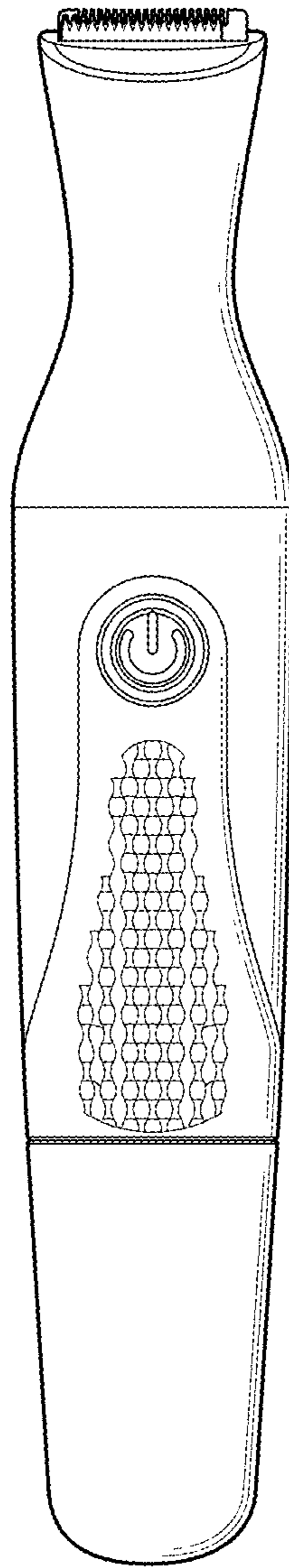

Fig. 4

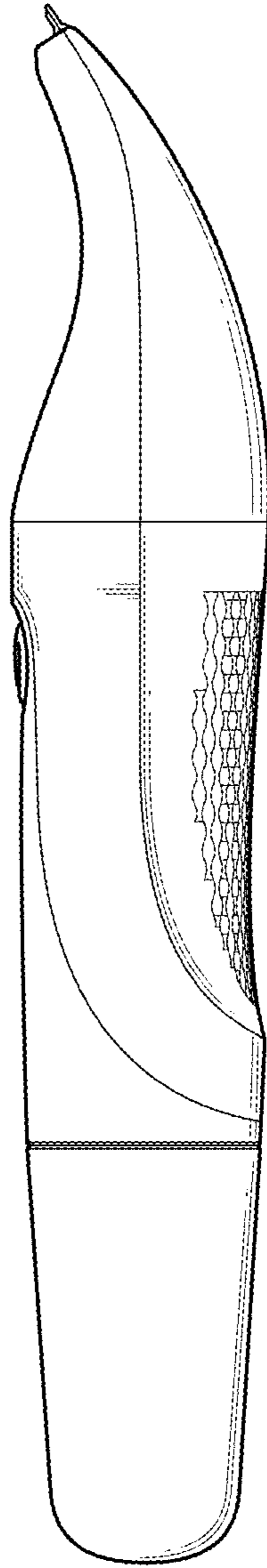

Fig. 5

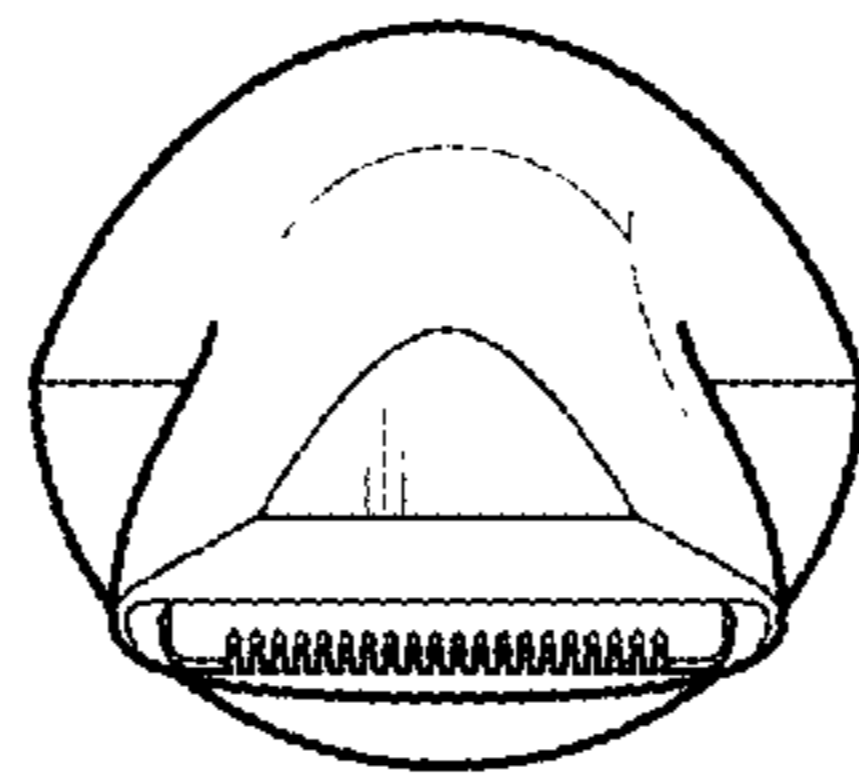

Fig. 6

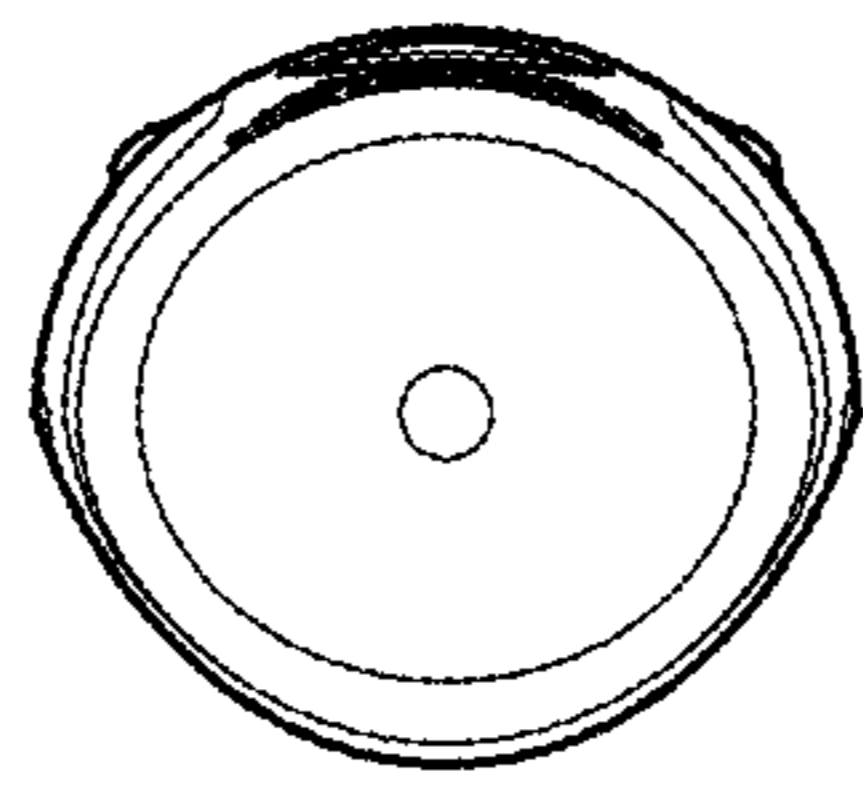

Fig. 7