



US00D866779S

(12) **United States Design Patent** (10) **Patent No.:** **US D866,779 S**
Liu (45) **Date of Patent:** **** *Nov. 12, 2019**

(54) **BEAUTY HEALTHCARE INSTRUMENT**

D571,926 S * 6/2008 Wu D24/215
8,386,032 B2 * 2/2013 Bachinski A61N 1/36021

(71) Applicant: **BIBOTING INTERNATIONAL CO., LTD.**, Taoyuan (TW)

D706,435 S * 6/2014 Weng D24/200

D733,899 S * 7/2015 Ferguson D24/200

(72) Inventor: **Shih-Ta Liu**, Taoyuan (TW)

D773,676 S * 12/2016 Gufler D24/200

D794,209 S * 8/2017 Hsieh D24/200

(73) Assignee: **BIBOTING INTERNATIONAL CO., LTD.**, Taoyuan (TW)

FOREIGN PATENT DOCUMENTS

(*) Notice: This patent is subject to a terminal disclaimer.

CN 304181178 * 10/2016

* cited by examiner

(**) Term: **15 Years**

Primary Examiner — Wan Laymon

(21) Appl. No.: **29/646,055**

(74) *Attorney, Agent, or Firm* — Rabin & Berdo, P.C.

(22) Filed: **May 1, 2018**

(51) **LOC (12) Cl.** **28-03**

(57) **CLAIM**

(52) **U.S. Cl.**
USPC **D24/200**

The ornamental design for a beauty healthcare instrument, as shown and described.

(58) **Field of Classification Search**
USPC D24/200, 214–215, 170, 186, 231;
607/108–111

CPC A61N 1/328; A61N 1/36; A61N 1/36021;
A61N 5/0616; A61N 2007/0034; A61H
7/00; A61H 7/001; A61H 7/003; A61H
7/004; A61H 7/005; A61H 7/007; A61H
7/008; A61H 15/0078; A61H 15/0085;
A61H 15/0092; A61H 39/002; A61H
39/00; A61H 2201/0153; A61H
2201/0157; A61H 2201/1253; A61H
2205/082

See application file for complete search history.

DESCRIPTION

FIG. 1 is a perspective view thereof of a beauty healthcare instrument showing my new design; FIG. 2 is a right side view thereof; FIG. 3 is a left side view thereof; FIG. 4 is a top plan view thereof; FIG. 5 is a bottom plan view thereof; FIG. 6 is a front view thereof; and, FIG. 7 is a rear view thereof.

The broken lines in the drawings are included to show unclaimed subject matter only and form no part of the claimed design.

(56) **References Cited**

U.S. PATENT DOCUMENTS

D364,928 S * 12/1995 Yamasaki D24/200
D539,916 S * 4/2007 Baldachini D24/200

1 Claim, 5 Drawing Sheets

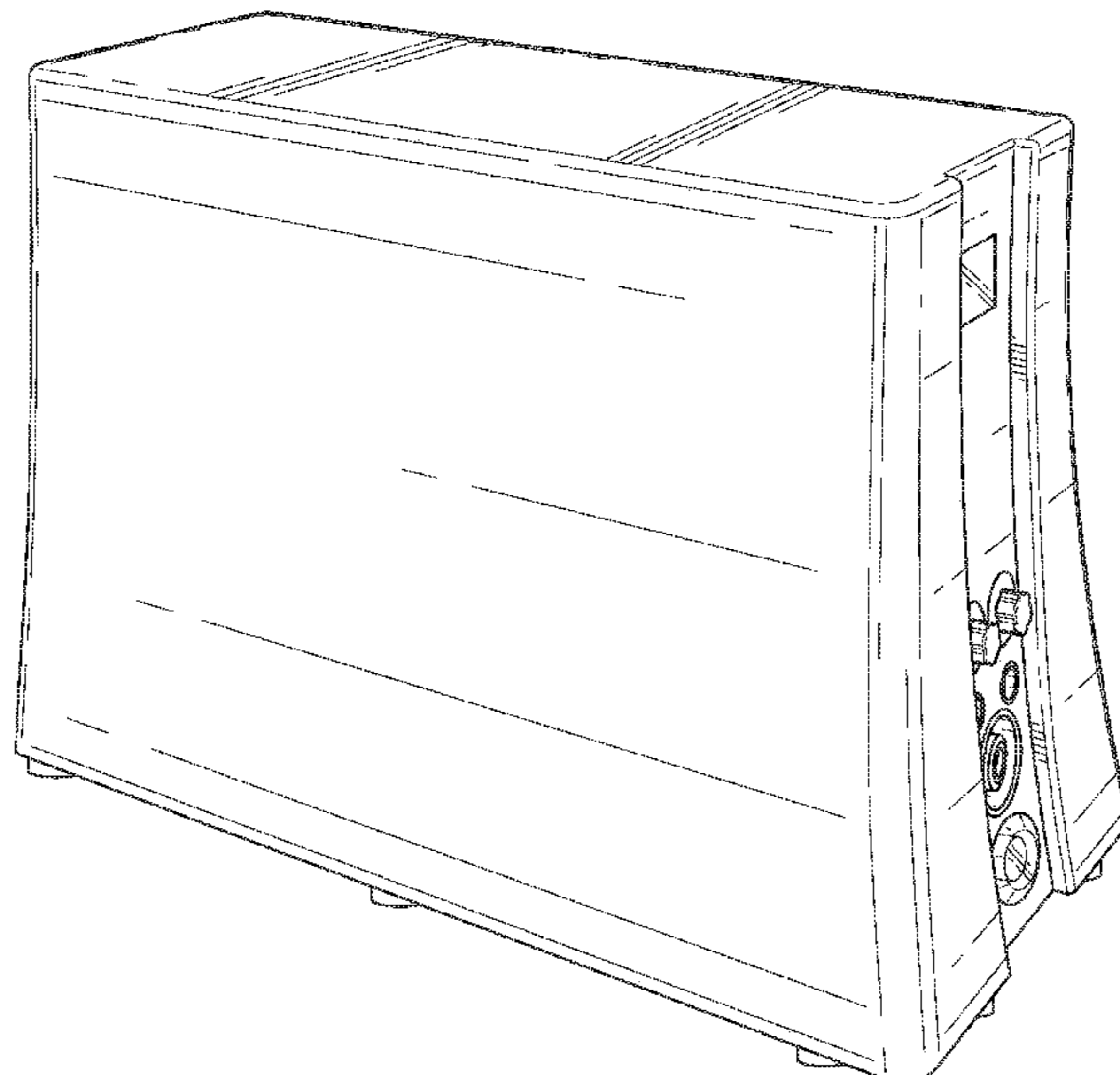

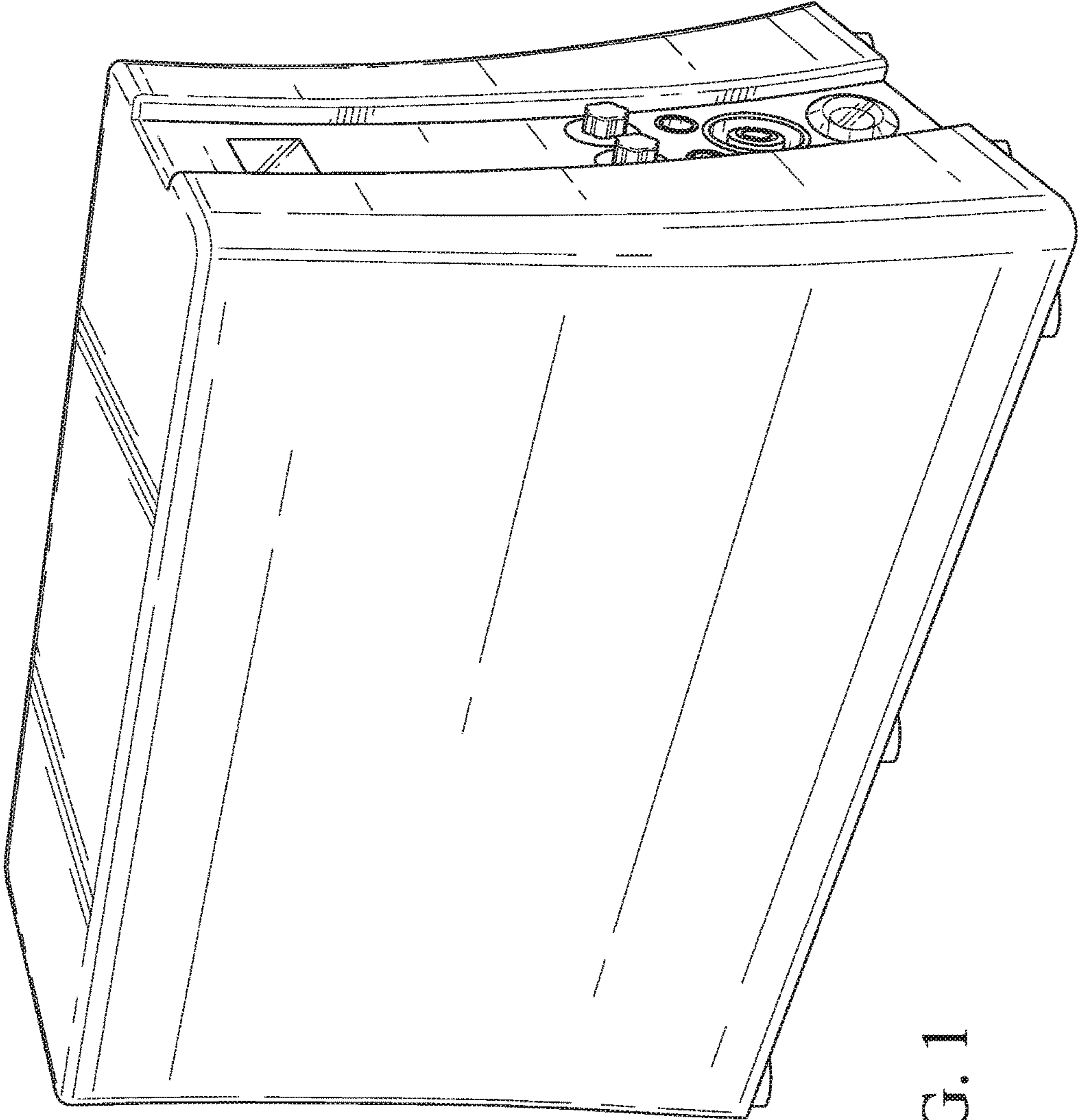

FIG. 1

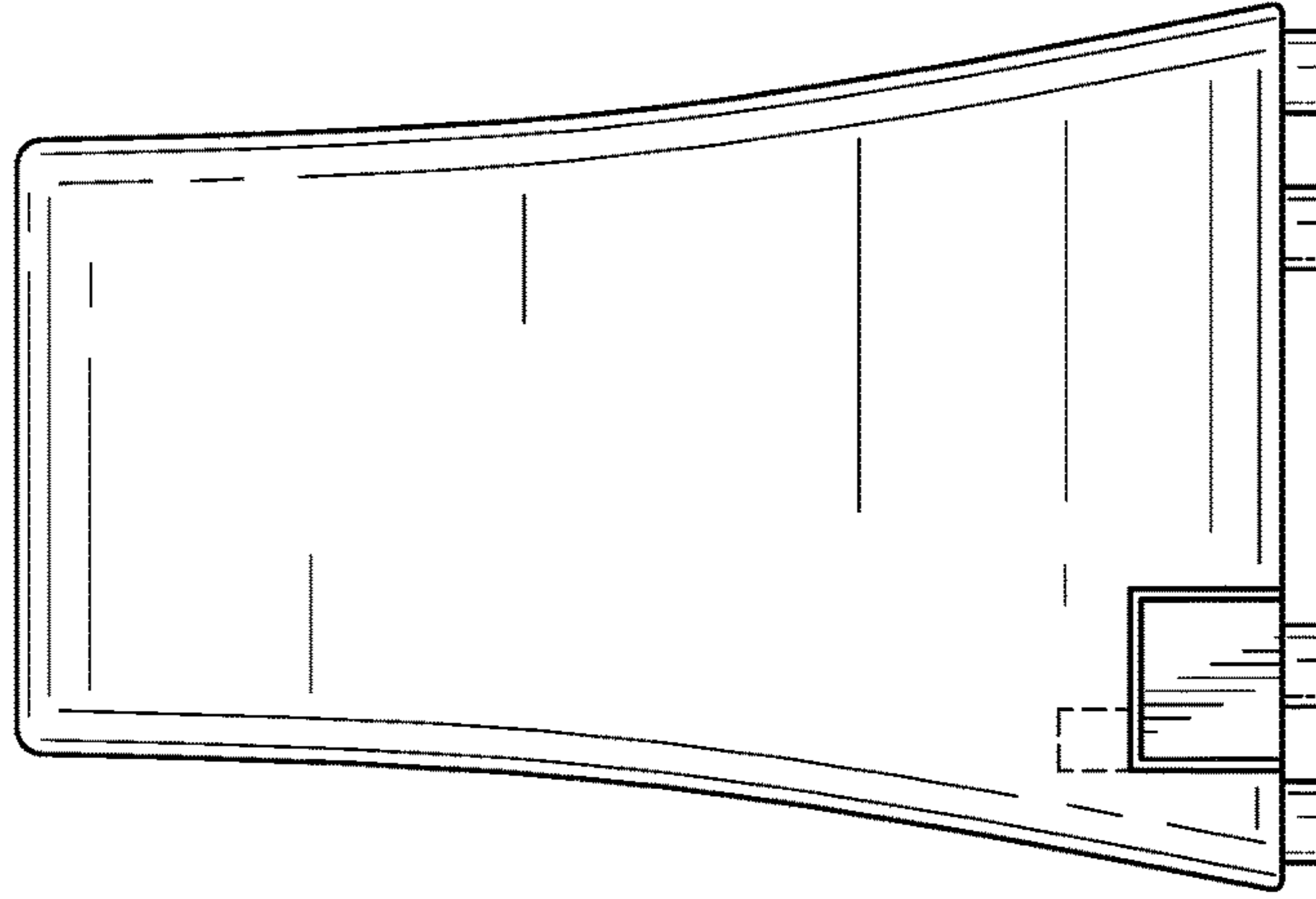

FIG. 3

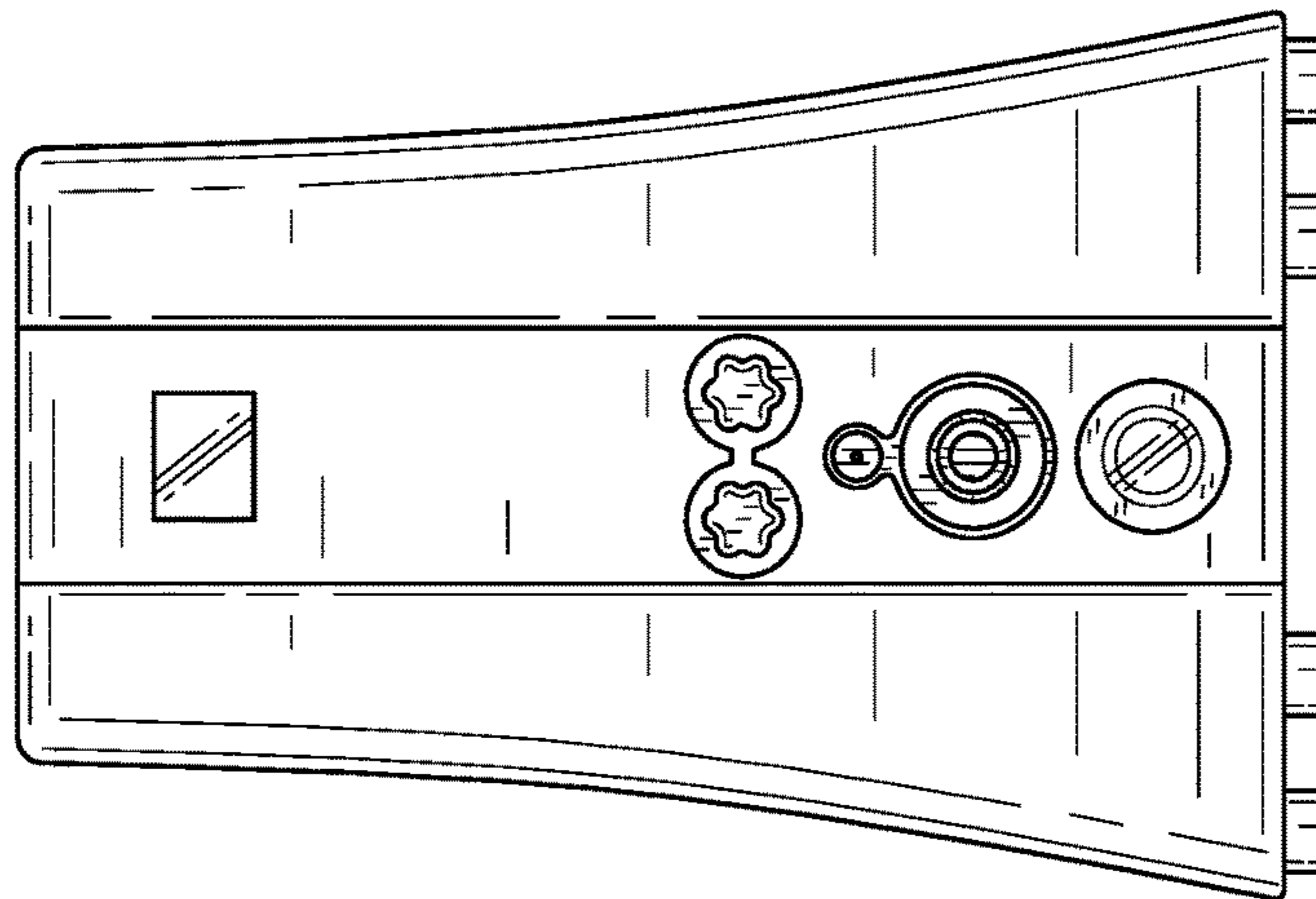

FIG. 2

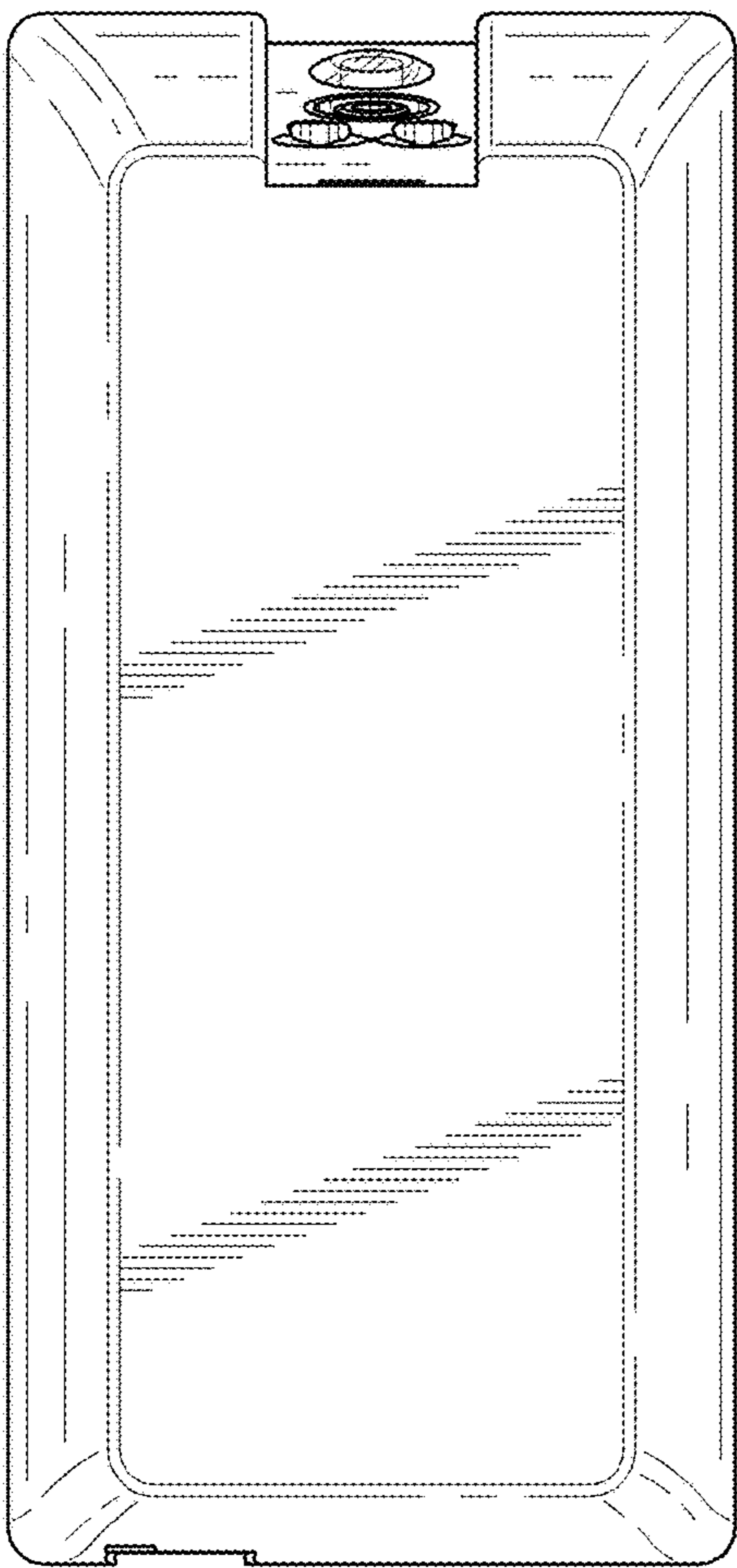

FIG. 4

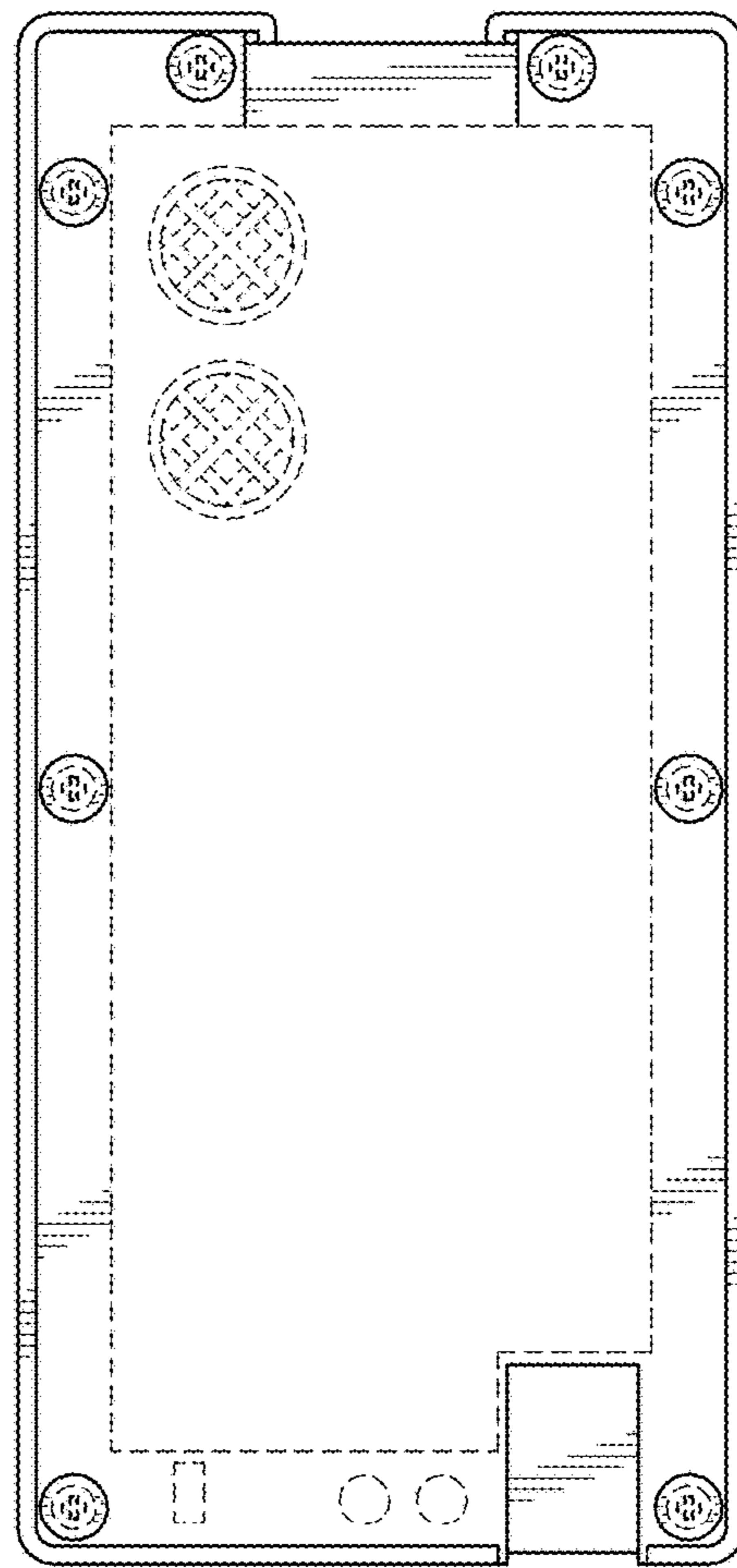

FIG. 5

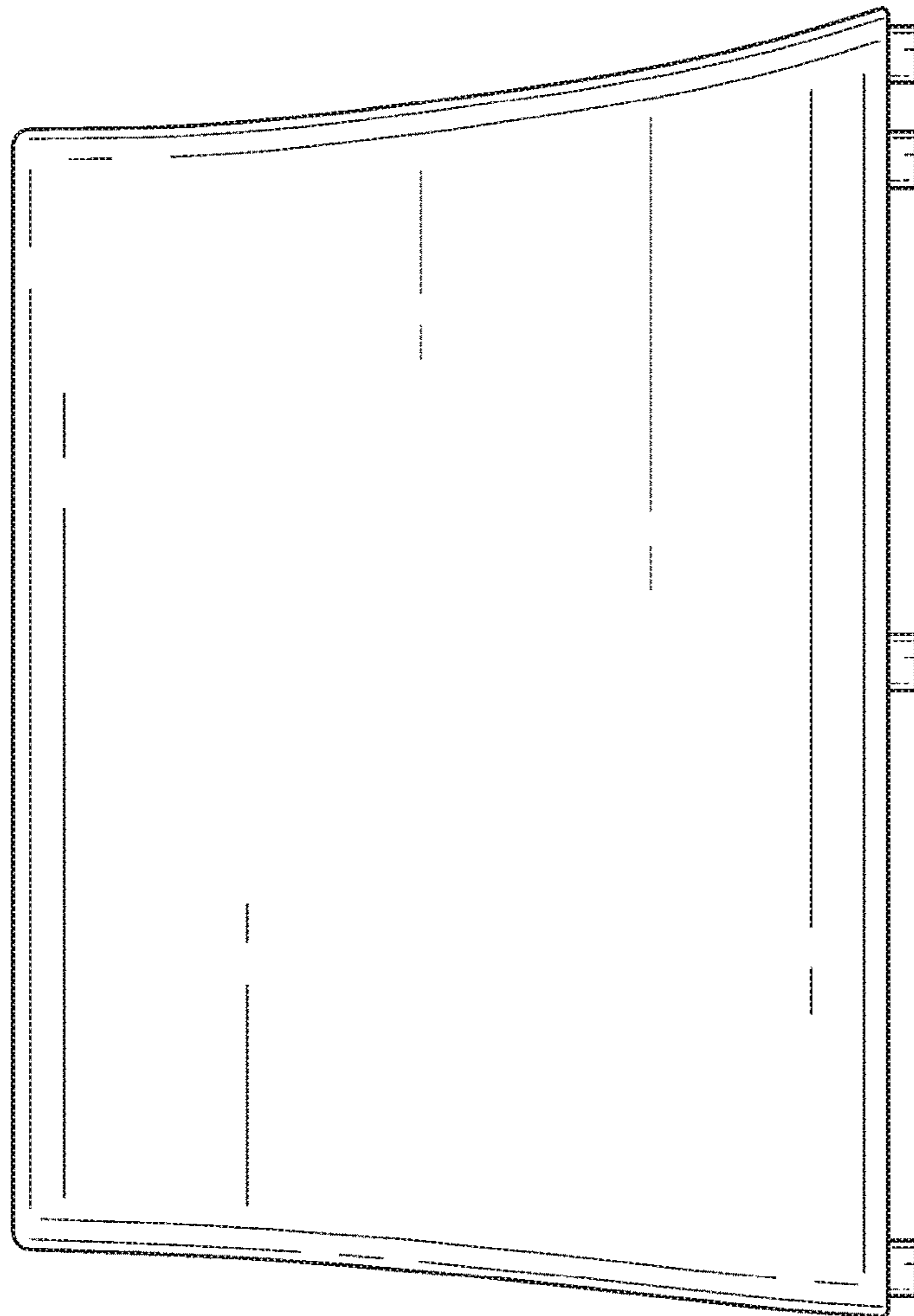

FIG. 6

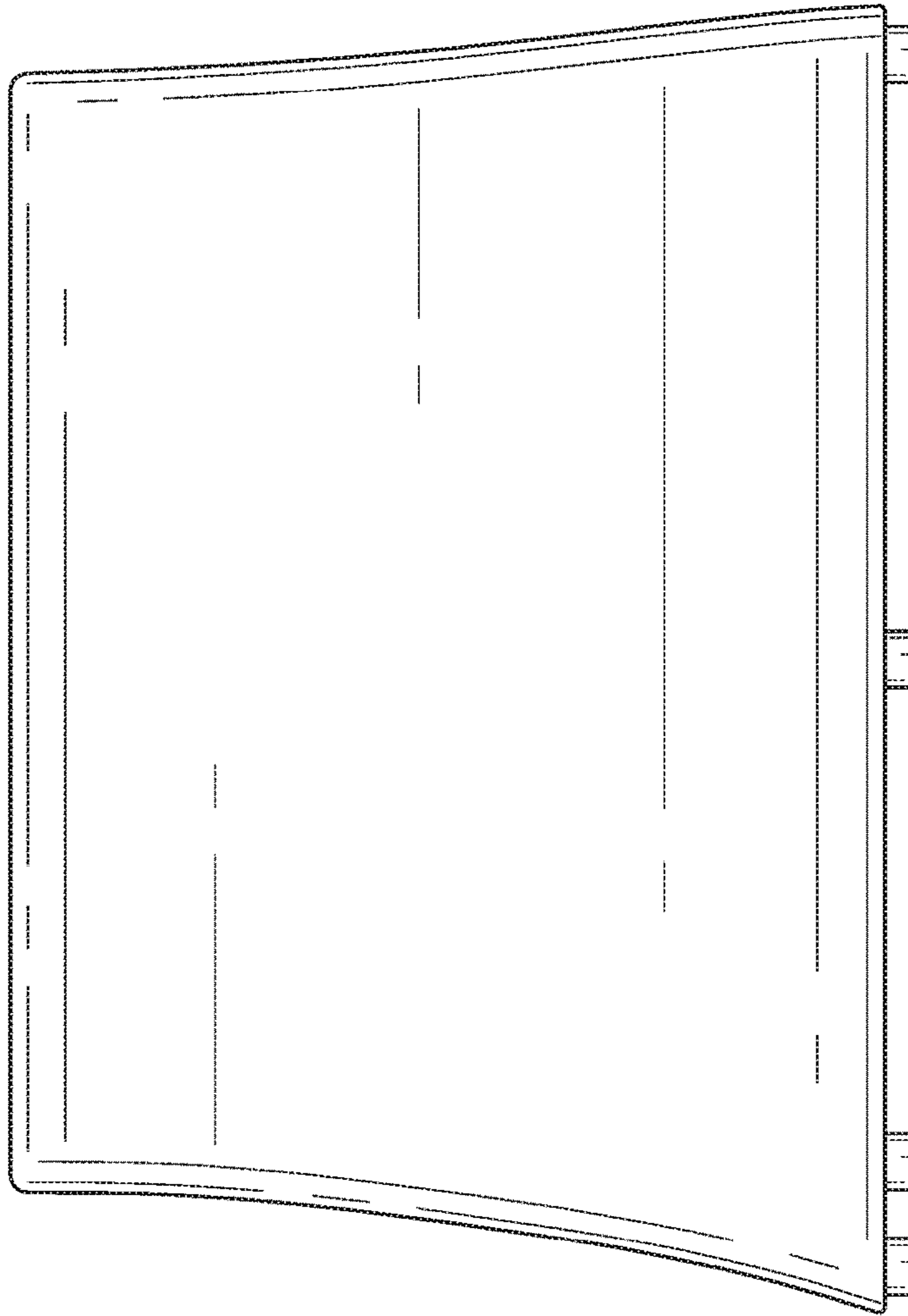

FIG. 7