

US00D866778S

(12) **United States Design Patent** (10) **Patent No.:** **US D866,778 S**
Liu (45) **Date of Patent:** **** *Nov. 12, 2019**

(54) **BEAUTY HEALTHCARE INSTRUMENT**

D571,926 S * 6/2008 Wu D24/215
8,386,032 B2 * 2/2013 Bachinski A61N 1/36021

(71) Applicant: **BIBOTING INTERNATIONAL CO. LTD.**, Taoyuan (TW)

D706,435 S * 6/2014 Weng D24/200

(72) Inventor: **Shih-Ta Liu**, Taoyuan (TW)

D733,899 S * 7/2015 Ferguson D24/200

D773,676 S * 12/2016 Gufler D24/200

D794,209 S * 8/2017 Hsieh D24/200

(73) Assignee: **BIBOTING INTERNATIONAL CO. LTD.**, Taoyuan (TW)

FOREIGN PATENT DOCUMENTS

(*) Notice: This patent is subject to a terminal disclaimer.

CN 304181178 * 10/2016

* cited by examiner

(**) Term: **15 Years**

Primary Examiner — Wan Laymon

(21) Appl. No.: **29/639,269**

(74) *Attorney, Agent, or Firm* — Rabin & Berdo, P.C.

(22) Filed: **Mar. 5, 2018**

(51) **LOC (12) Cl.** **28-03**

(57) **CLAIM**

(52) **U.S. Cl.**
USPC **D24/200**

The ornamental design for a beauty healthcare instrument, as shown and described.

(58) **Field of Classification Search**
USPC D24/200, 214–215, 170, 186, 231;
607/108–111

DESCRIPTION

CPC A61N 1/328; A61N 1/36; A61N 1/36021;
A61N 5/0616; A61N 2007/0034; A61H
7/00; A61H 7/001; A61H 7/003; A61H
7/004; A61H 7/005; A61H 7/007; A61H
7/008; A61H 15/0078; A61H 15/0085;
A61H 15/0092; A61H 39/002; A61H
39/00; A61H 2201/0153; A61H
2201/0157; A61H 2201/1253; A61H
2205/082

FIG. 1 is a perspective view thereof of a beauty healthcare instrument showing my new design;
FIG. 2 is a left side view thereof;
FIG. 3 is a right side view thereof;
FIG. 4 is a top plan view thereof;
FIG. 5 is a bottom plan view thereof;
FIG. 6 is a front view thereof; and,
FIG. 7 is a rear view thereof.

See application file for complete search history.

The broken lines in the drawings are included to show unclaimed subject matter only and form no part of the claimed design.

(56) **References Cited**

U.S. PATENT DOCUMENTS

D364,928 S * 12/1995 Yamasaki D24/200
D539,916 S * 4/2007 Baldachini D24/200

1 Claim, 5 Drawing Sheets

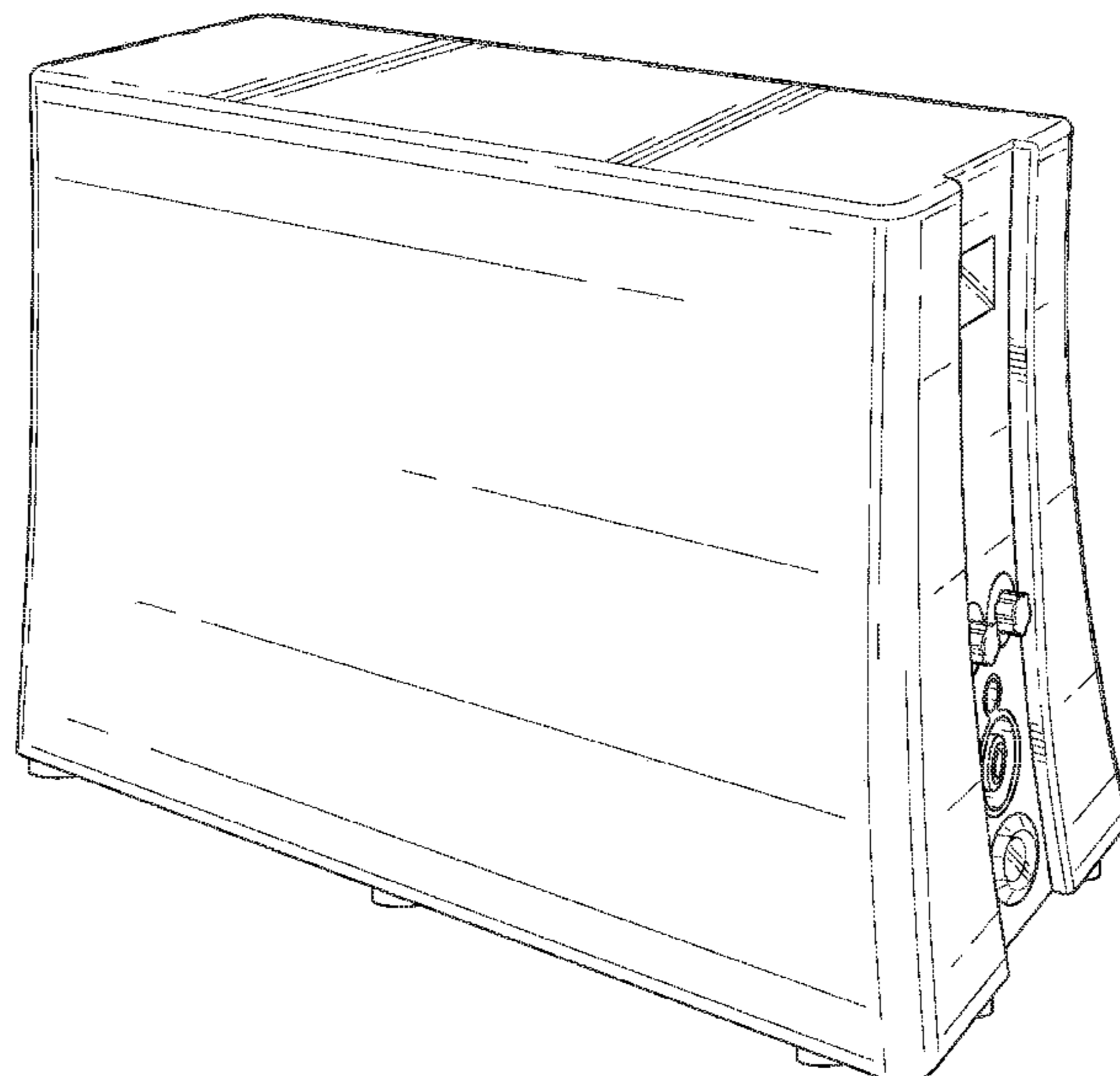

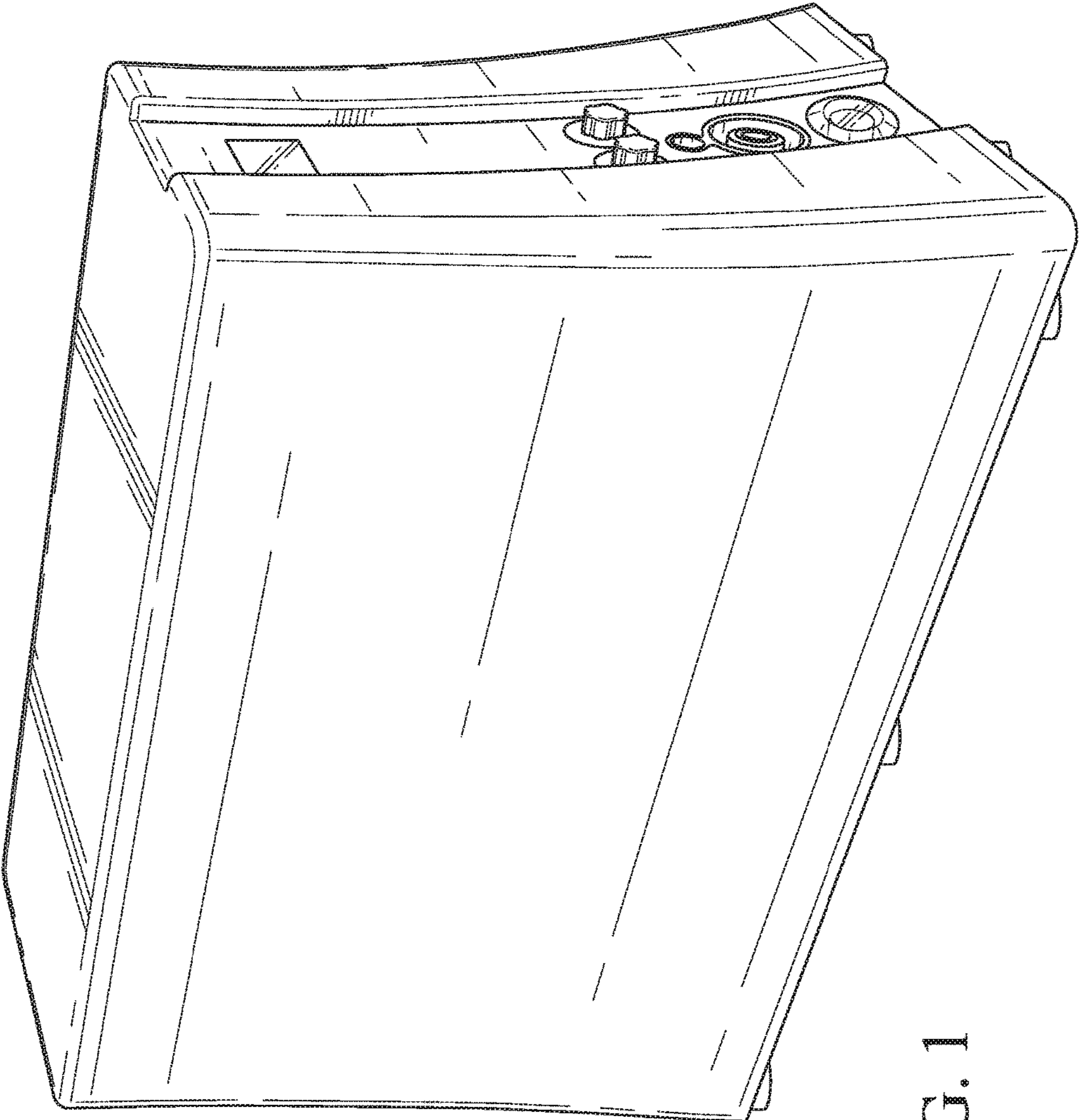

FIG. 1

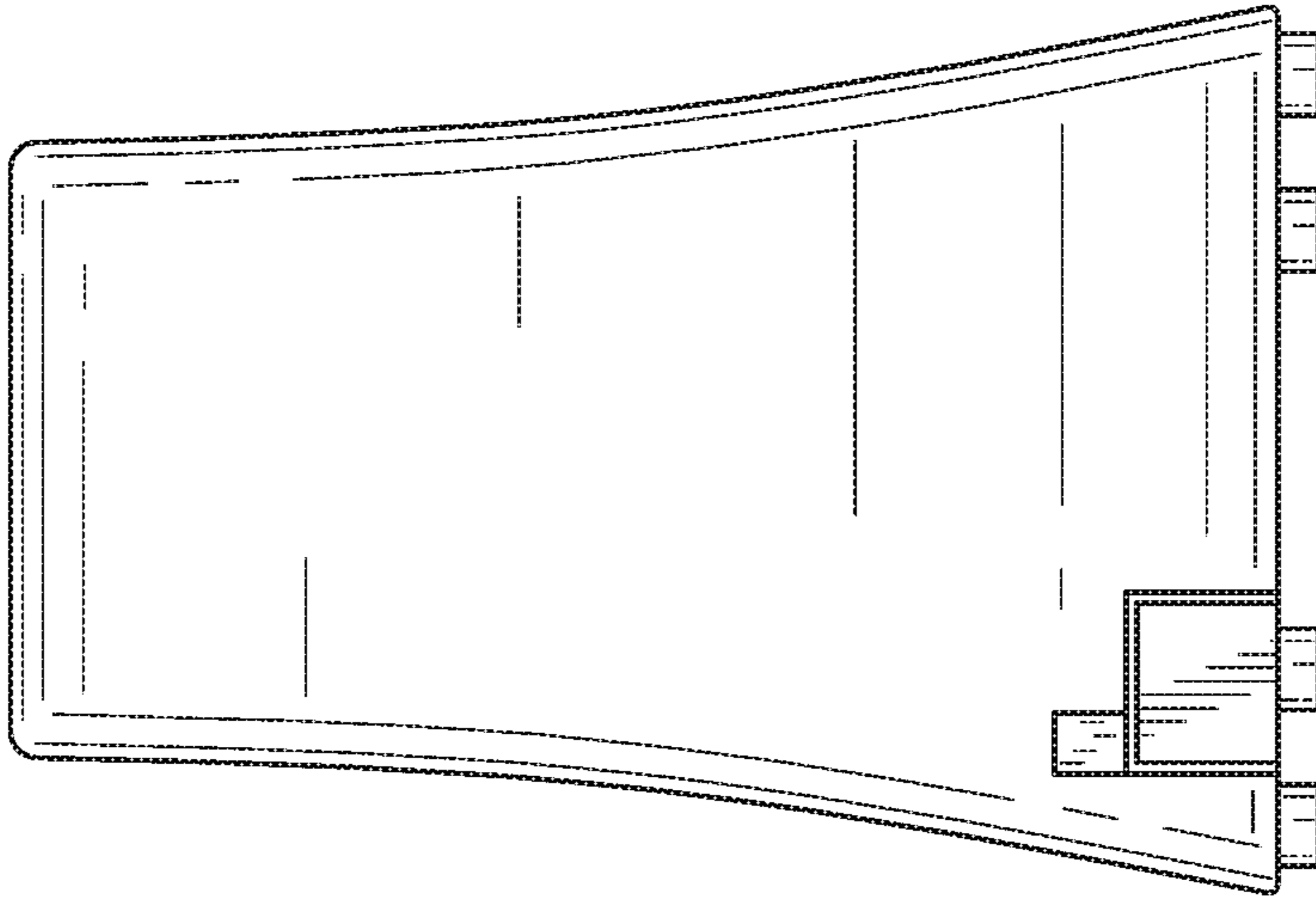

FIG. 2

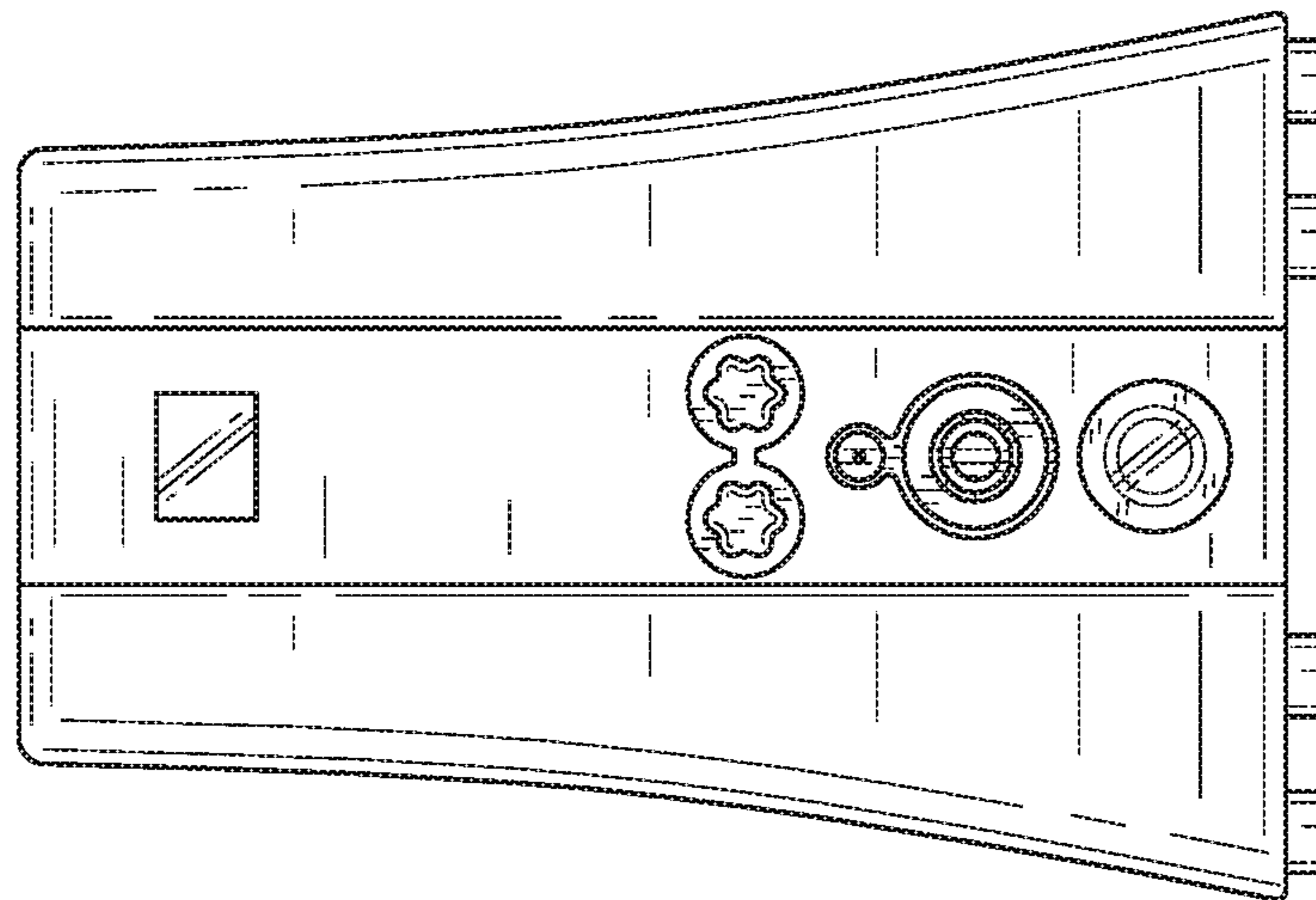

FIG. 3

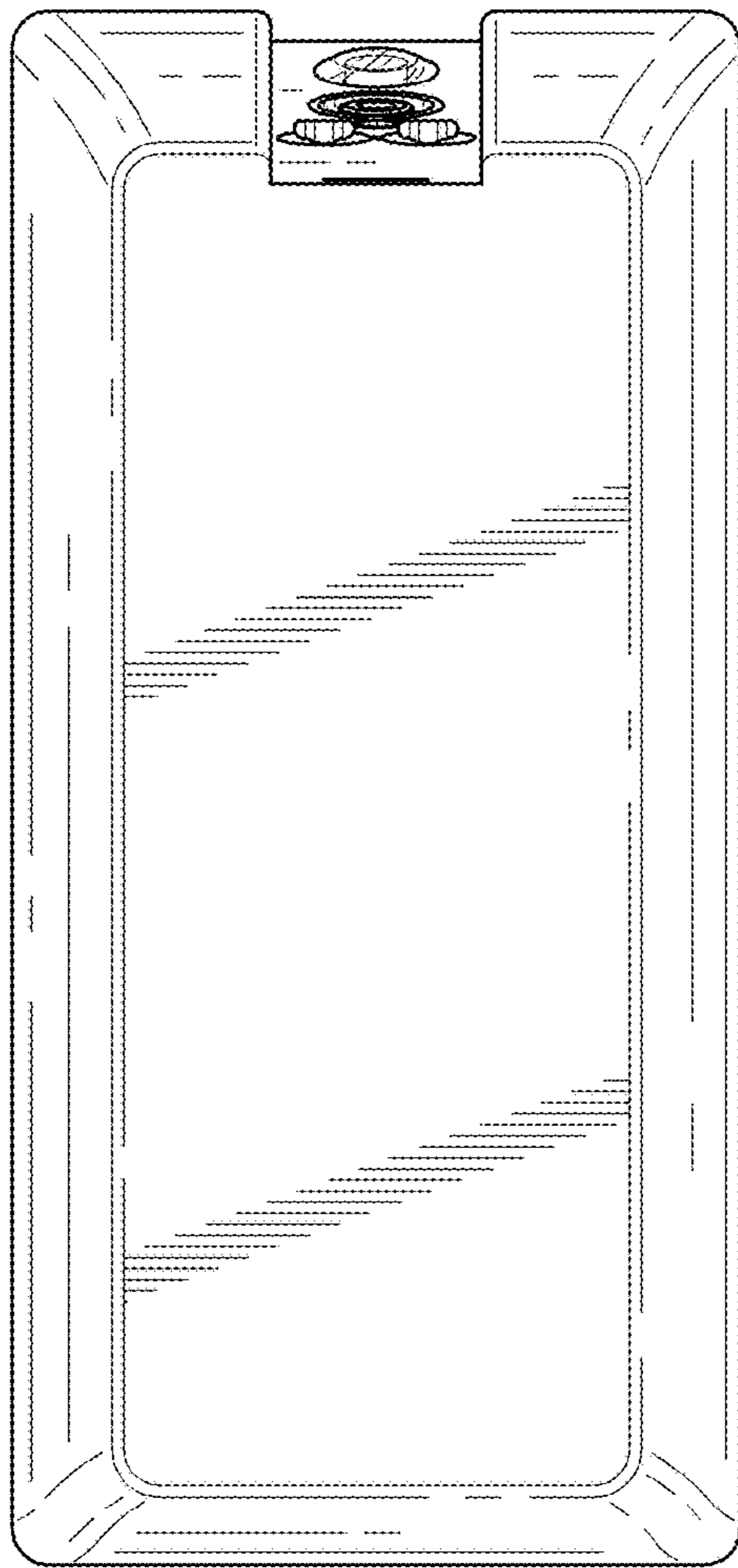

FIG. 4

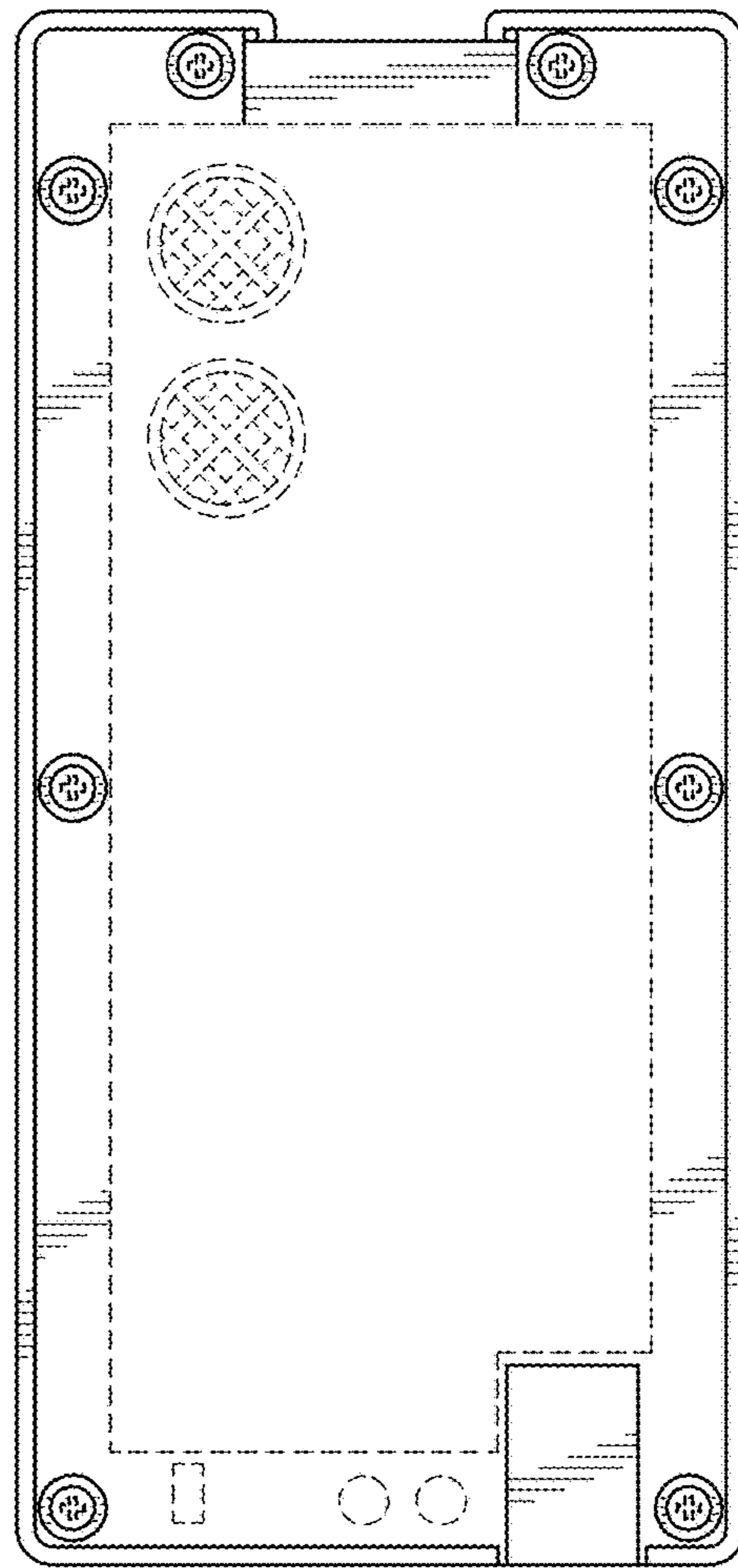

FIG. 5

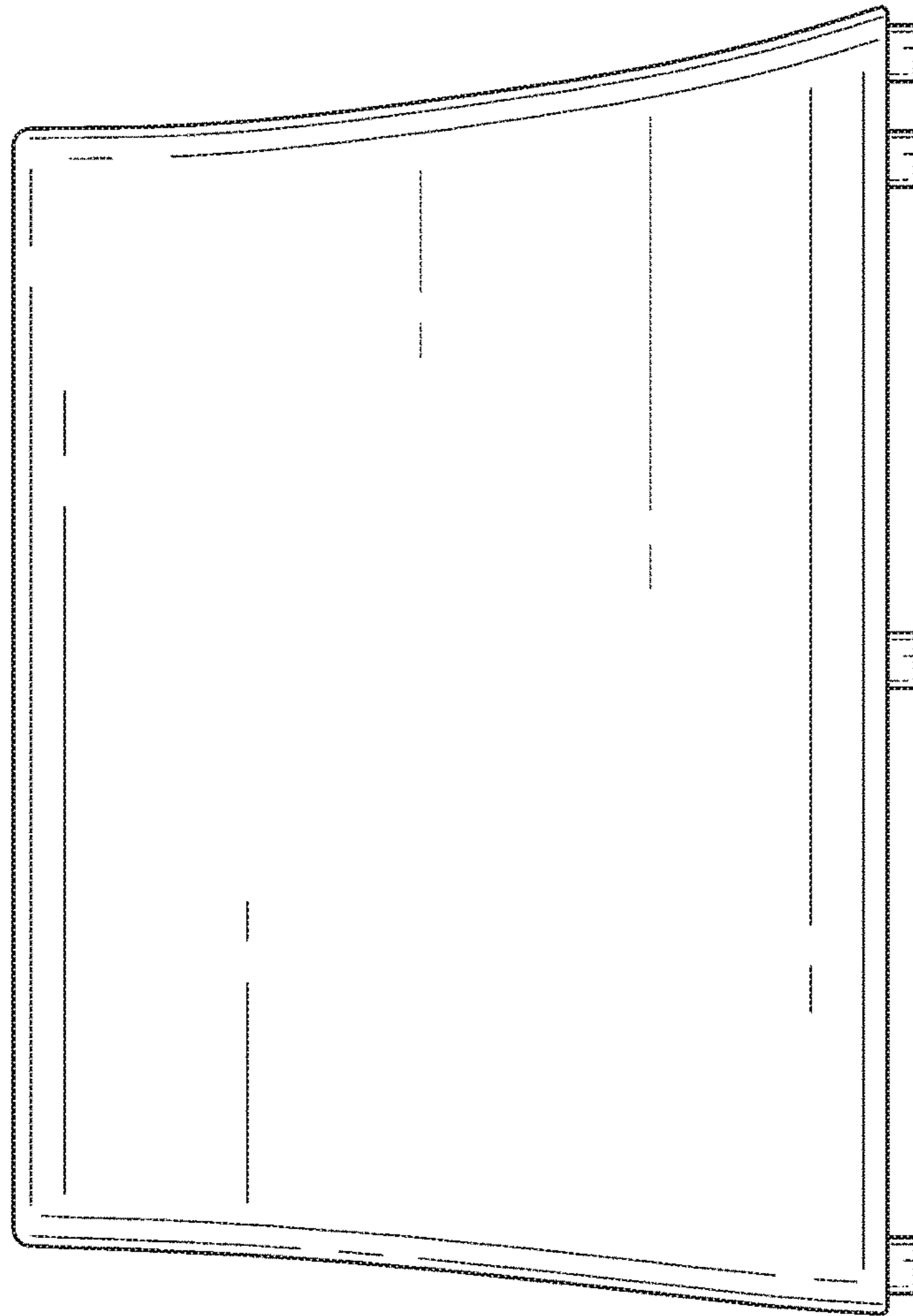

FIG. 6

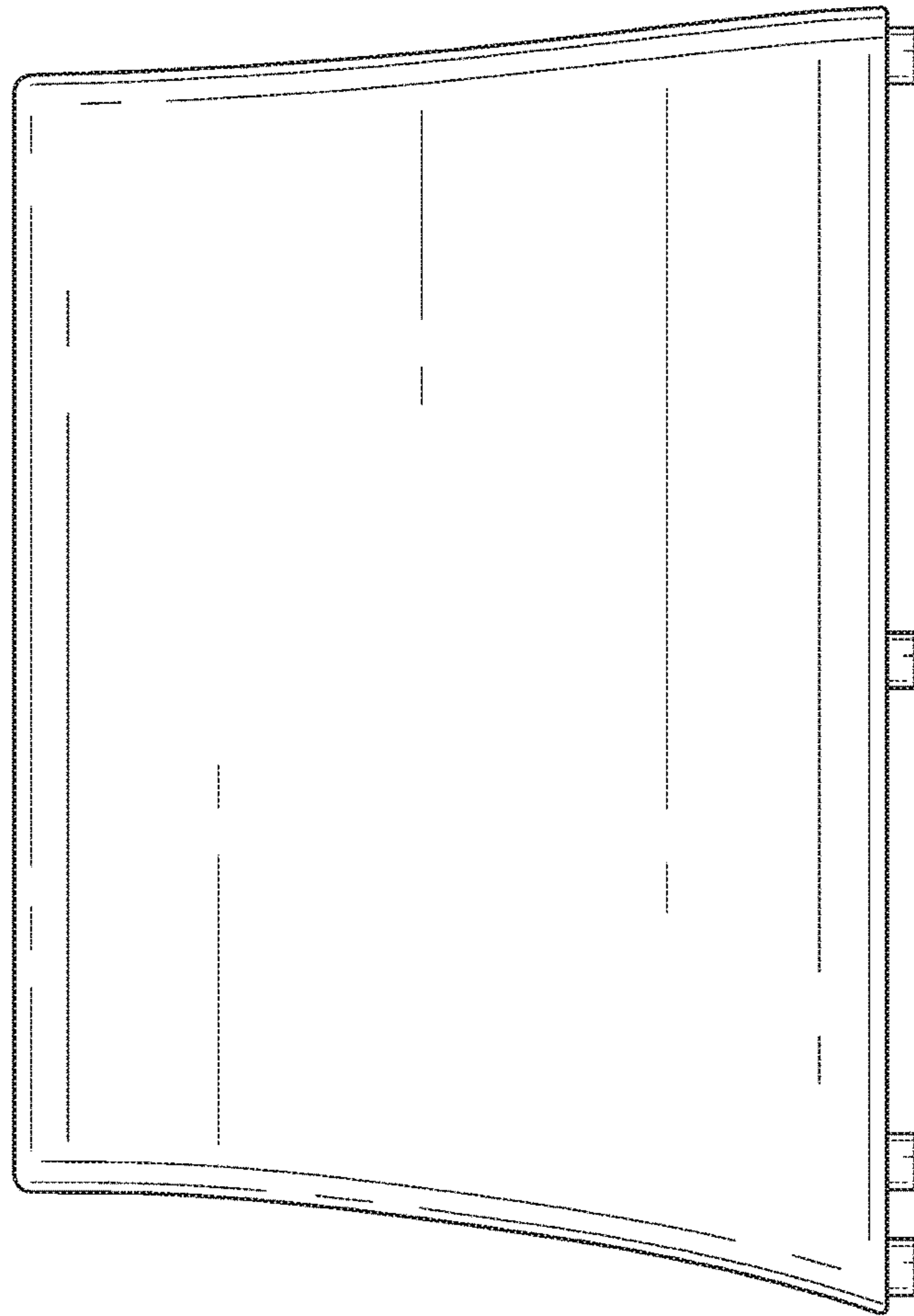

FIG. 7