



US00D866759S

(12) **United States Design Patent**  
**Opperman**

(10) **Patent No.:** **US D866,759 S**

(45) **Date of Patent:** **\*\* Nov. 12, 2019**

(54) **RETRACTOR**

(71) Applicant: **Colorado Voice Clinic, P.C.**, Denver,  
CO (US)

(72) Inventor: **David A. Opperman**, Littleton, CO  
(US)

(73) Assignee: **COLORADO VOICE CLINIC, P.C.**,  
Denver, CO (US)

(\*\*) Term: **15 Years**

(21) Appl. No.: **29/628,152**

(22) Filed: **Dec. 1, 2017**

**Related U.S. Application Data**

(63) Continuation-in-part of application No. 15/457,404,  
filed on Mar. 13, 2017, now Pat. No. 10,238,373.

(51) **LOC (12) Cl.** ..... **24-02**

(52) **U.S. Cl.**  
USPC ..... **D24/135**

(58) **Field of Classification Search**

USPC ..... D24/133, 135, 136, 140, 143, 150, 152,  
D24/171, 172, 176, 231, 107, 108, 111,  
D24/112, 120, 167; D8/47, 48, 82, 83,  
D8/88, 89, 16-19, 3; D19/37, 158;  
D13/144; D29/113, 121.1, 114;  
D21/793; D26/56

CPC ..... A61B 17/17; A61B 17/02; A61B 17/0206;  
A61B 17/0293; A61B 17/0231; A61B  
2017/0256; A61B 2017/0237; A61B  
2017/0268; A61B 2017/0275; A61B 1/32;  
A61B 17/24; A61B 1/267; A61M 16/0488

See application file for complete search history.

(56) **References Cited**

**U.S. PATENT DOCUMENTS**

471,221 A \* 3/1892 Moores ..... A61F 13/105  
294/25  
2,131,372 A \* 9/1938 Flood ..... G09F 3/14  
40/668

2,152,349 A \* 3/1939 Flood ..... G09F 3/14  
24/715.4  
2,225,571 A \* 12/1940 Smith ..... A41D 13/087  
2/21  
D168,363 S \* 12/1952 Martin ..... D24/135  
3,070,804 A \* 1/1963 Parrilla ..... A45D 31/00  
2/21  
D220,855 S \* 6/1971 Duval ..... D24/136  
4,384,570 A \* 5/1983 Roberts  
D270,183 S \* 8/1983 Govenius ..... D24/112

(Continued)

**OTHER PUBLICATIONS**

Olympus FK-WO TORS Laryngo-pharyngoscope retractor. <http://olympusmedical.com/sg/products/all-products/instruments/ent-instruments/fk-wo-tors-laryngo-pharyngoscope-retractor/index.html>. Retrieved from the internet Mar. 2016. 3 pages.

*Primary Examiner* — Jeffrey D Asch

*Assistant Examiner* — Tracey J Bell

(74) *Attorney, Agent, or Firm* — Lewis, Brisbois,  
Bisgaard & Smith LLP; Craig W. Mueller

(57) **CLAIM**

The ornamental design for a retractor, as shown and described.

**DESCRIPTION**

FIG. 1 is a perspective view of a retractor showing the new design;

FIG. 2 is a front elevation view thereof;

FIG. 3 is a rear elevation view thereof;

FIG. 4 is a right elevation view thereof;

FIG. 5 is a left elevation view thereof;

FIG. 6 is a top plan view thereof; and,

FIG. 7 is a bottom plan view thereof.

The broken lines depict environment and form no part of the claimed design.

**1 Claim, 5 Drawing Sheets**

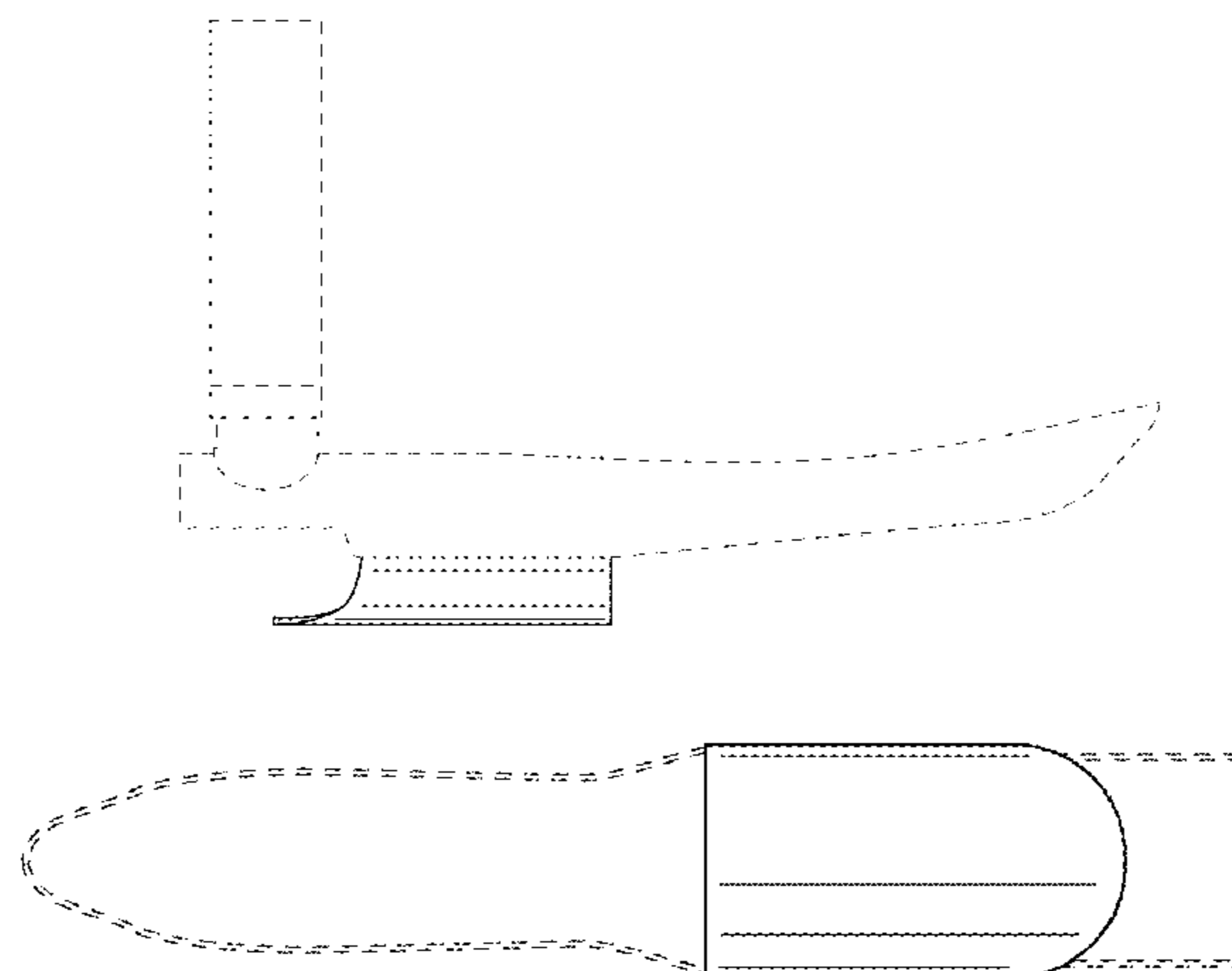

(56)

References Cited

U.S. PATENT DOCUMENTS

4,705,024 A \* 11/1987 Bainton ..... A61B 1/267  
600/194  
D309,196 S \* 7/1990 LaJoie ..... D28/56  
D314,727 S \* 2/1991 Samaras ..... D11/27  
5,092,314 A 3/1992 Zeitels  
D334,085 S \* 3/1993 Niemann ..... D29/113  
D338,240 S \* 8/1993 Mori ..... D20/22  
D338,688 S \* 8/1993 Mori ..... D20/22  
5,450,626 A \* 9/1995 Sorrels ..... A41D 13/087  
2/163  
D373,656 S \* 9/1996 Sorrels ..... D29/114  
D438,979 S \* 3/2001 Gomes ..... D24/130  
D486,908 S \* 2/2004 Himbert ..... D24/113  
6,955,645 B1 10/2005 Zeitels  
D540,945 S \* 4/2007 Darnold ..... D24/133  
D545,503 S \* 6/2007 Ryscavage ..... D29/114  
D558,347 S \* 12/2007 Darnold ..... D24/152  
D629,897 S \* 12/2010 Koros ..... D24/135  
D685,087 S \* 6/2013 Voic ..... D24/133  
D701,135 S \* 3/2014 Penner ..... D11/27  
D702,402 S \* 4/2014 Pew ..... D29/113  
D718,862 S \* 12/2014 Matheny ..... D24/155  
D779,665 S \* 2/2017 Hasbun ..... D24/135  
2005/0054972 A1 \* 3/2005 Adams ..... A61B 17/1688  
604/22  
2018/0110403 A1 \* 4/2018 Okazaki ..... A61B 1/00  
2018/0110503 A1 \* 4/2018 Flock ..... A61B 17/025

\* cited by examiner

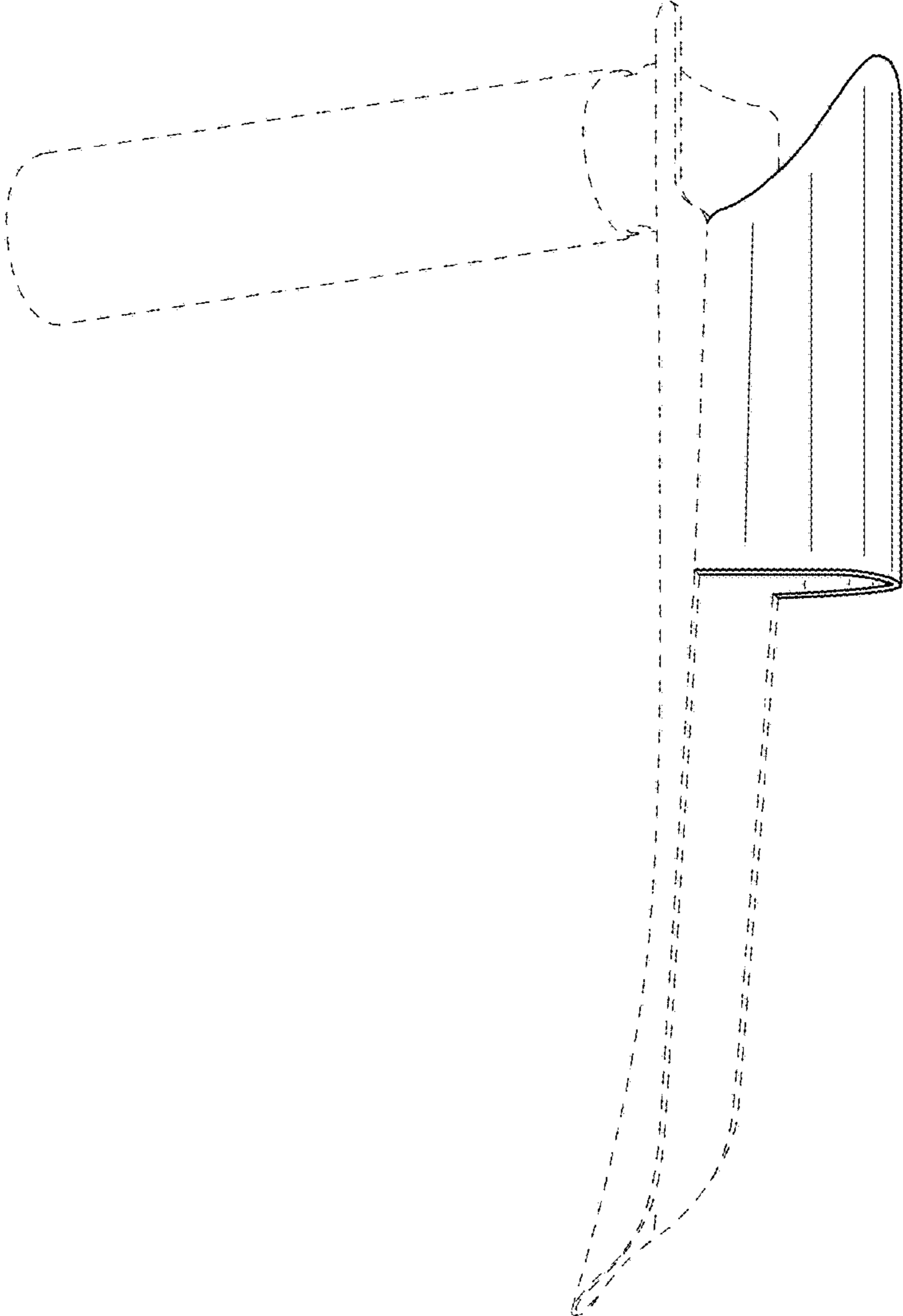

FIG.1

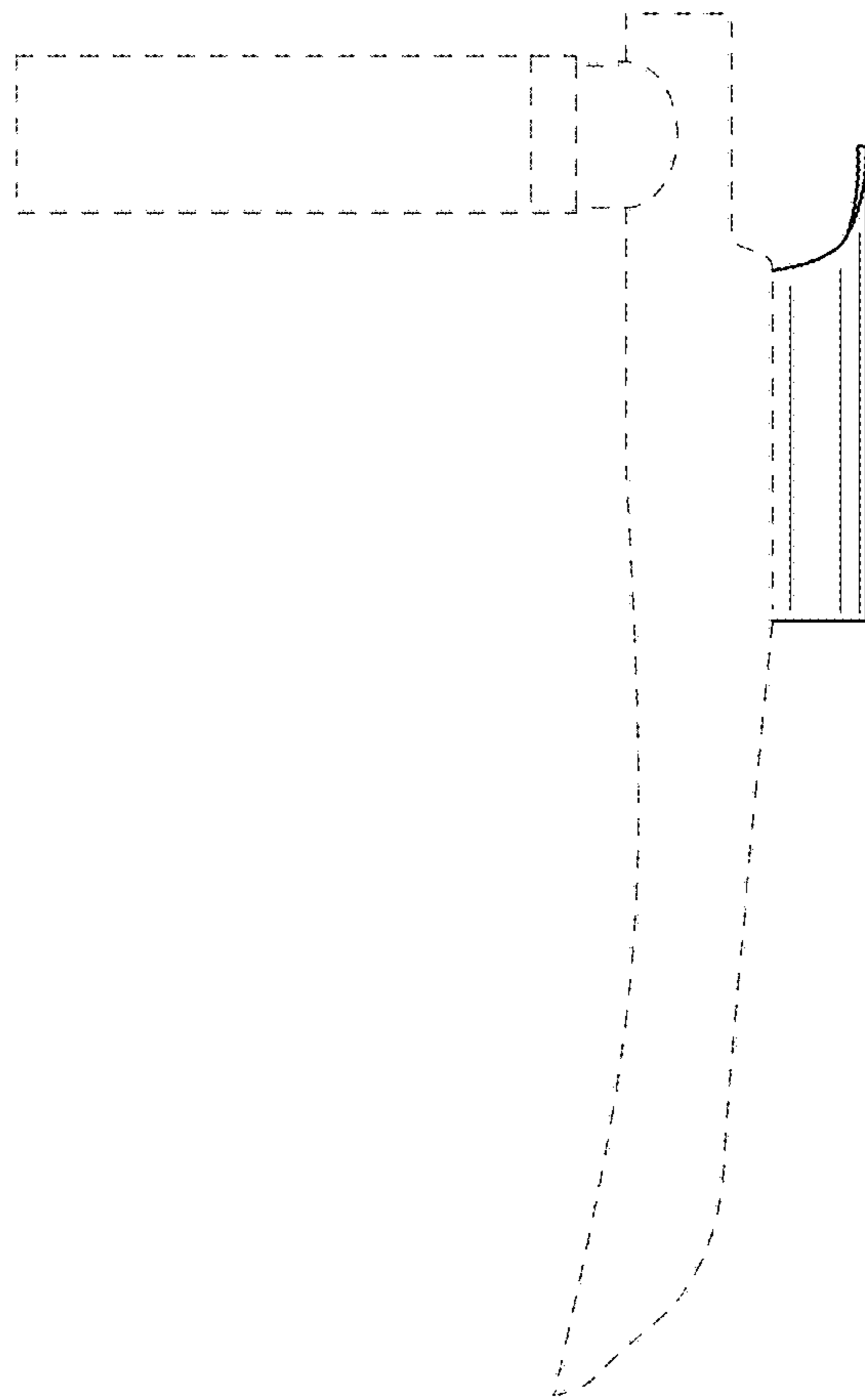

FIG.2

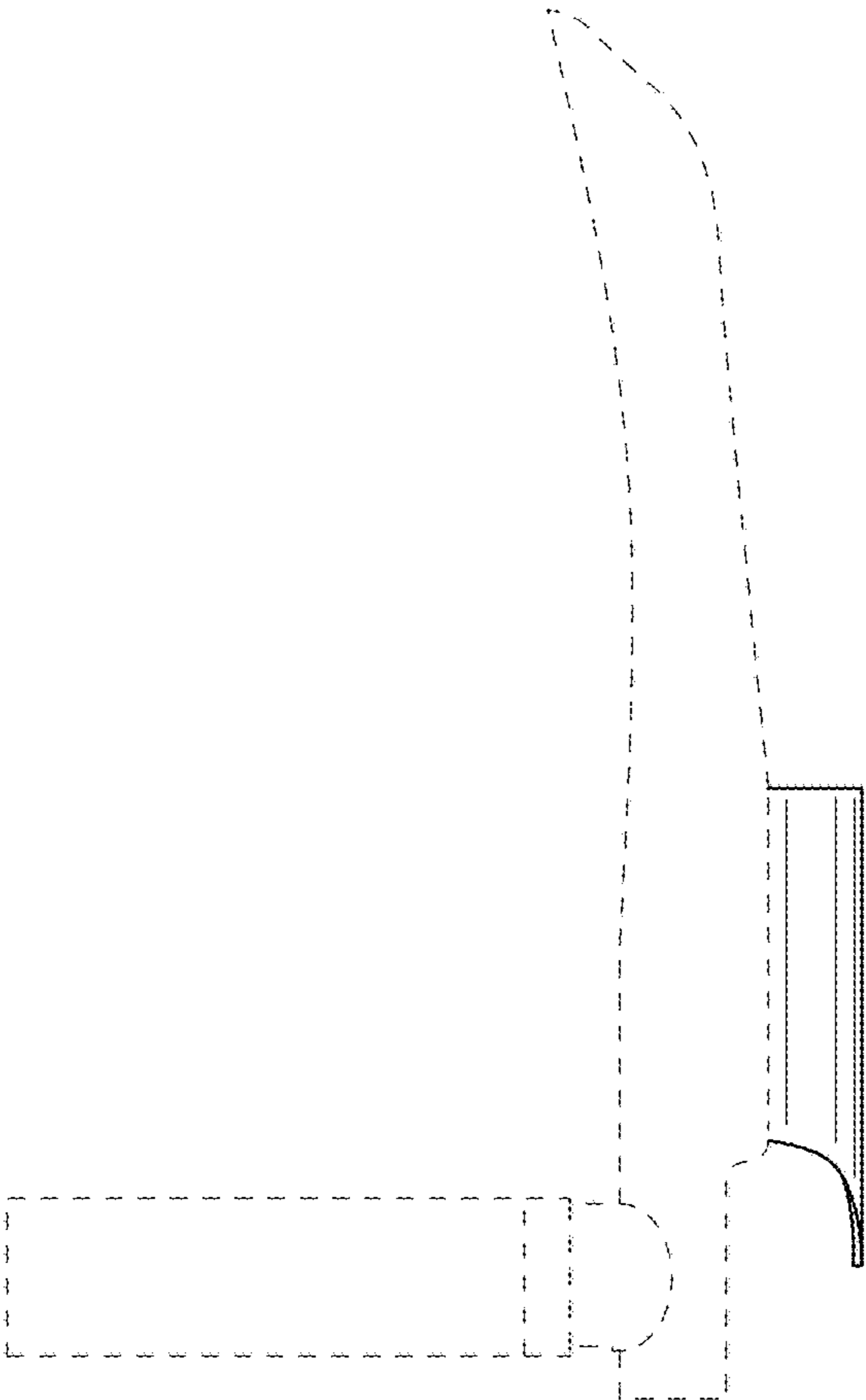

FIG.3

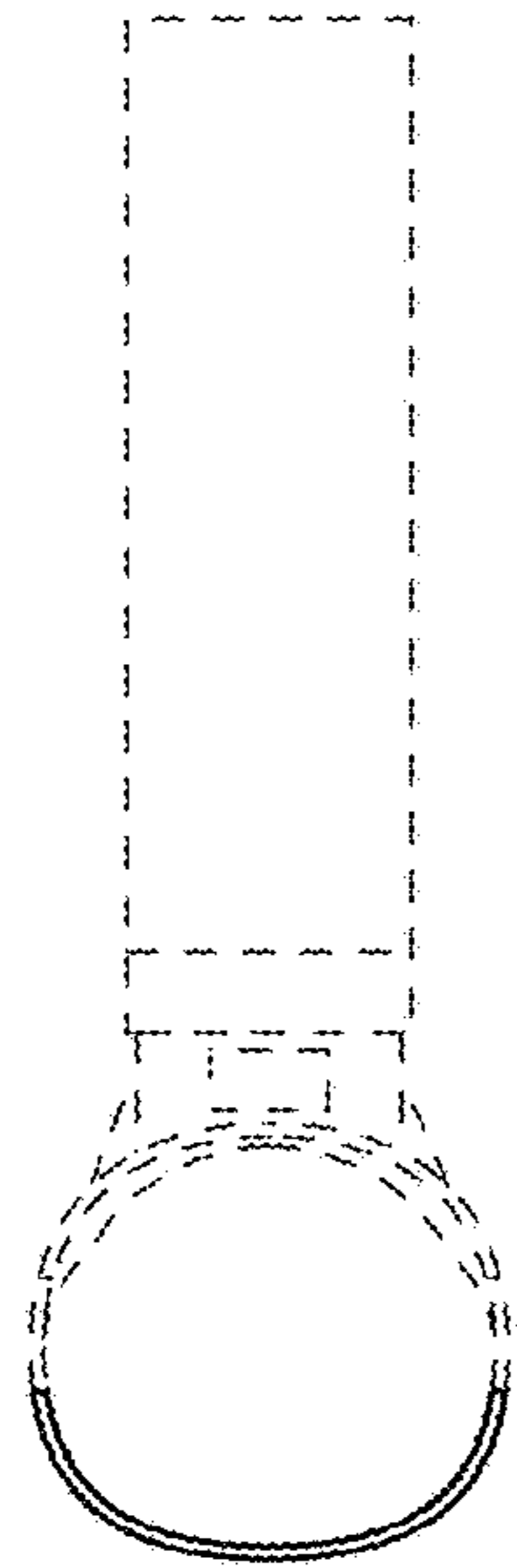

FIG. 4

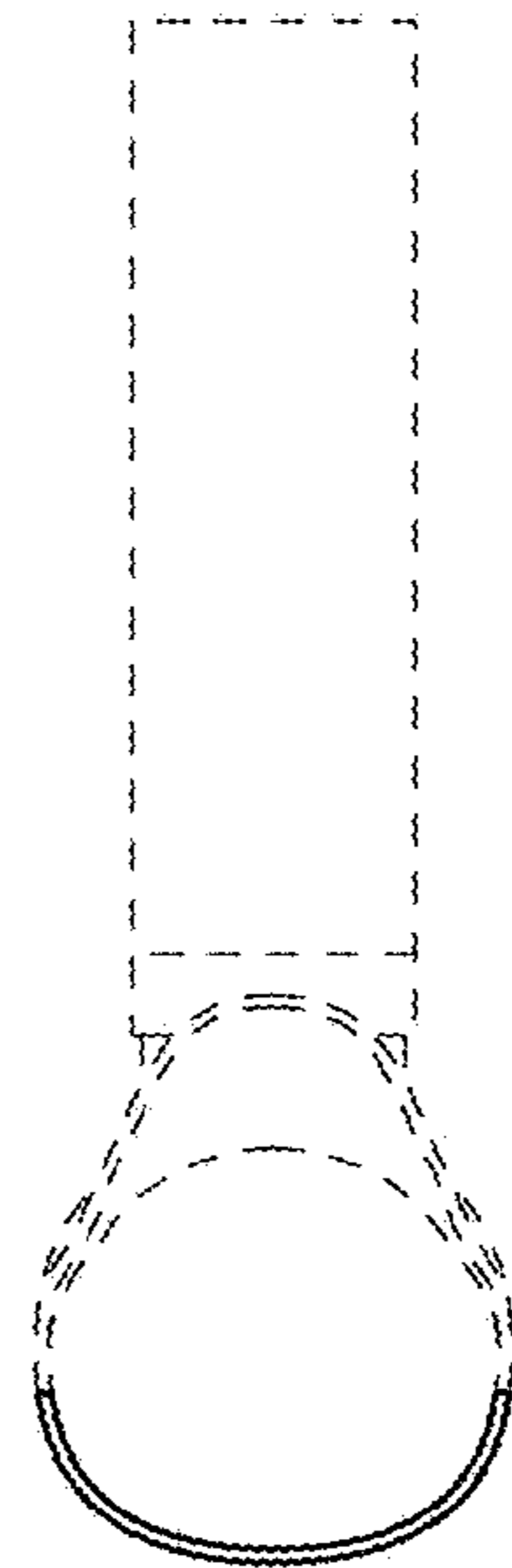

FIG. 5

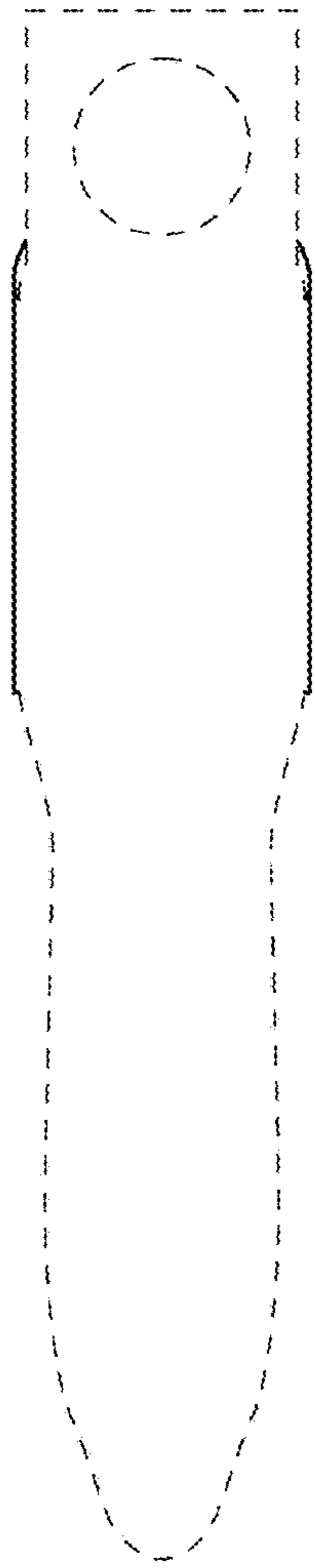

FIG. 6

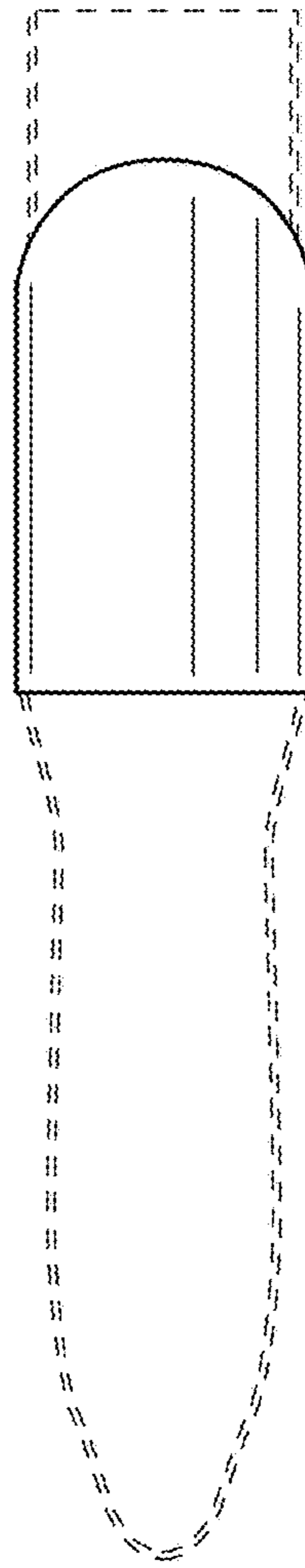

FIG. 7