



US00D866744S

(12) **United States Design Patent**
Gobber et al.

(10) **Patent No.:** **US D866,744 S**

(45) **Date of Patent:** **** Nov. 12, 2019**

(54) **AIR FRESHENER**

(71) Applicant: **ZOBELE HOLDING SPA**, Trento (IT)

(72) Inventors: **Cedric Gobber**, Barcelona (ES);
Joaquim Llorente Alonso, Barcelona
(ES); **Åsa Jonsson**, Barcelona (ES)

(73) Assignee: **ZOBELE HOLDING S.P.A.**, Trento
(IT)

(**) Term: **15 Years**

(21) Appl. No.: **35/504,006**

(22) Filed: **May 24, 2017**

(80) **Hague Agreement Data**

Int. Filing Date: **May 24, 2017**

Int. Reg. No.: **DM/096282**

Int. Reg. Date: **May 24, 2017**

Int. Reg. Pub. Date: **Nov. 24, 2017**

(30) **Foreign Application Priority Data**

Nov. 24, 2016 (ES) D524481

(51) **LOC (12) Cl.** **23-99**

(52) **U.S. Cl.**
USPC **D23/366**

(58) **Field of Classification Search**

USPC D23/207, 208, 360, 364-369, 388;
D22/119, 122

CPC A61L 9/00; A61L 9/02; A61L 9/03; A61L
9/034; A61L 9/04; A61L 9/12; A61L
9/032; A61L 9/122; A61L 9/127; A61L
9/22; B01D 46/00; B01D 46/0002; B01D
46/20; F02M 35/04; F24F 13/20; A62B
21/00

See application file for complete search history.

(56) **References Cited**

U.S. PATENT DOCUMENTS

D550,824 S *	9/2007	Zobeles	D23/359
D585,536 S *	1/2009	Wang	D23/364
D609,321 S *	2/2010	Tomasulo	D23/366
D673,241 S *	12/2012	Choi	D23/207
D683,439 S *	5/2013	Choi	D23/364
D707,339 S *	6/2014	Garbusi	D23/366
D754,831 S *	4/2016	Yin	D23/359
D801,505 S *	10/2017	Yin	D23/364

* cited by examiner

Primary Examiner — Keli L Hill

(74) *Attorney, Agent, or Firm* — Ostrolenk Faber LLP

(57) **CLAIM**

The ornamental design for an air freshener, as shown and described.

DESCRIPTION

1. Air freshener

FIG. 1.1 is a left side elevation view of an air freshener according to the new design.

FIG. 1.2 is a rear elevation view.

FIG. 1.3 is a right side elevation view.

FIG. 1.4 is a front elevation view.

FIG. 1.5 is a top, front and right side perspective view.

FIG. 1.6 is a top plan view.

FIG. 1.7 is a bottom plan view.

The broken lines shown in the Drawings represent unclaimed portions of the air freshener and form no part of the claimed design.

1 Claim, 7 Drawing Sheets

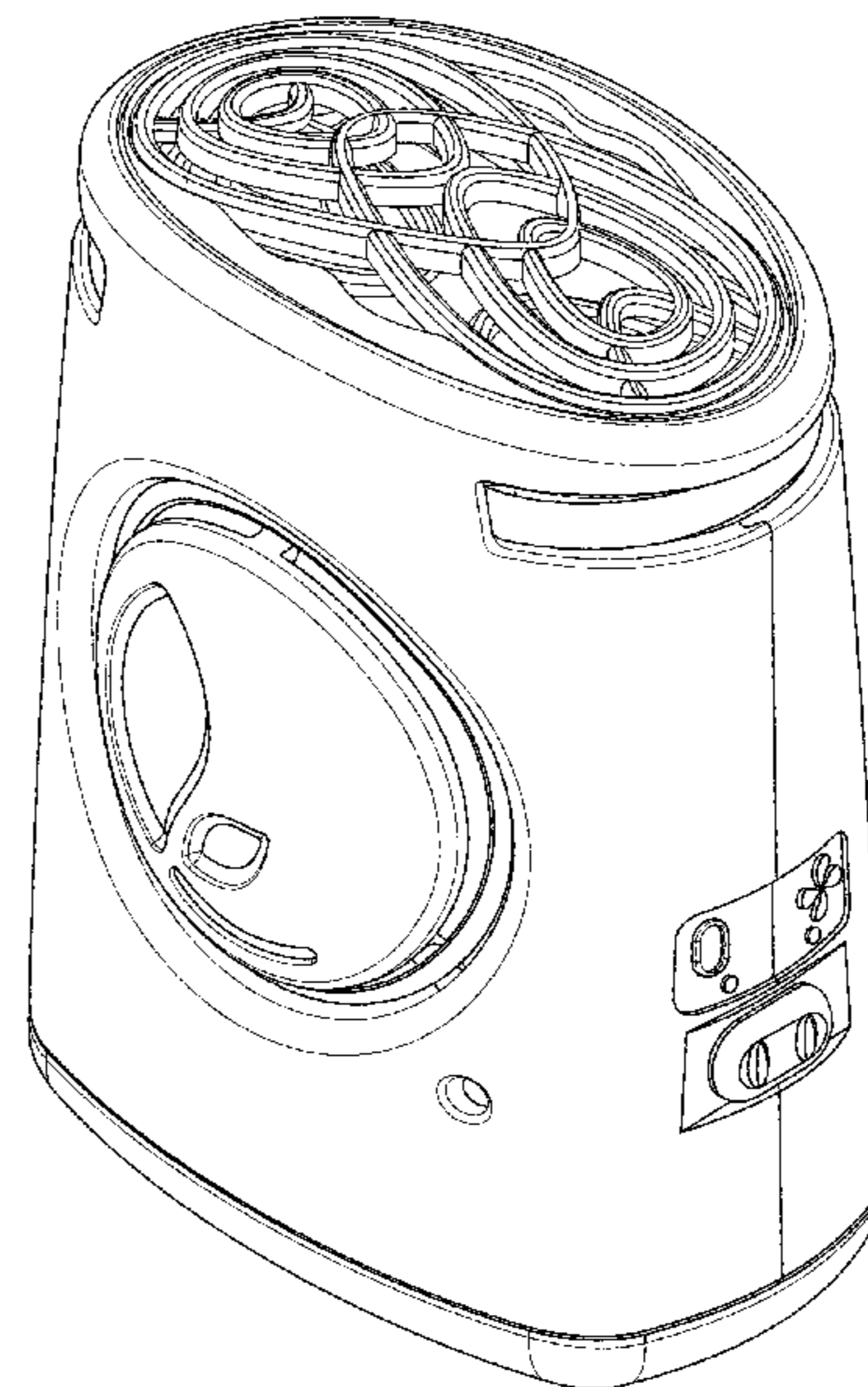
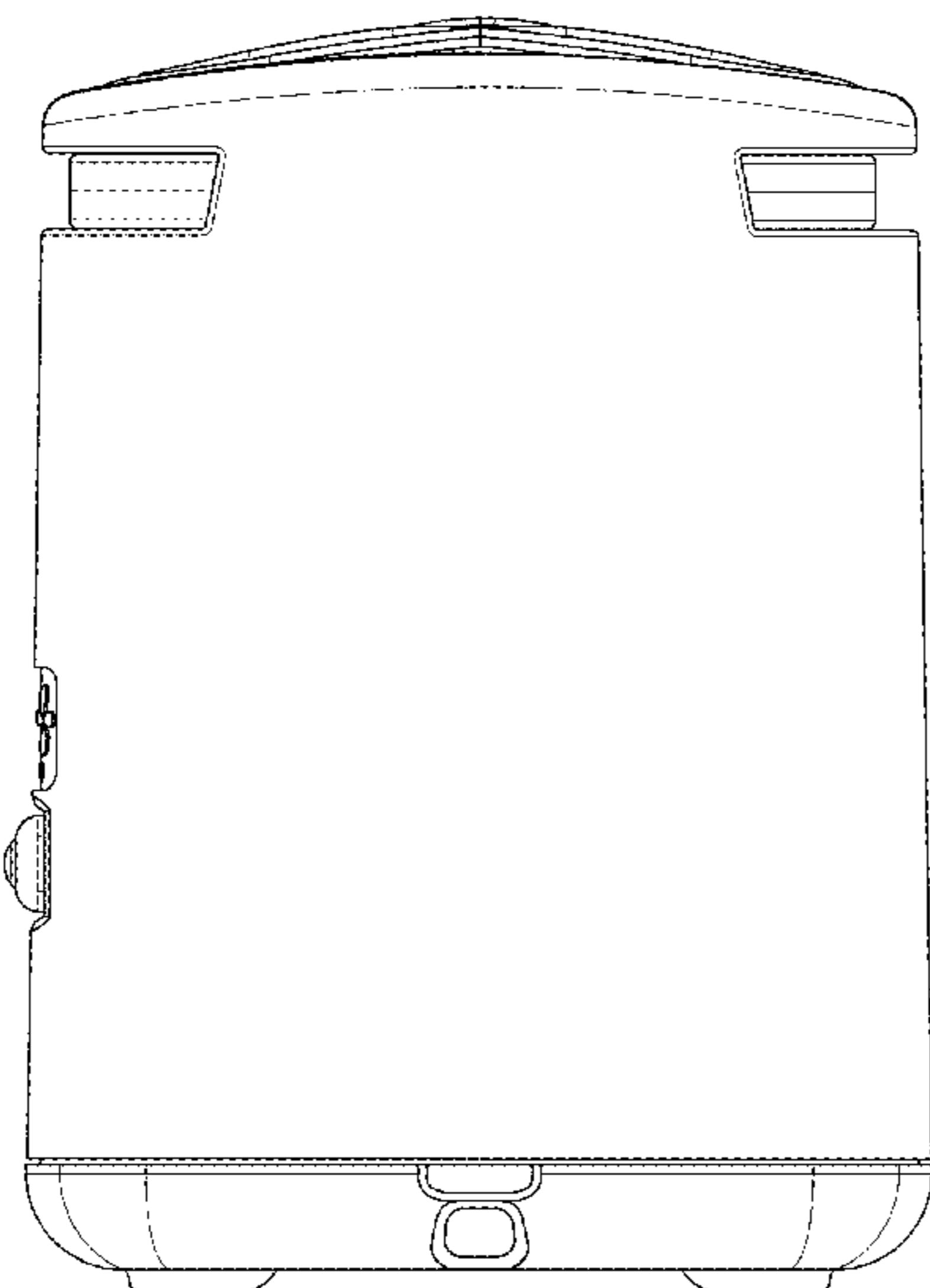

1.1

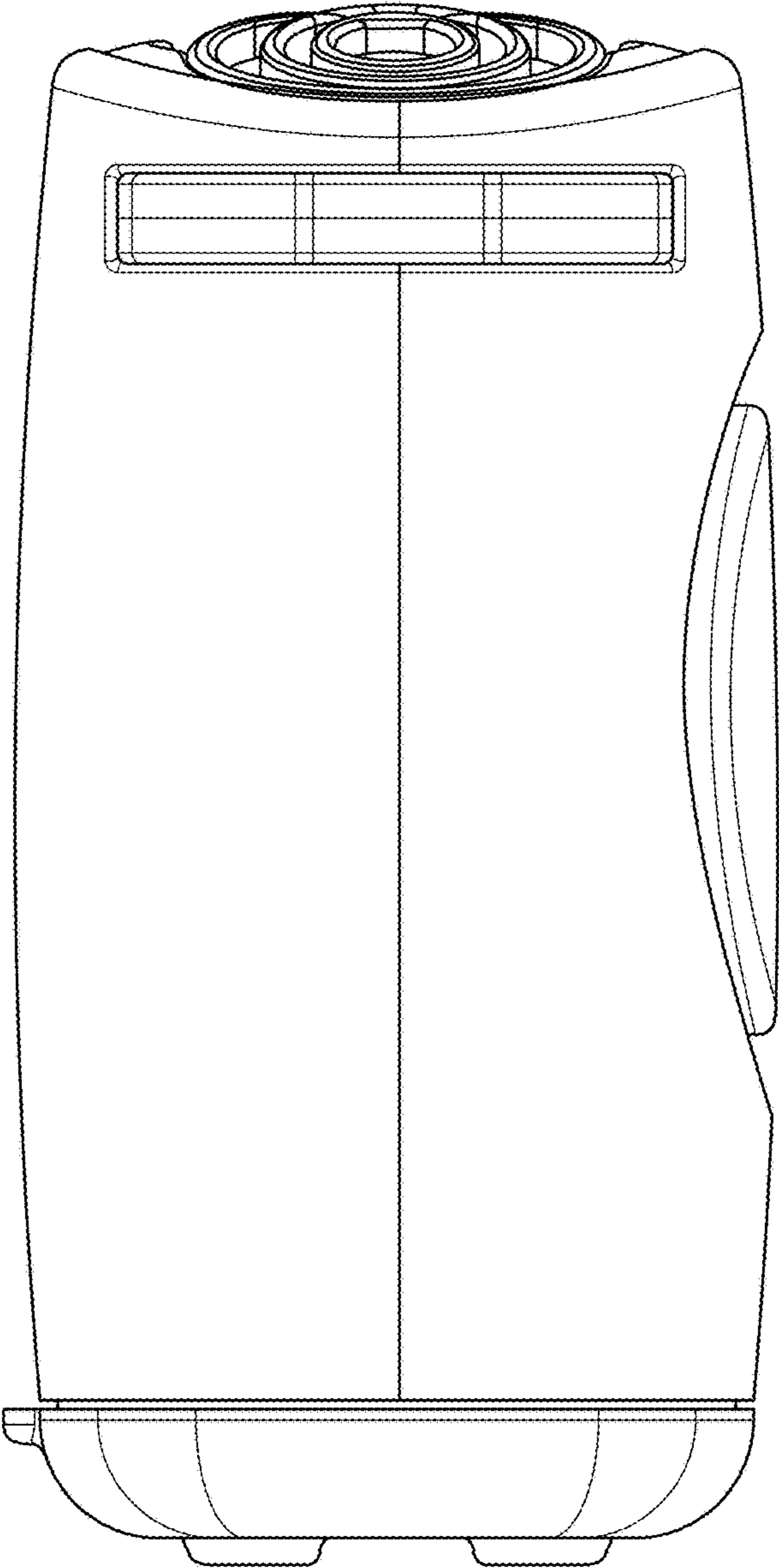

1.2

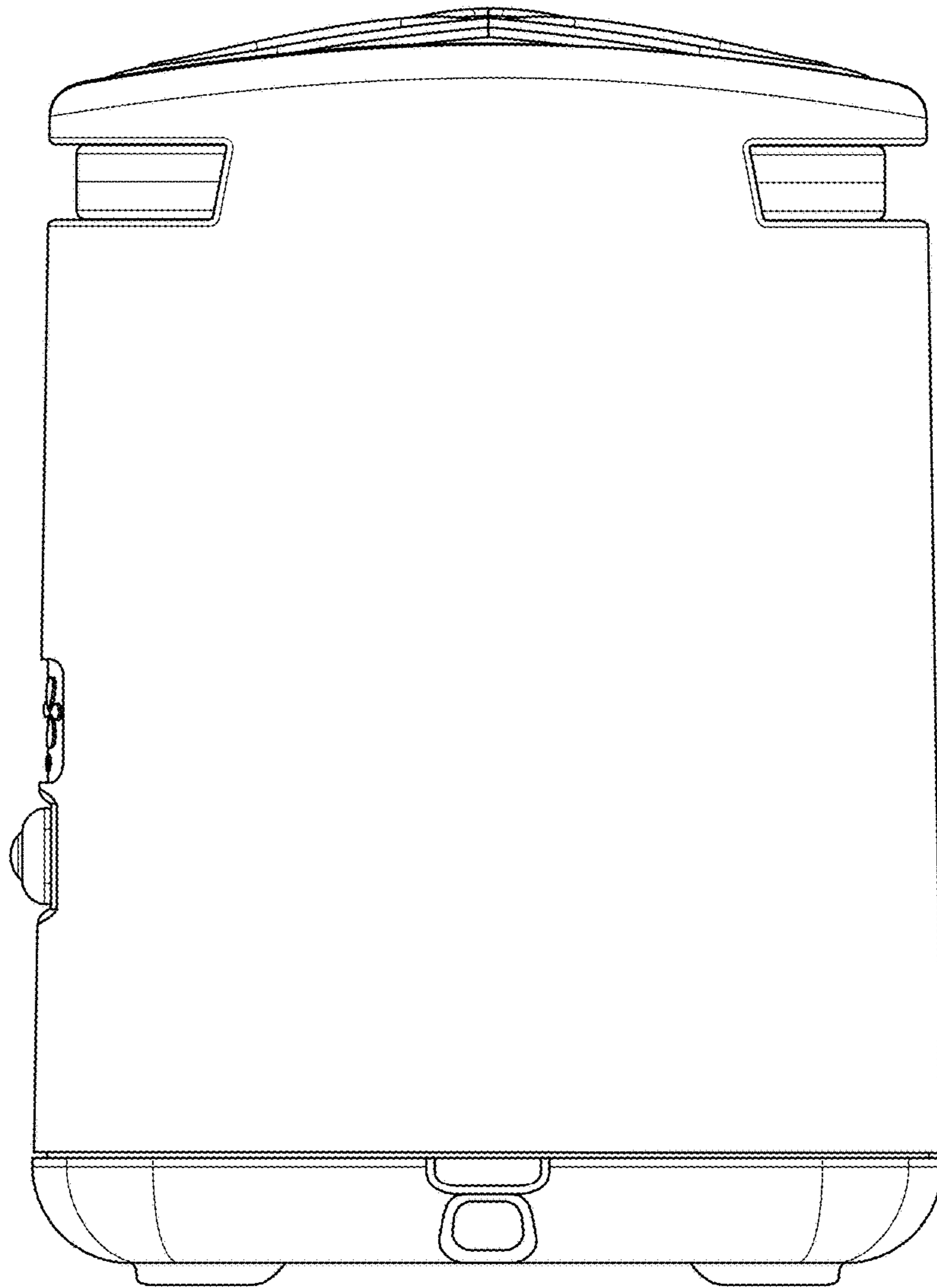

1.3

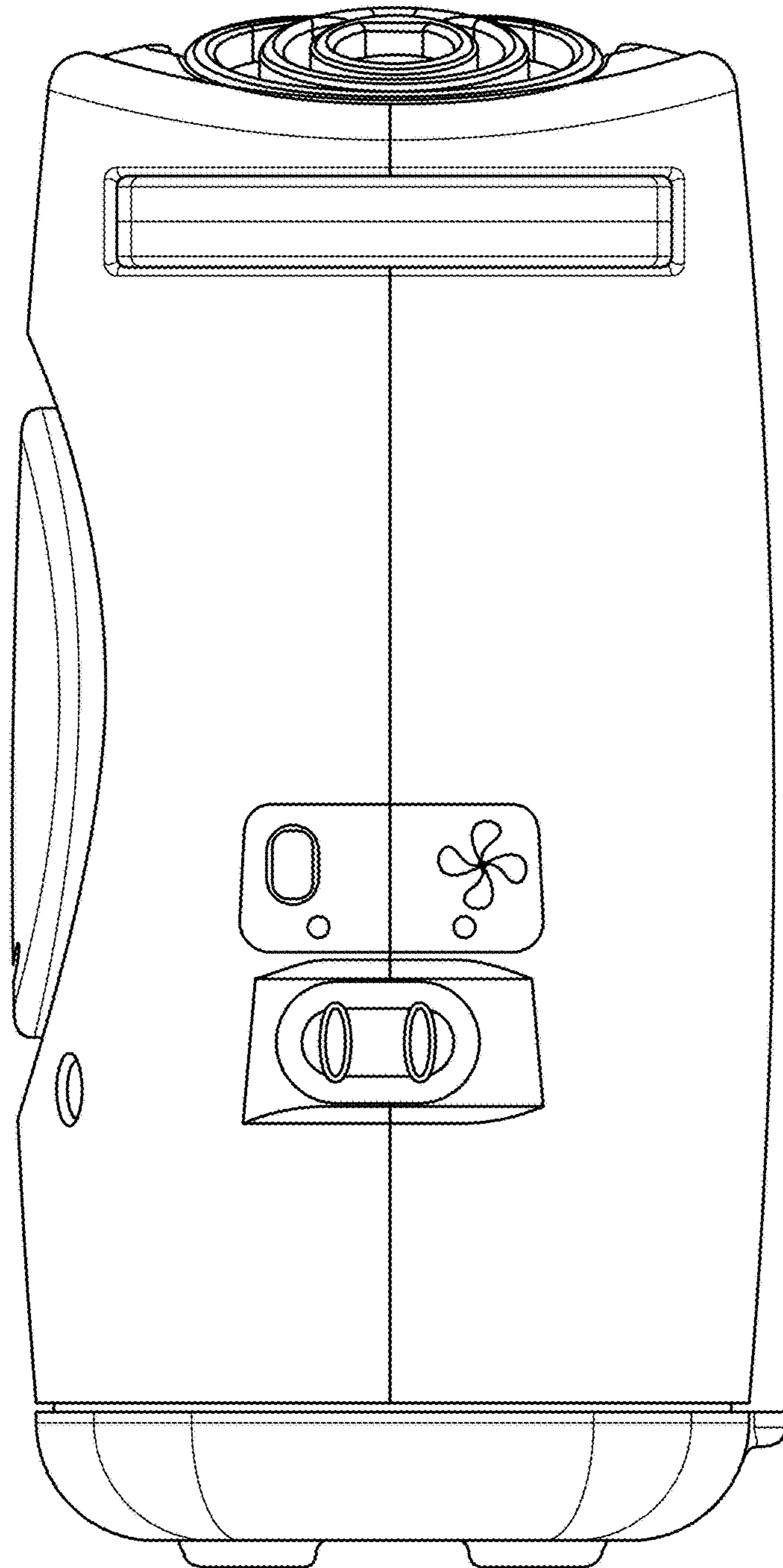

1.4

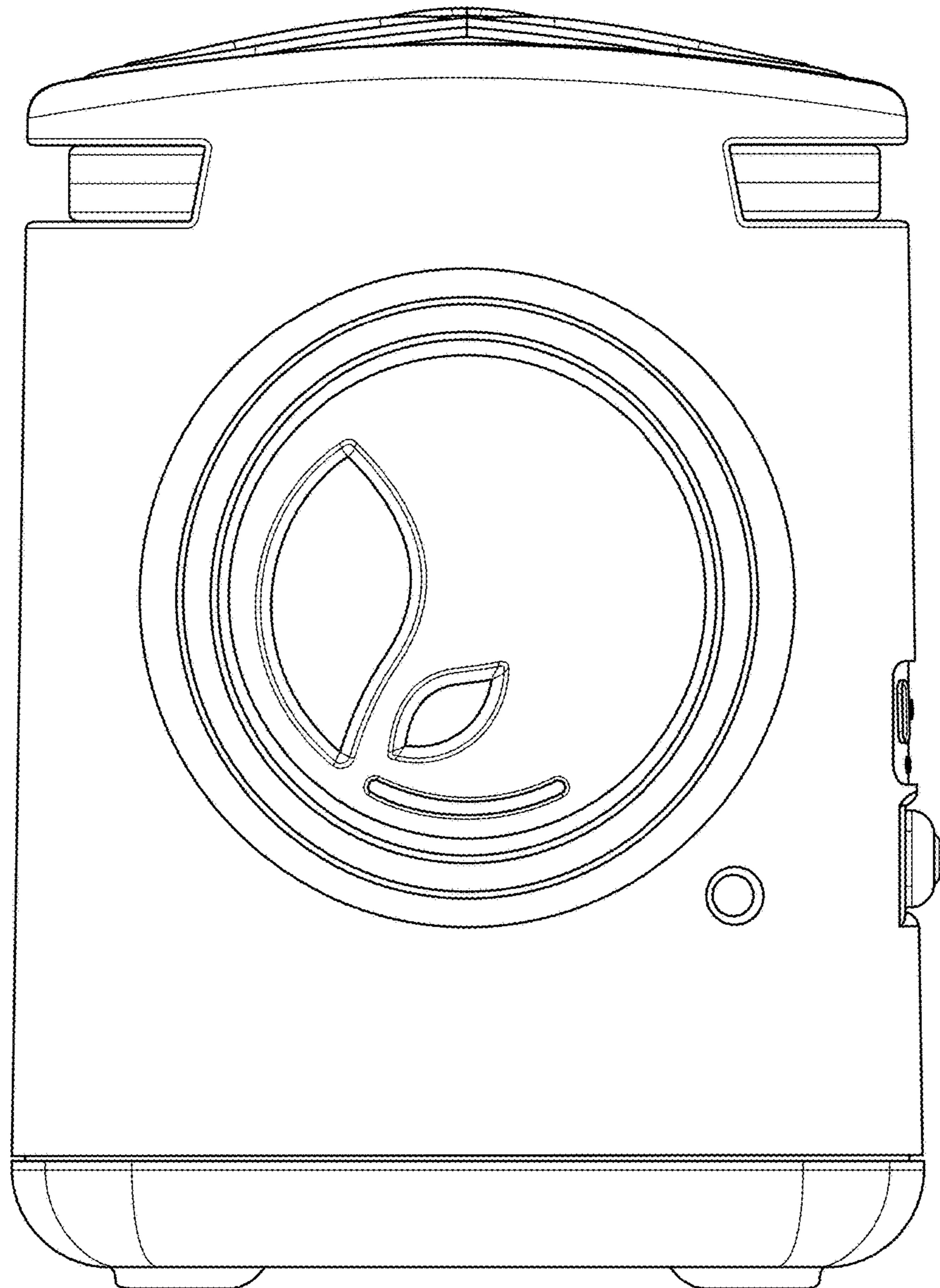

1.5

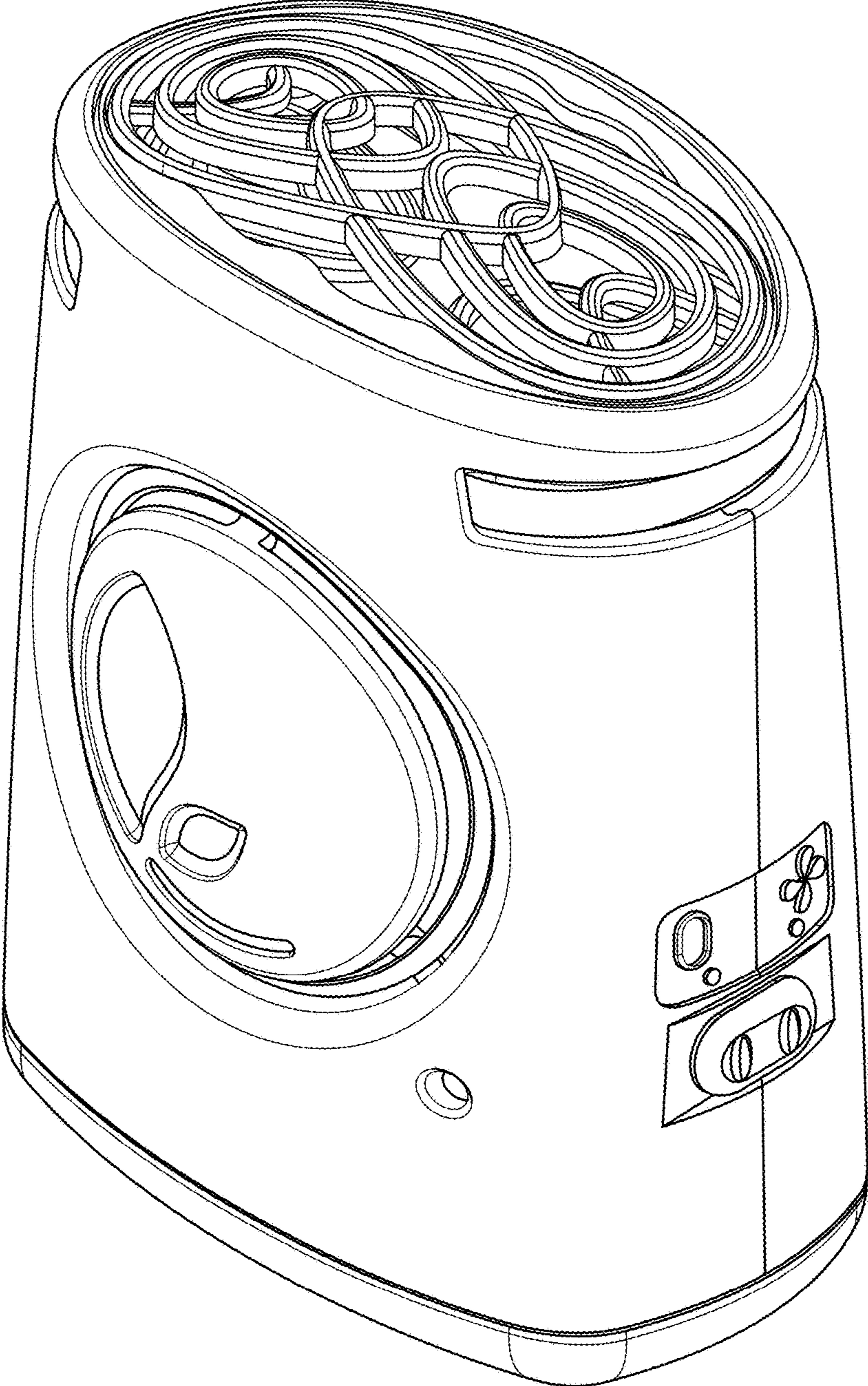

1.6

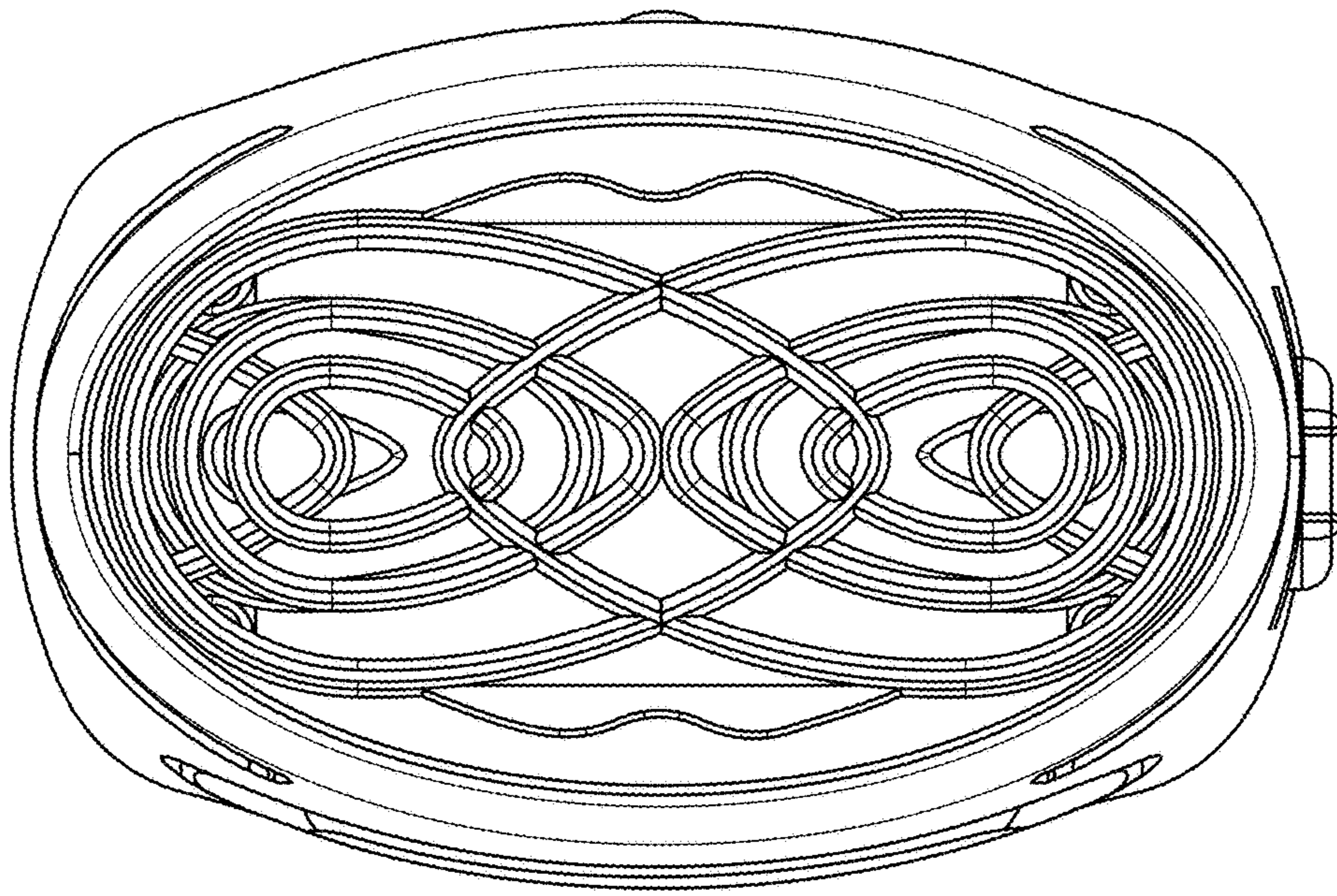

1.7

