



US00D866743S

(12) **United States Design Patent**  
**Lee**

(10) **Patent No.:** **US D866,743 S**

(45) **Date of Patent:** **\*\* Nov. 12, 2019**

(54) **AROMA DIFFUSER**

(71) Applicant: **Bloomy Lotus Ltd**, Hong Kong (HK)

(72) Inventor: **Leander Lee**, Hong Kong (HK)

(73) Assignee: **Bloomy Lotus Ltd**, Hong Kong (HK)

(\*\*) Term: **15 Years**

(21) Appl. No.: **29/656,511**

(22) Filed: **Jul. 13, 2018**

(30) **Foreign Application Priority Data**

Jun. 1, 2018 (HK) ..... 1801079.7M001

(51) **LOC (12) Cl.** ..... **23-04**

(52) **U.S. Cl.**  
USPC ..... **D23/366**

(58) **Field of Classification Search**  
USPC ..... D23/208, 355-369, 393; D14/209.1,  
D14/212-213; D8/1, 391  
CPC ..... A61L 9/02; A61L 9/03; A61L 9/12; A61L  
9/035; A61L 9/125; A61L 2209/15; A61L  
2209/16  
See application file for complete search history.

(56) **References Cited**

**U.S. PATENT DOCUMENTS**

D277,453 S \* 2/1985 Wilman ..... D8/323  
D433,918 S \* 11/2000 Bradley ..... D8/323

D532,094 S \* 11/2006 Hundertmark ..... D23/366  
D535,379 S \* 1/2007 Hundertmark ..... D23/366  
D567,918 S \* 4/2008 Hundertmark ..... D23/366  
D767,109 S \* 9/2016 Gobber ..... D23/368  
D806,222 S \* 12/2017 Gobber ..... D23/366

\* cited by examiner

*Primary Examiner* — Sheryl Lane

*Assistant Examiner* — Calvin E Vansant

(57) **CLAIM**

The ornamental design for an aroma diffuser, as shown and described.

**DESCRIPTION**

FIG. 1 is a front elevational view of an aroma diffuser showing my new design;  
FIG. 2 is a rear elevational view thereof;  
FIG. 3 is a left side view thereof;  
FIG. 4 is a right side view thereof;  
FIG. 5 is a top plan view thereof;  
FIG. 6 is a bottom plan view thereof;  
FIG. 7 is a top, rear and left side perspective view thereof;  
and,  
FIG. 8 is a bottom, rear and right side perspective view thereof.

**1 Claim, 8 Drawing Sheets**

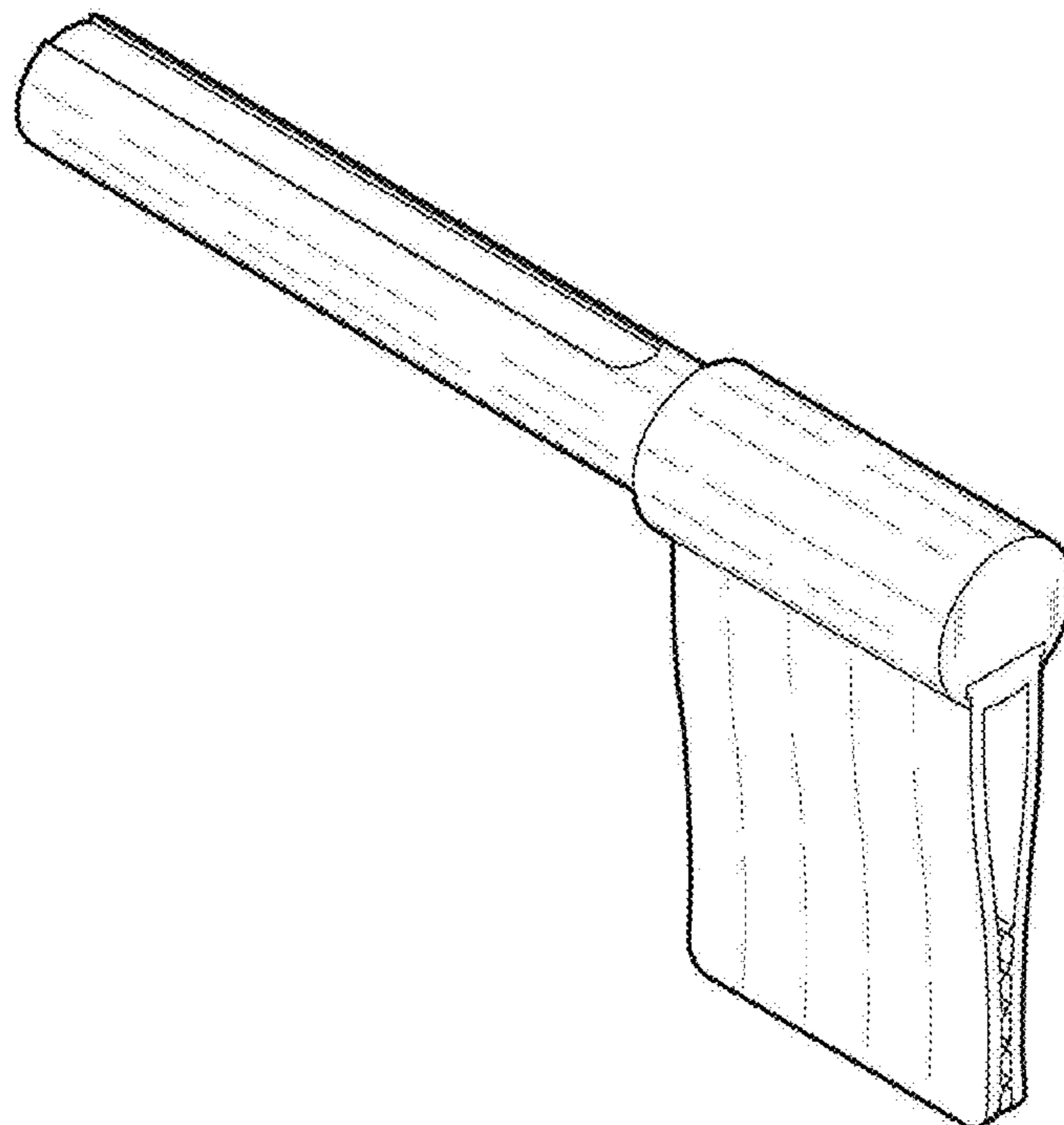

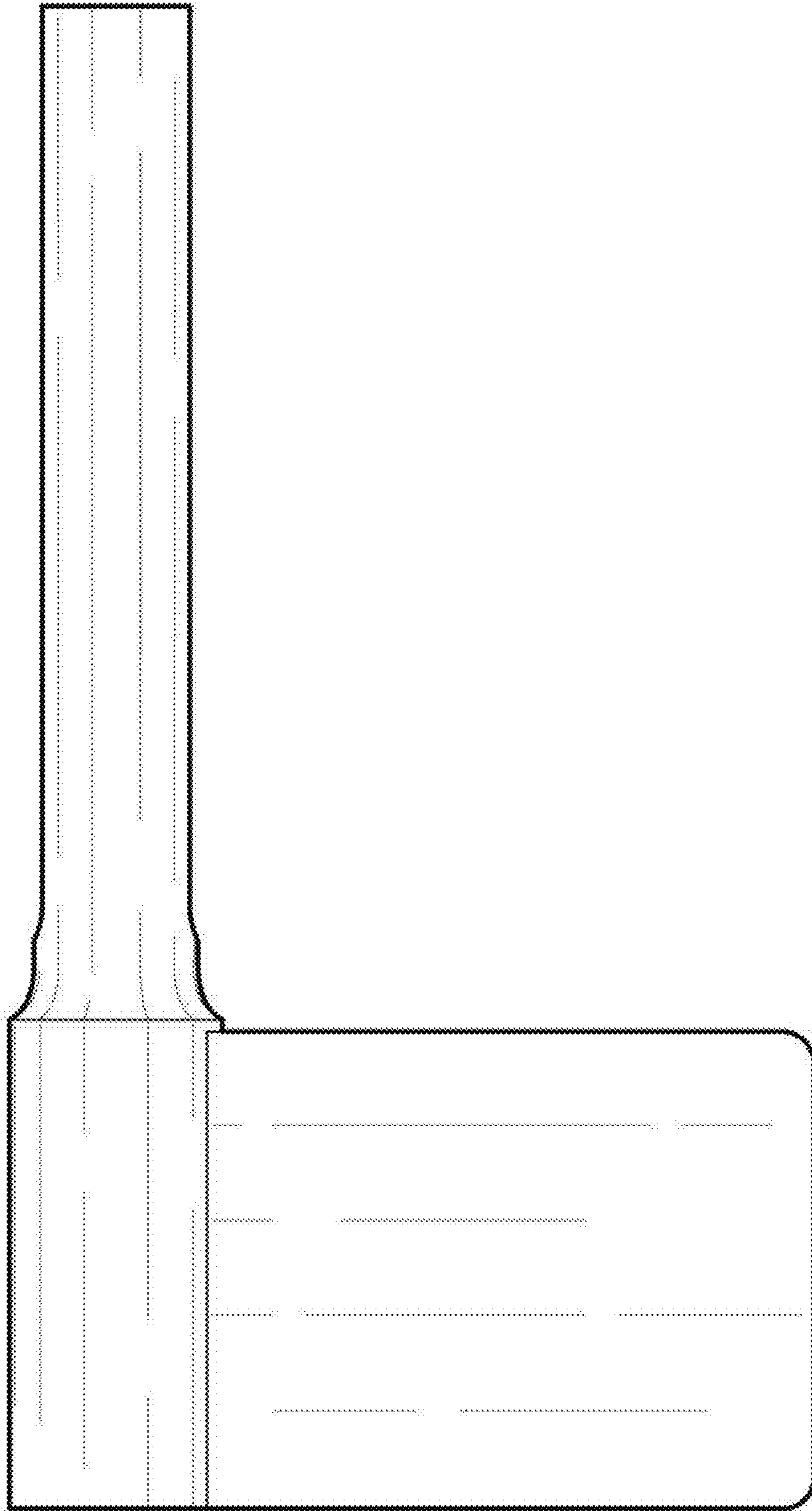

Fig. 1

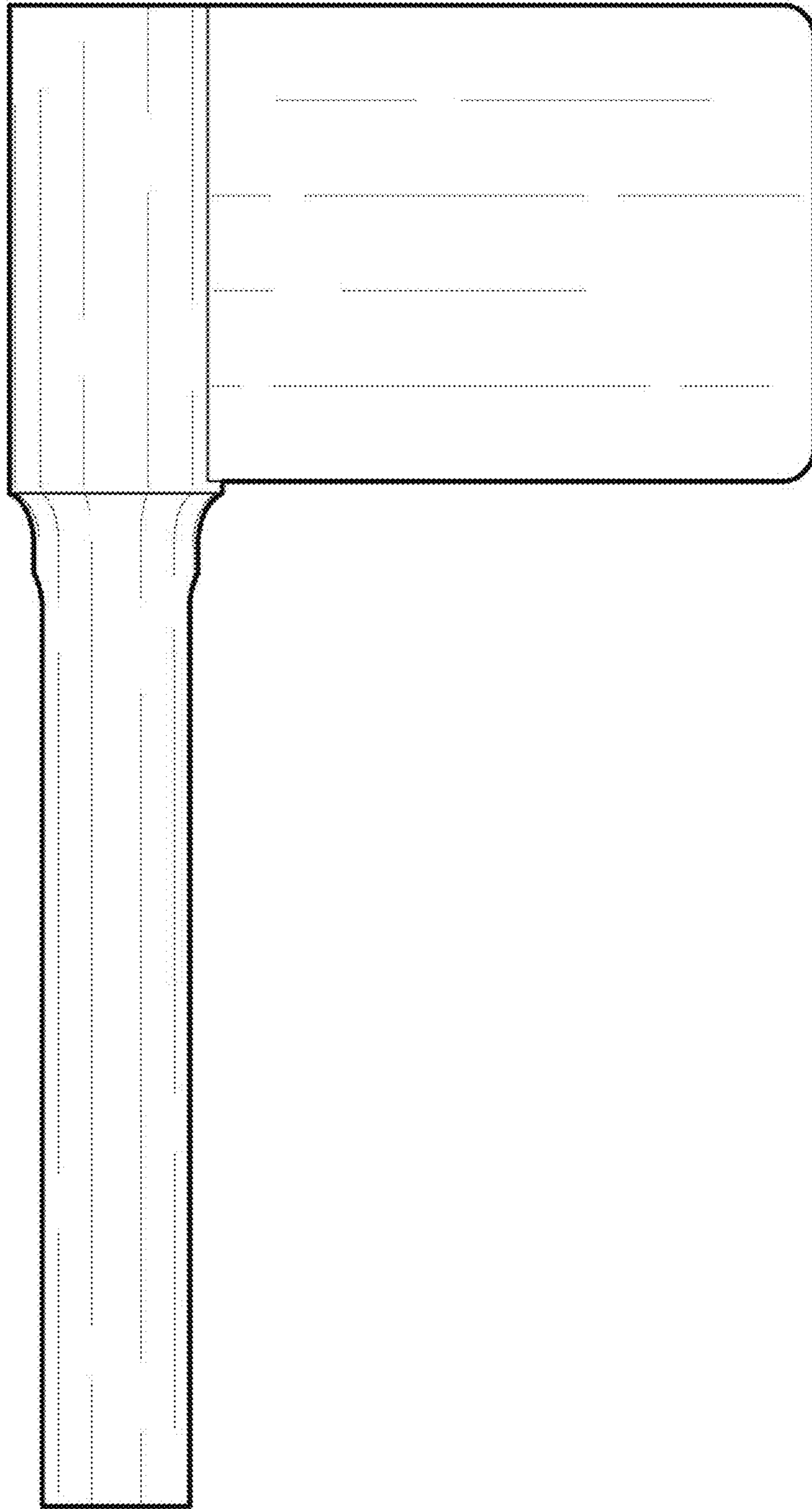

Fig. 2

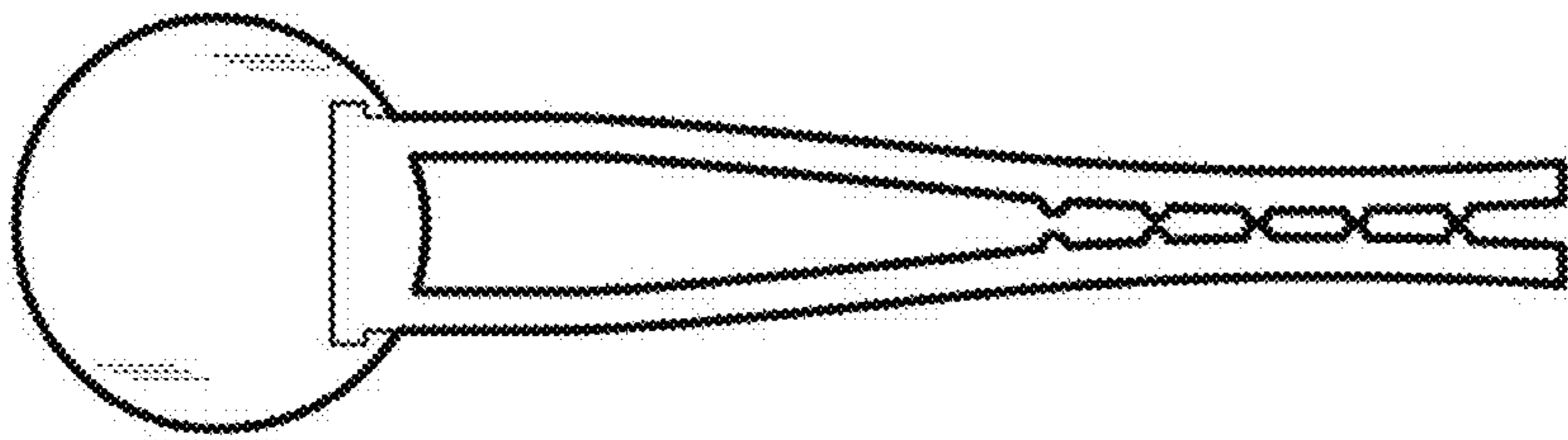

Fig. 3

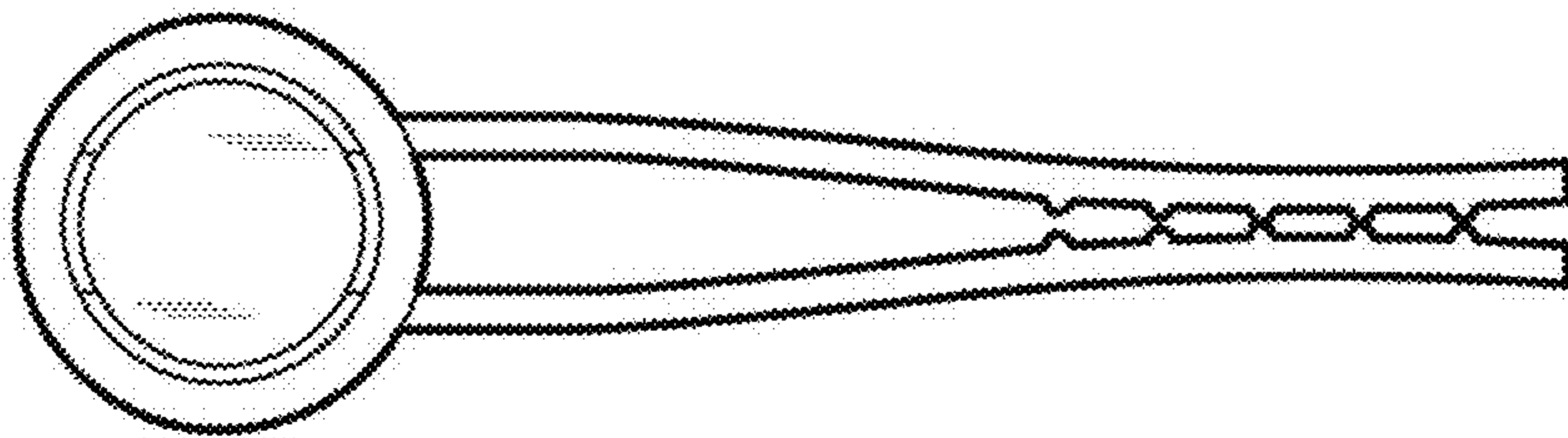

Fig. 4

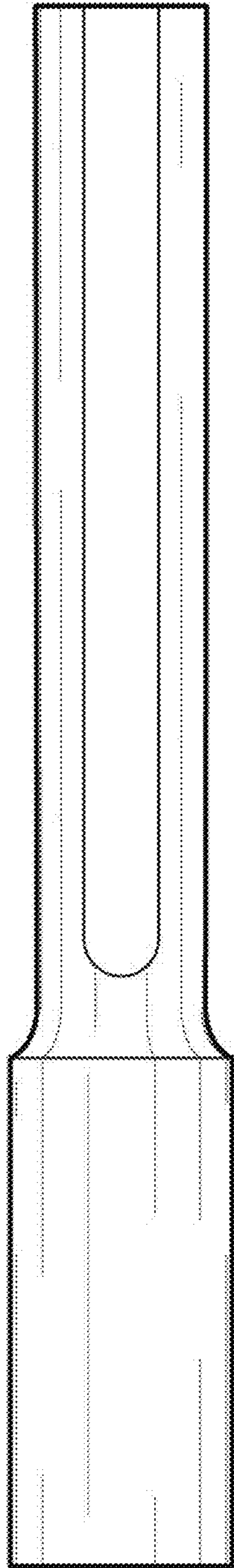

Fig. 5



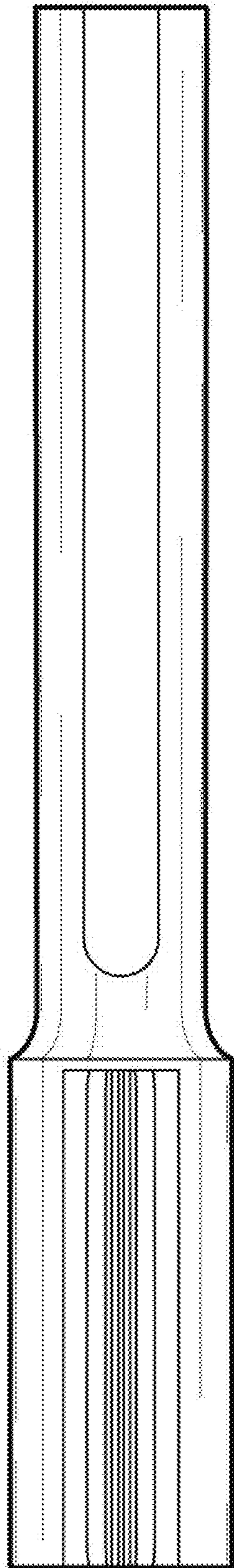

Fig. 6

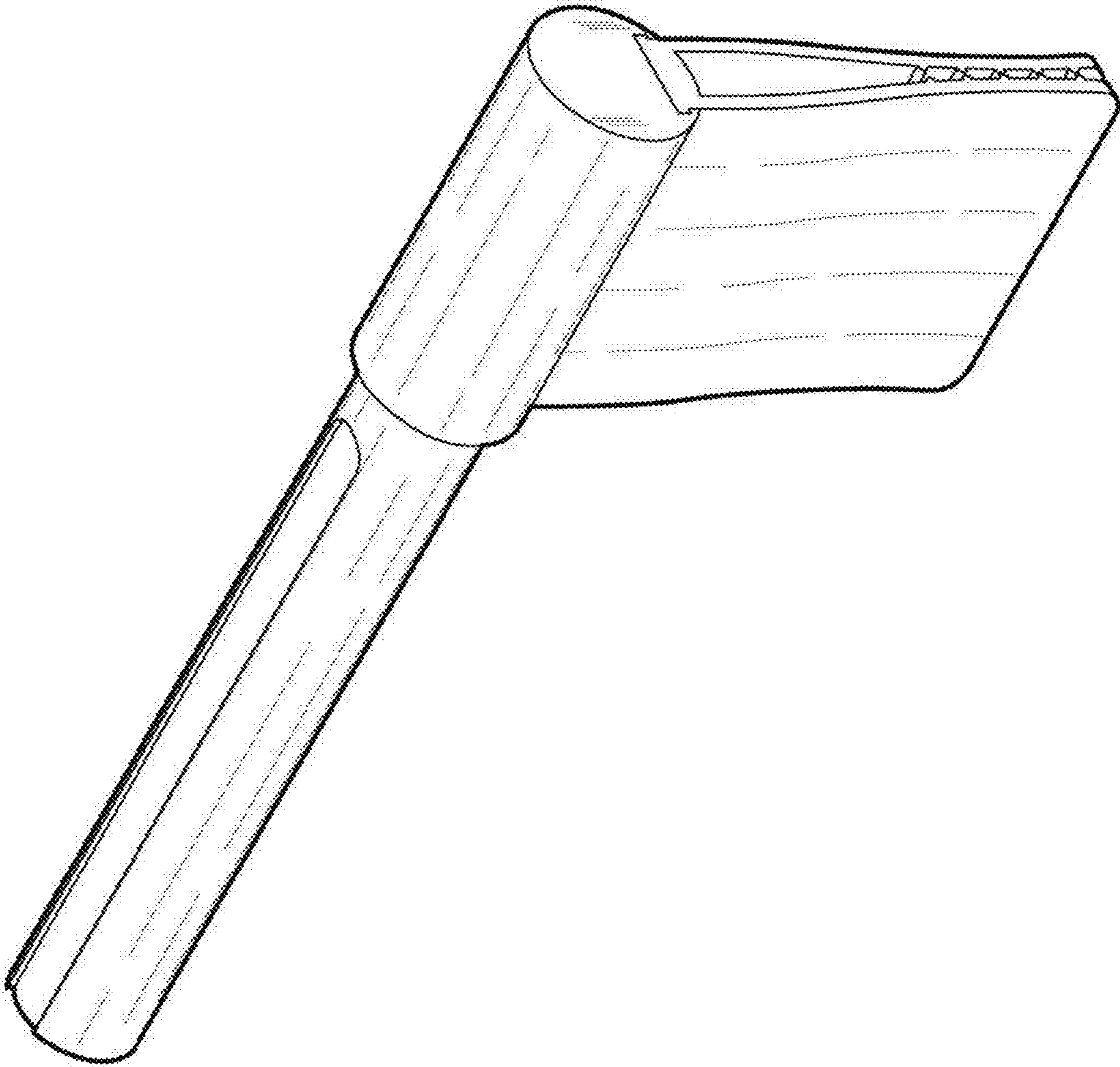

Fig. 7



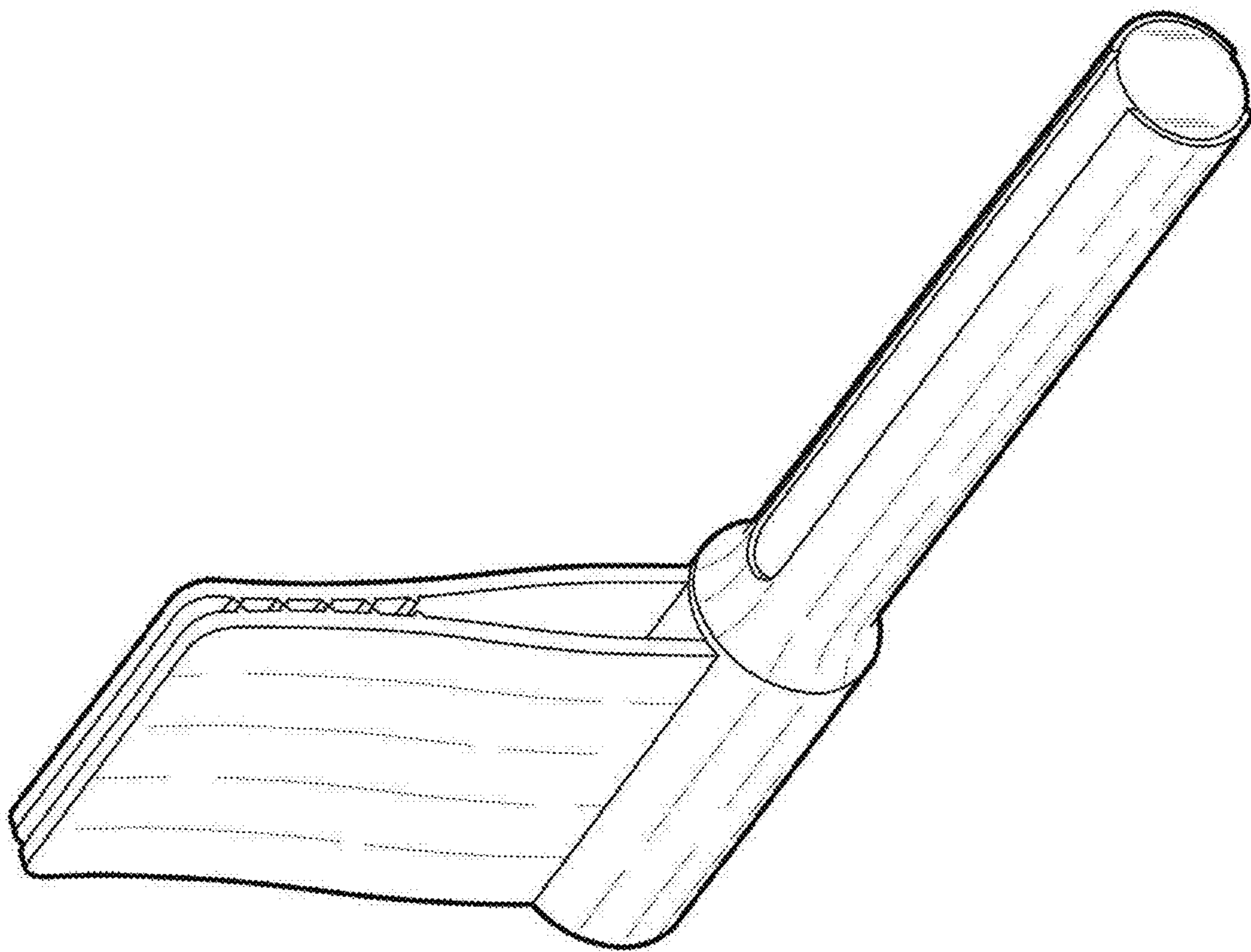

Fig. 8