



US00D866733S

(12) **United States Design Patent** (10) **Patent No.:** **US D866,733 S**
Henize et al. (45) **Date of Patent:** **** Nov. 12, 2019**

- (54) **TOILET SEAT**
- (71) Applicant: **Lawrence Henize**, Jacksonville, FL
(US)
- (72) Inventors: **Lawrence Henize**, Jacksonville, FL
(US); **Steve Simonelli**, Franklin, NC
(US)
- (73) Assignee: **Lawrence Henize**, Jacksonville, FL
(US)
- (**) Term: **15 Years**
- (21) Appl. No.: **29/699,229**
- (22) Filed: **Jul. 24, 2019**
- (51) **LOC (12) Cl.** **23-02**
- (52) **U.S. Cl.**
USPC **D23/311**
- (58) **Field of Classification Search**
USPC D23/303, 309-312, 295-296
CPC A47K 13/00; A47K 13/06
See application file for complete search history.

- D237,185 S * 10/1975 O'Neil D23/311
- D306,641 S * 3/1990 Kohler, Jr. D23/311
- D472,622 S * 4/2003 Klippenstein D23/311
- D733,272 S * 6/2015 Kato D23/311

* cited by examiner

Primary Examiner — Robert A Delehanty
(74) *Attorney, Agent, or Firm* — Ashkan Najafi

(57) **CLAIM**

The ornamental design for a toilet seat, as shown and described.

DESCRIPTION

FIG. 1 is a perspective view of a toilet seat showing my new design;
FIG. 2 is a top plan view thereof;
FIG. 3 is a bottom plan view thereof;
FIG. 4 is a front elevational view thereof;
FIG. 5 is a rear elevational view thereof;
FIG. 6 is a right side elevational view thereof; and,
FIG. 7 is a left side elevational view thereof.
The broken lines shown in the drawing figures illustrate elements of the article of manufacture that form no part of Applicant's claimed invention.

- (56) **References Cited**
U.S. PATENT DOCUMENTS
1,678,501 A * 7/1928 Feldman A47K 13/06
4/239
D142,755 S * 10/1945 Williams, Jr. D23/311

1 Claim, 4 Drawing Sheets

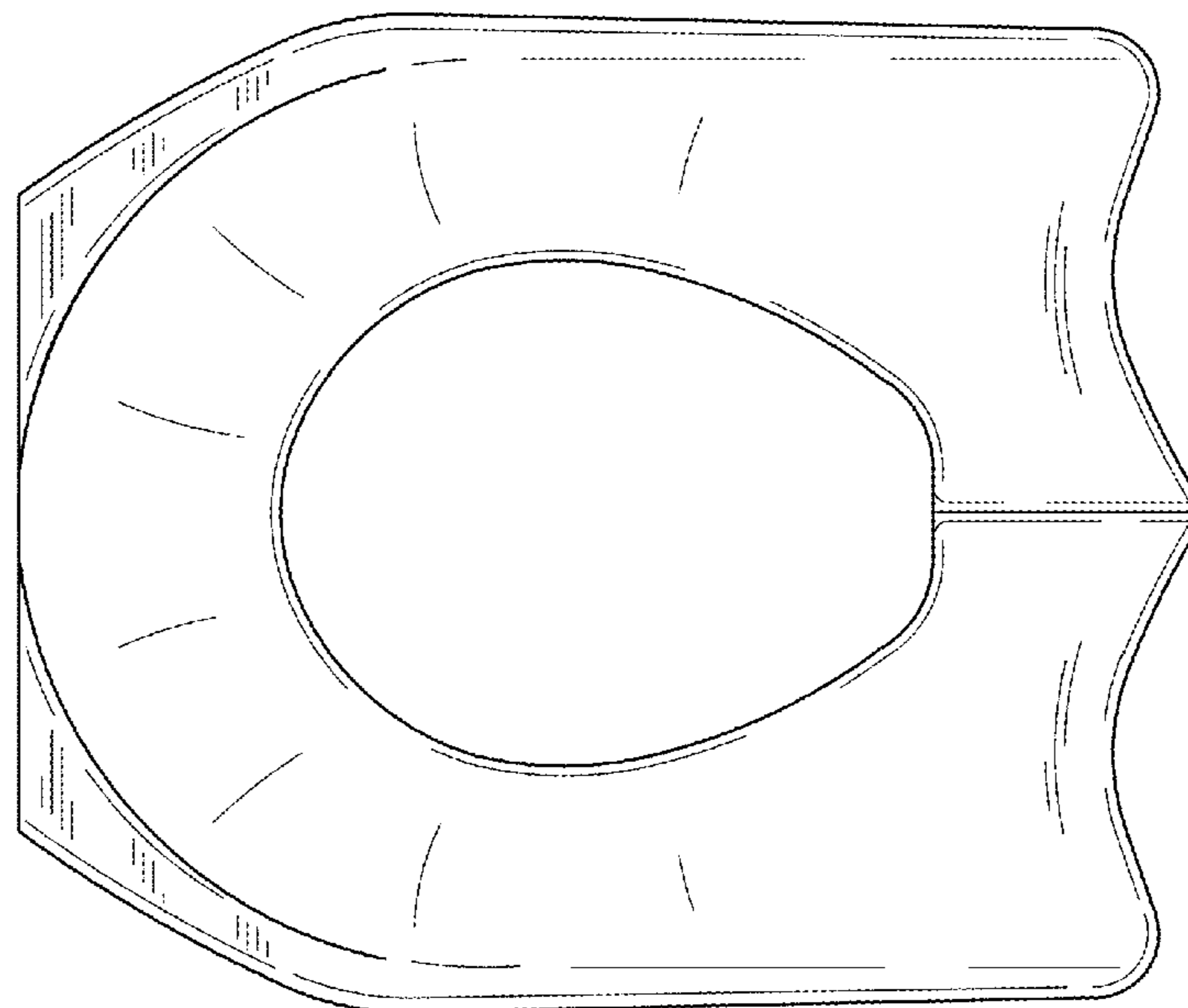

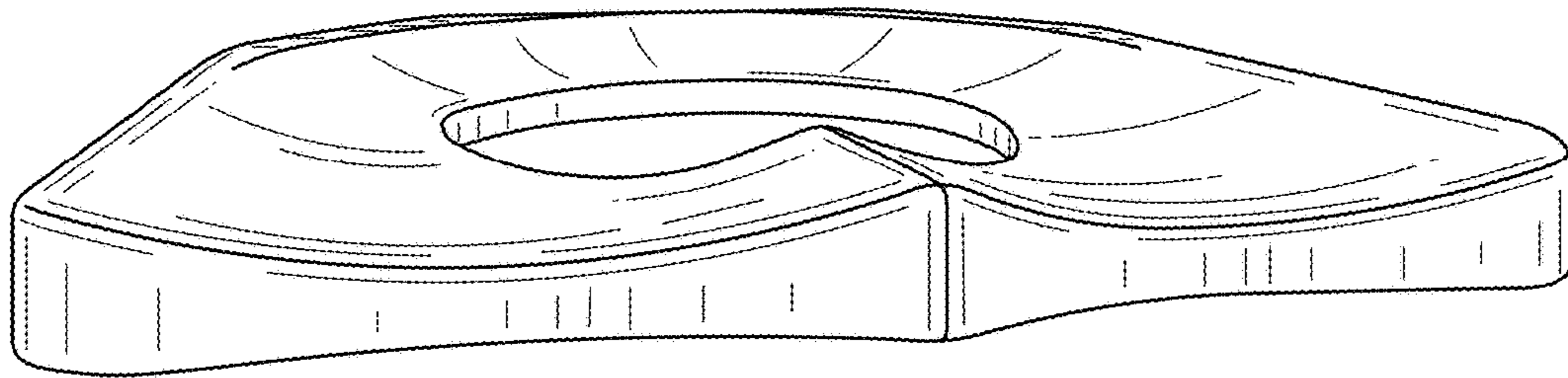

FIG. 1

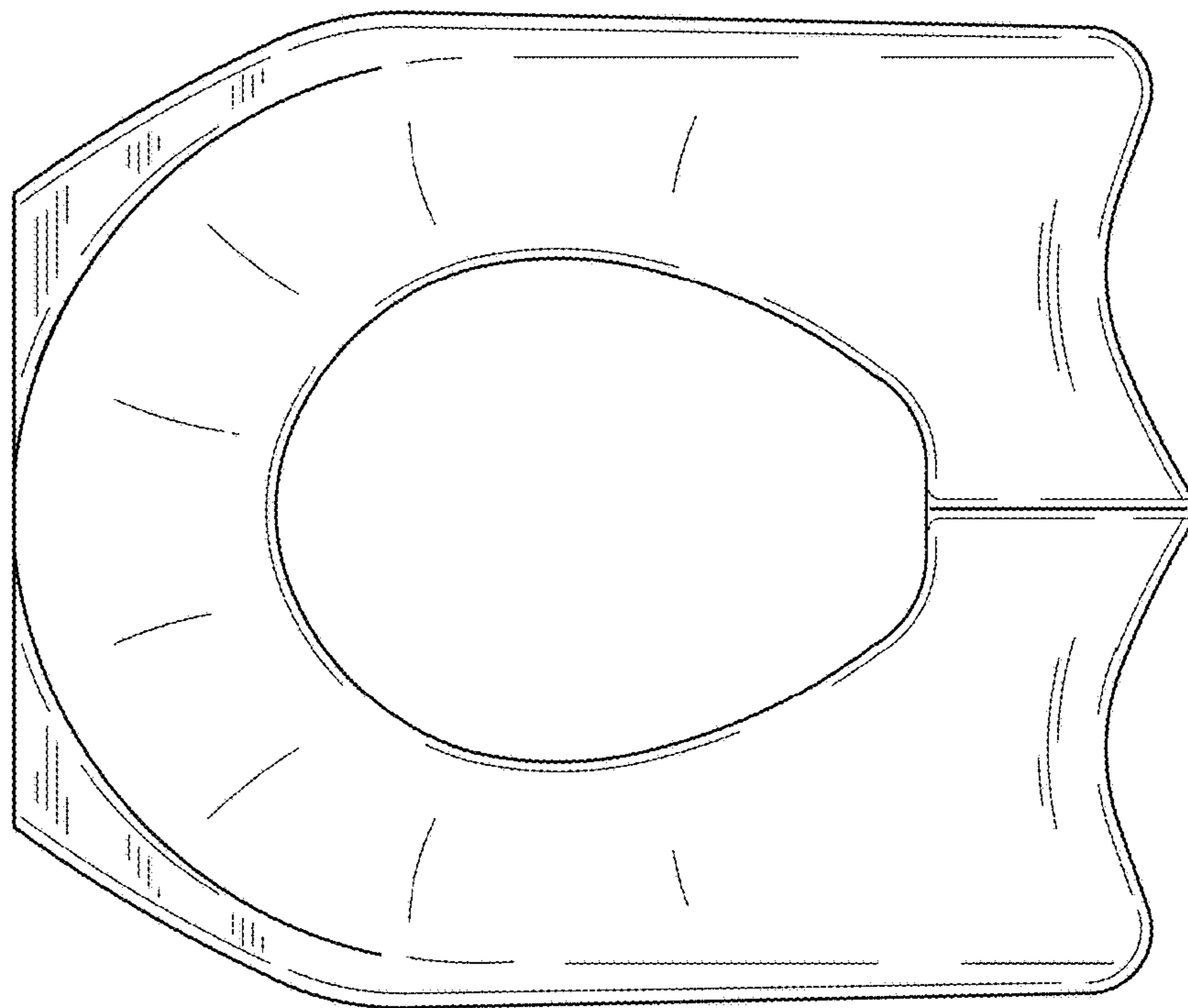

FIG. 2

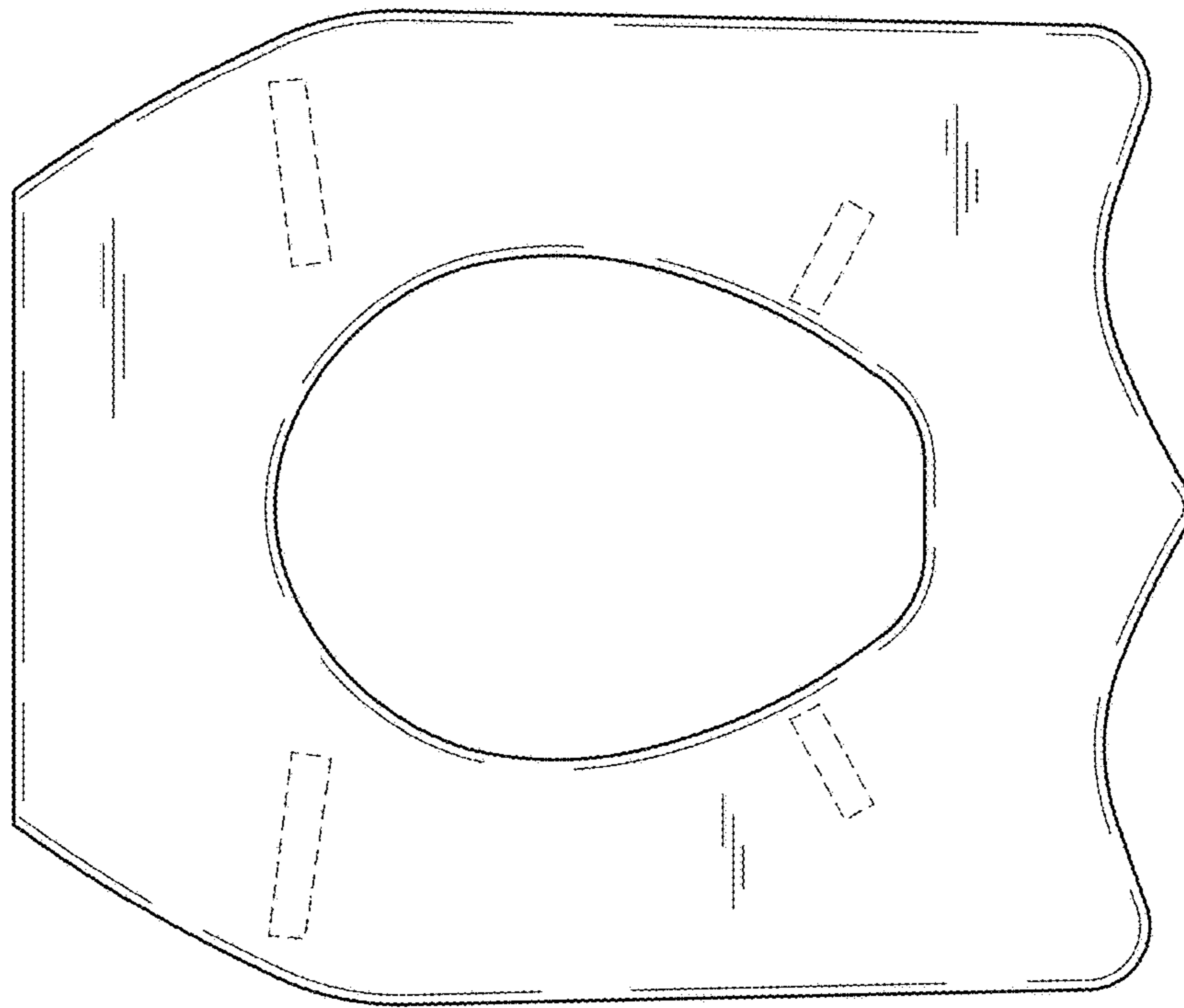

FIG. 3

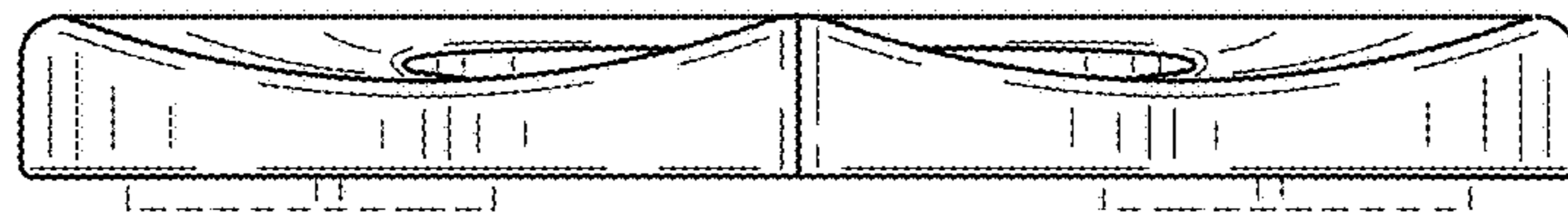

FIG. 4

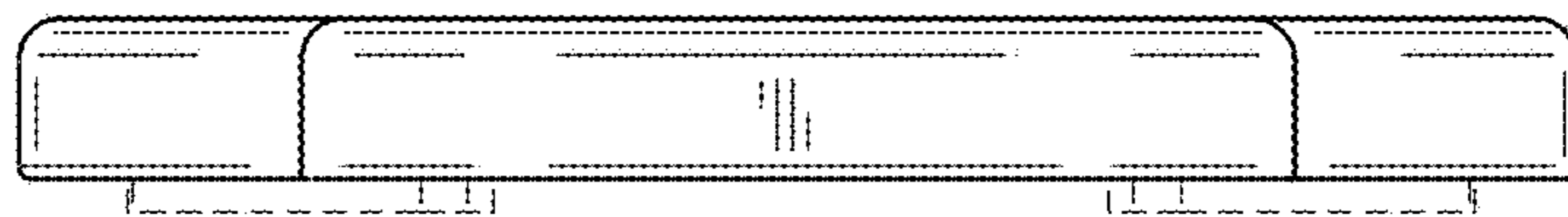

FIG. 5

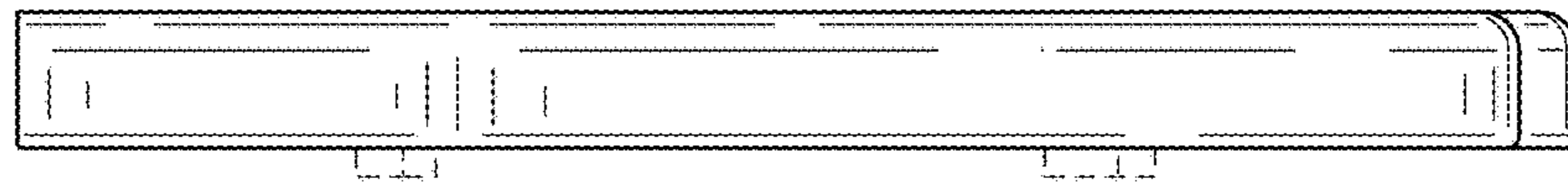

FIG. 6

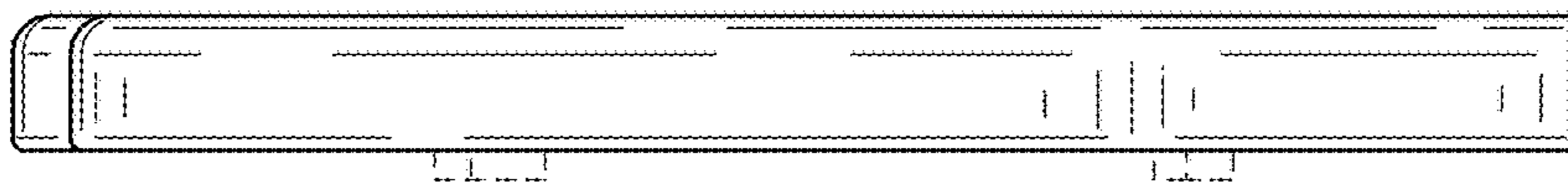

FIG. 7