

US00D866729S

(12) **United States Design Patent** (10) **Patent No.:** **US D866,729 S**  
**Waggoner** (45) **Date of Patent:** **\*\* \*Nov. 12, 2019**

(54) **PORTABLE TOILET**

OTHER PUBLICATIONS

(71) Applicant: **Camco Manufacturing, Inc.**,  
Greensboro, NC (US)

Ref. No. 1, Camco Portable Toilet from Amazon website (www.amazon.com), Mar. 17, 2011, 3 Pages.

(72) Inventor: **Christopher Howard Waggoner**,  
Greensboro, NC (US)

\* cited by examiner

(73) Assignee: **Camco Manufacturing, Inc.**,  
Greensboro, NC (US)

*Primary Examiner* — Lakiya G Rogers

*Assistant Examiner* — John A Voytek

(\*) Notice: This patent is subject to a terminal disclaimer.

(74) *Attorney, Agent, or Firm* — Tuggle Duggins P.A.;  
Blake P. Hurt

(\*\*) Term: **15 Years**

(57) **CLAIM**

(21) Appl. No.: **29/505,748**

The ornamental design for a portable toilet, as shown and described.

(22) Filed: **Jan. 29, 2016**

**DESCRIPTION**

(51) **LOC (12) Cl.** ..... **23-02**

(52) **U.S. Cl.**  
USPC ..... **D23/299**

(58) **Field of Classification Search**  
USPC ..... D23/295-301, 303, 309, 313  
CPC ..... A47K 11/02; A47K 11/026  
See application file for complete search history.

FIG. 1 is a Front, Top, Right perspective view of a portable toilet, showing our new design;  
FIG. 2 is a Front Elevational view according to the invention; and,  
FIG. 3 is a Rear Elevational view according to the invention; and,  
FIG. 4 is a Left Side Elevational view according to the invention; and,  
FIG. 5 is a Right Side Elevational view according to the invention; and,  
FIG. 6 is a Top plan view according to the invention; and,  
FIG. 7 is a Bottom plan view according to the invention; and,  
FIG. 8 is a Front, Top, Right perspective view of a portable toilet with the lid raised, according to the invention.  
The broken lines in FIGS. 3, 4, 5, 6, 7, & 8 are included for Environmental purposes only and form no part of the claimed design.

(56) **References Cited**

U.S. PATENT DOCUMENTS

D382,334 S *	8/1997	Kawamura	.....	D23/295
D382,335 S *	8/1997	Kawamura	.....	D23/295
D532,492 S	11/2006	Giese		
D610,241 S *	2/2010	Giovannoni	.....	D23/295
D620,090 S	7/2010	Jenner		
D642,247 S *	7/2011	Jiang	.....	D23/295
D658,277 S *	4/2012	Iranyi	.....	D23/295
D663,391 S *	7/2012	Iranyi	.....	D23/295
D701,949 S *	4/2014	Bates	.....	D23/295
D743,011 S *	11/2015	Woodside	.....	D23/299

**1 Claim, 8 Drawing Sheets**

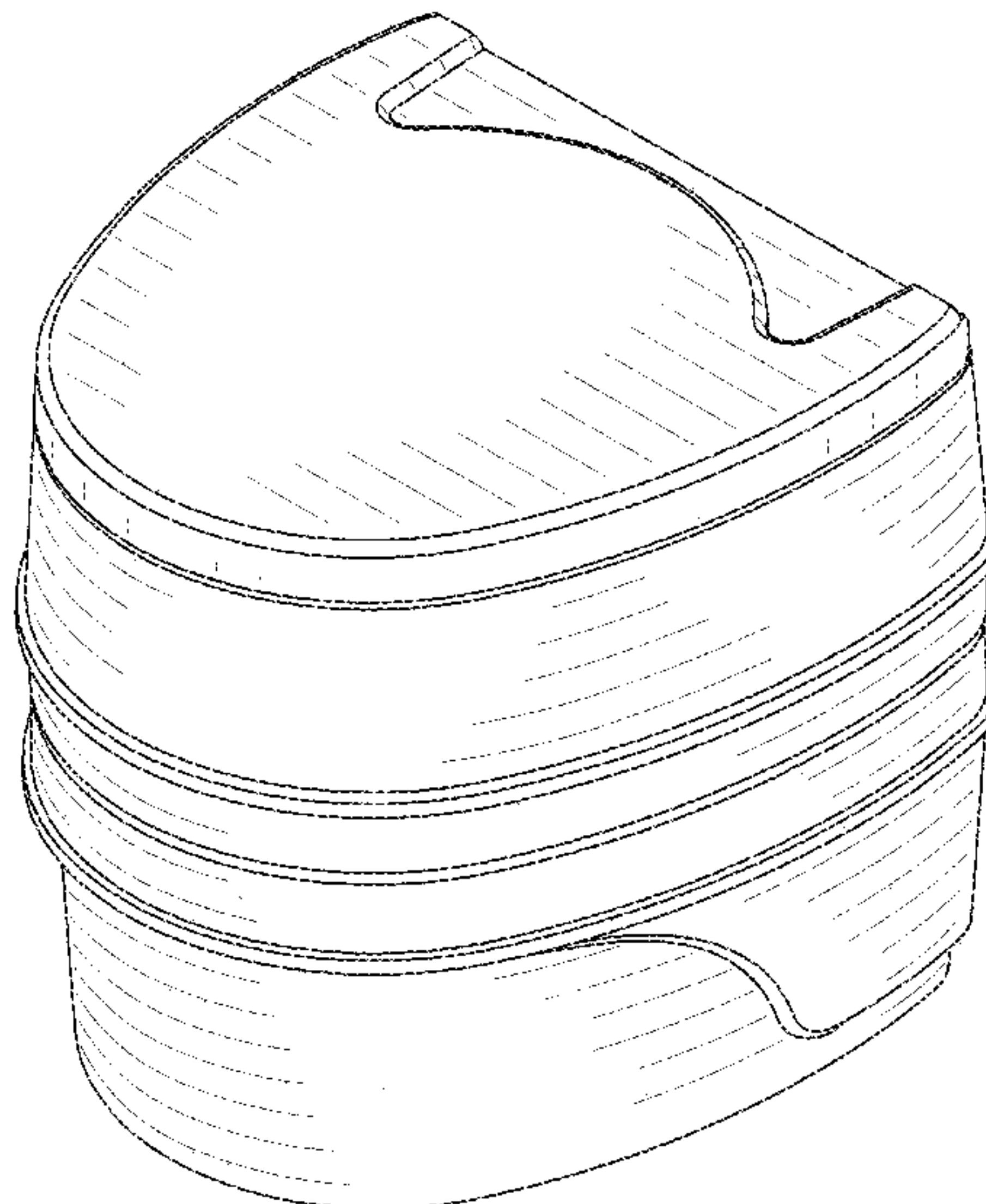

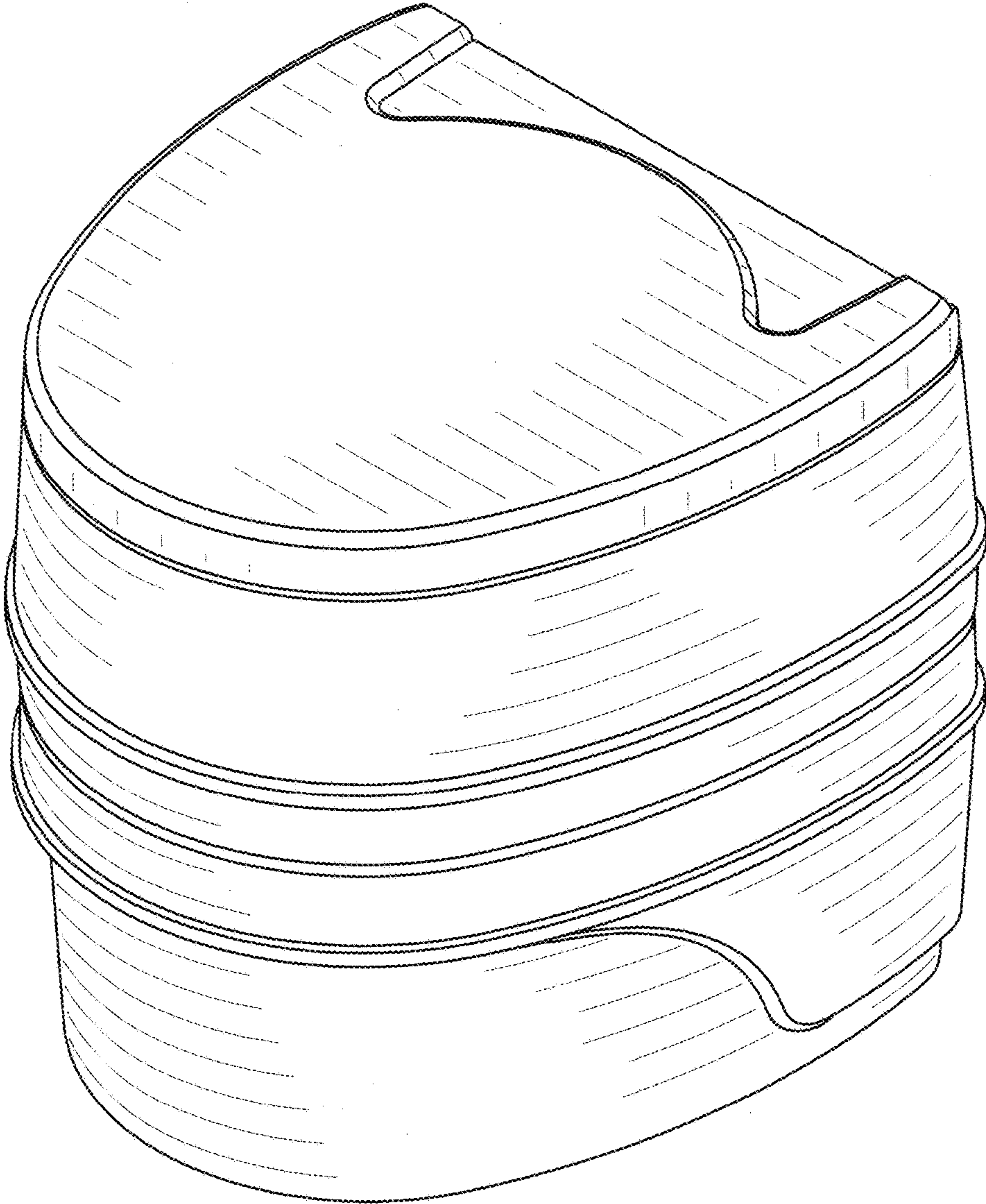

Fig. 1

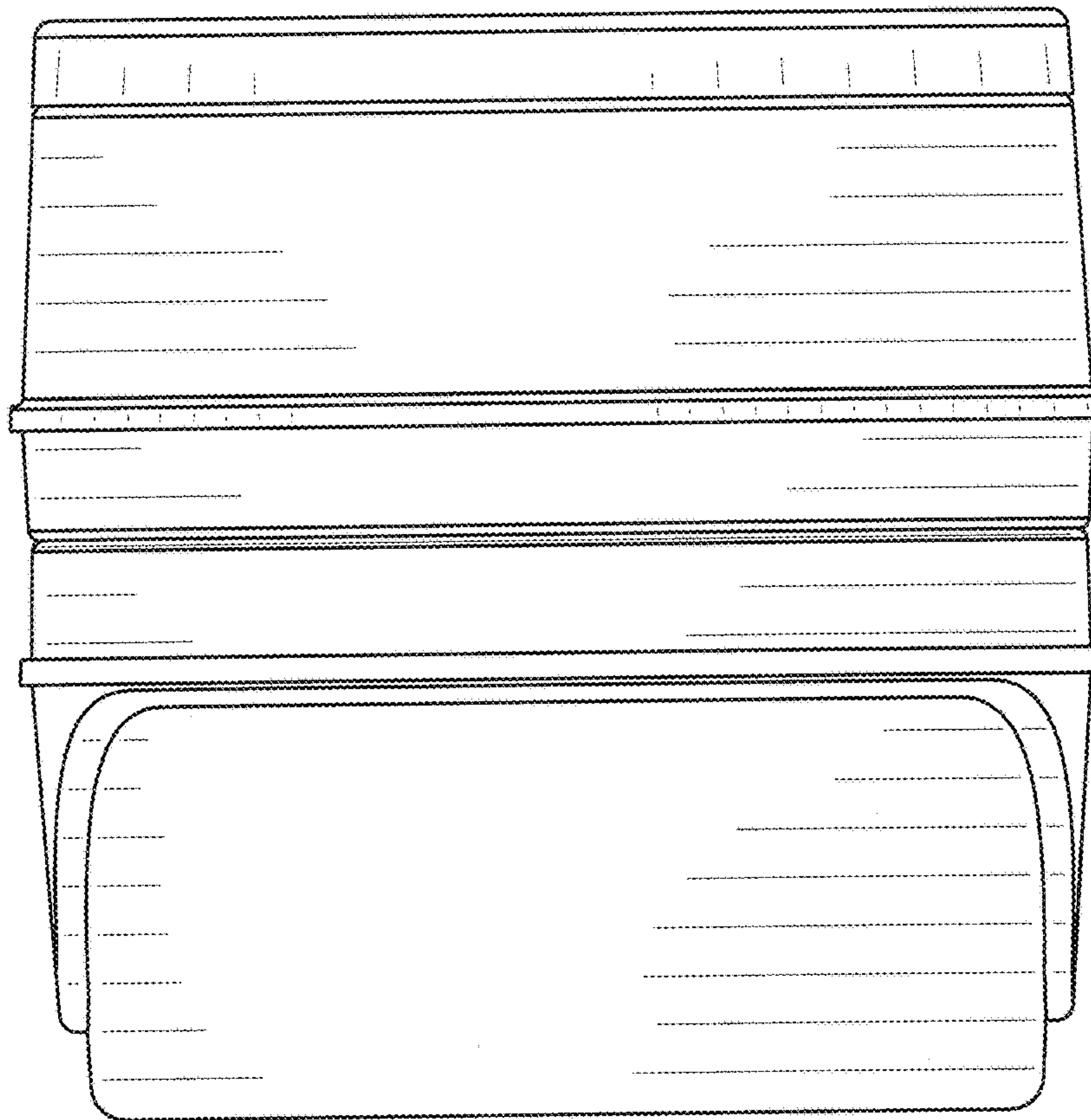

Fig. 2

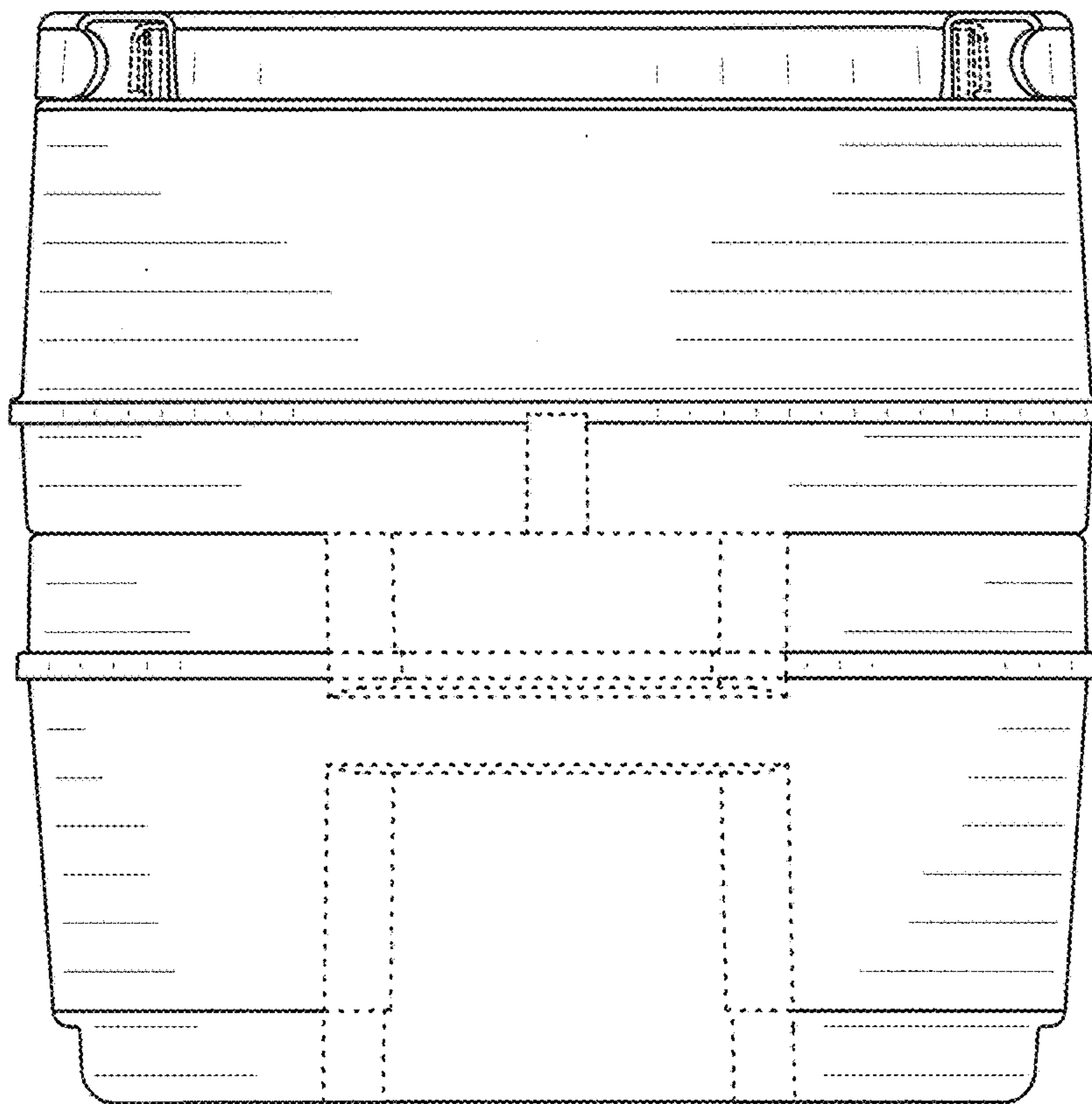

Fig. 3



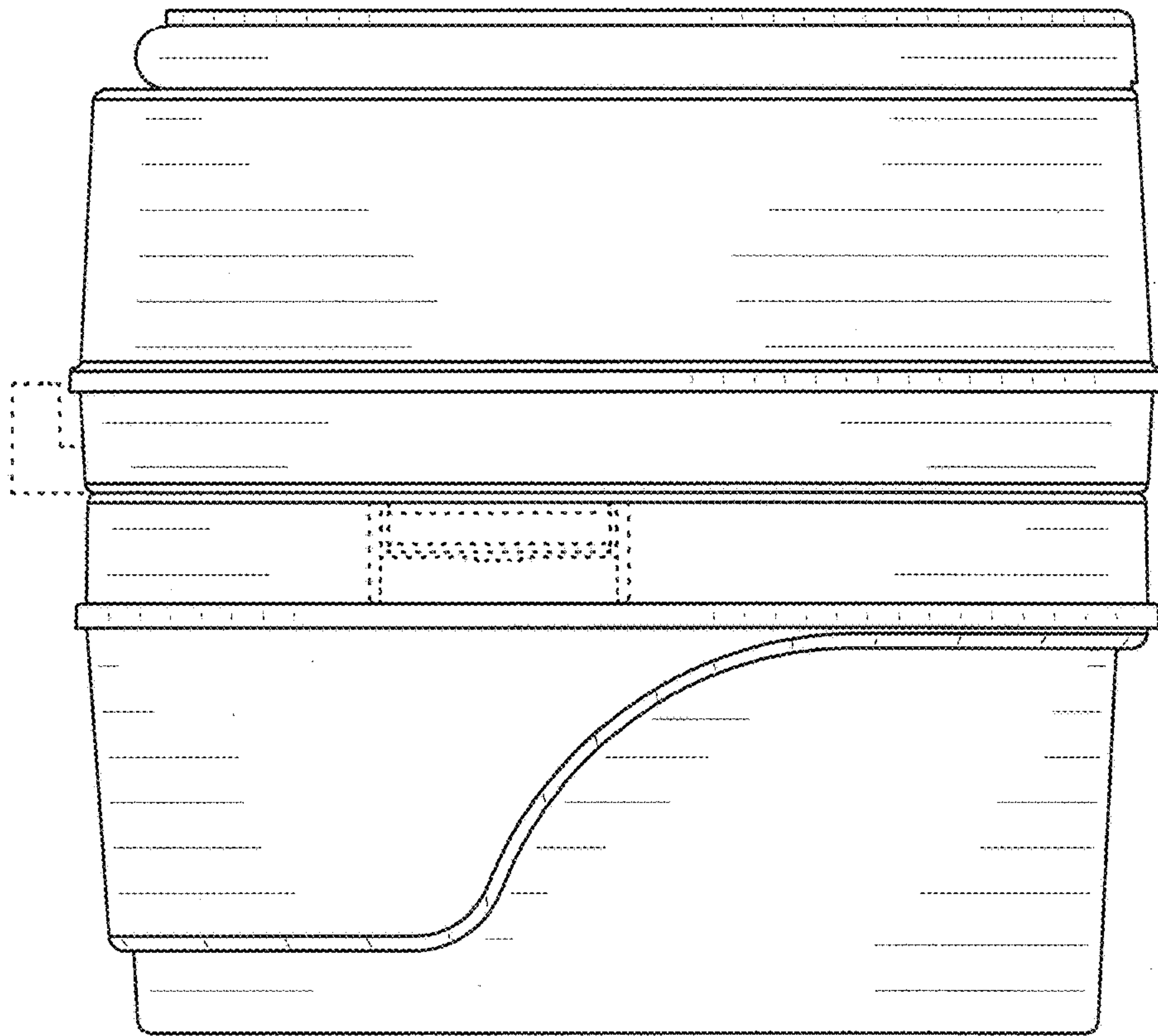

Fig. 4

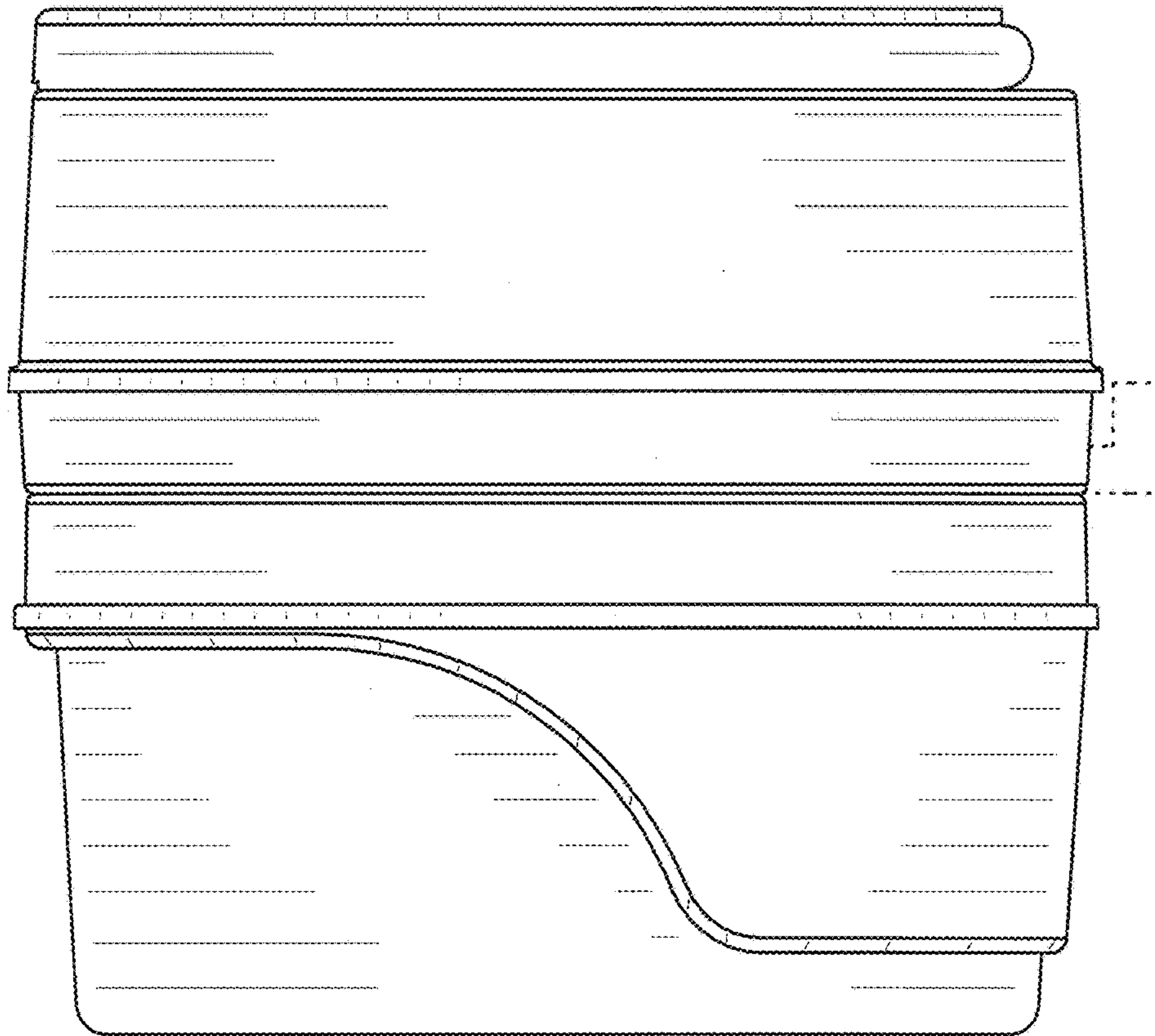

Fig. 5

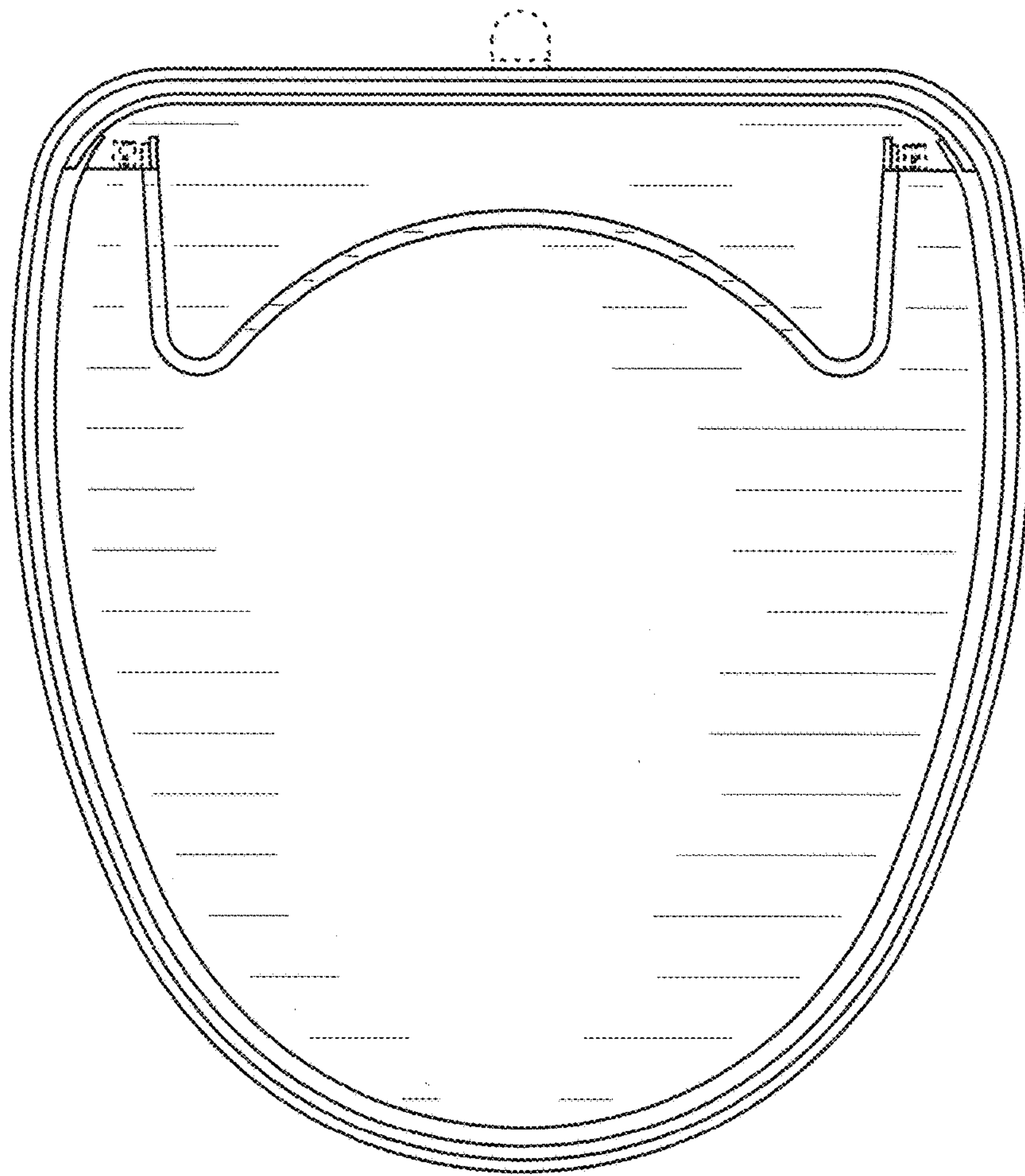

Fig. 6

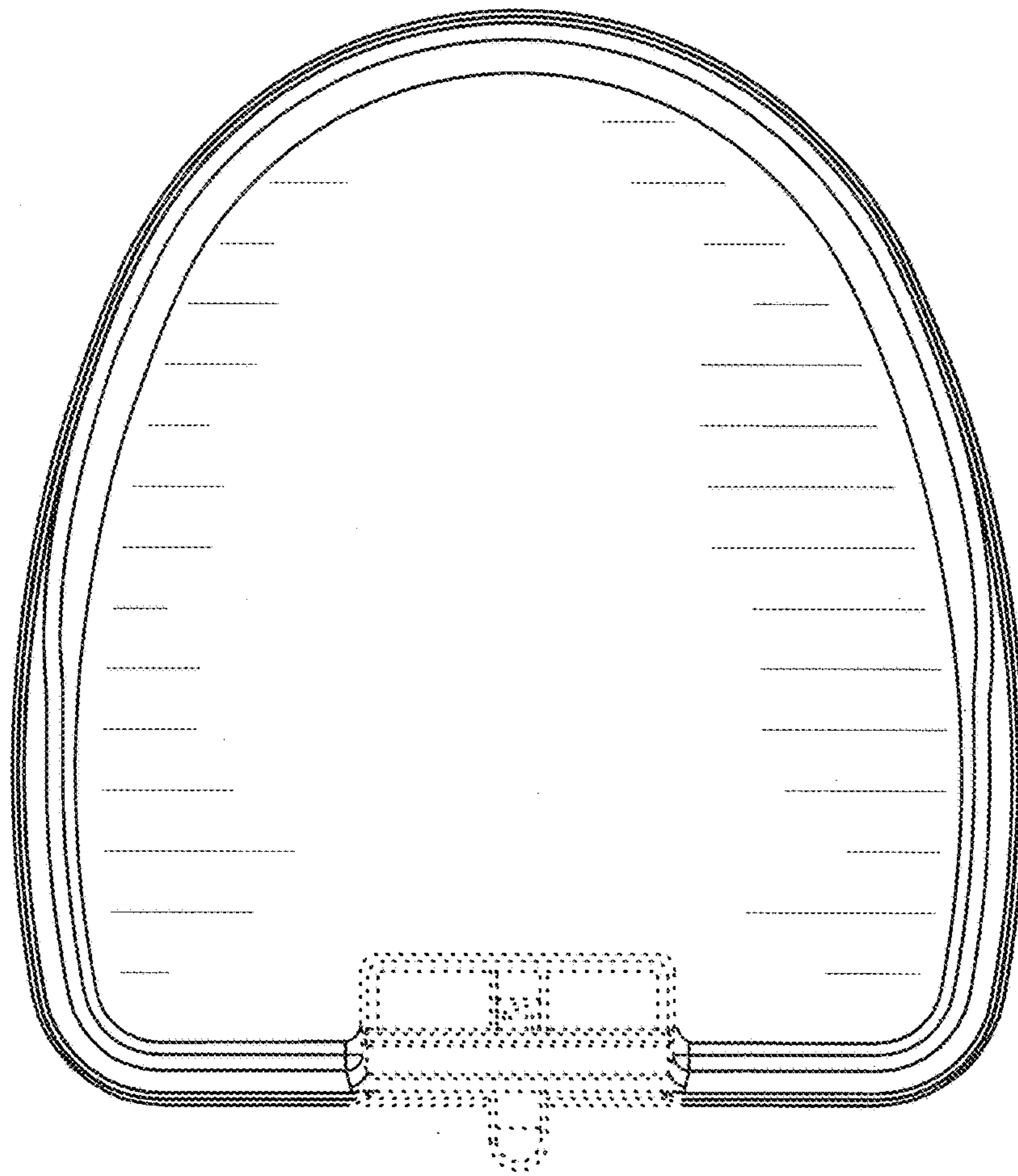

Fig. 7



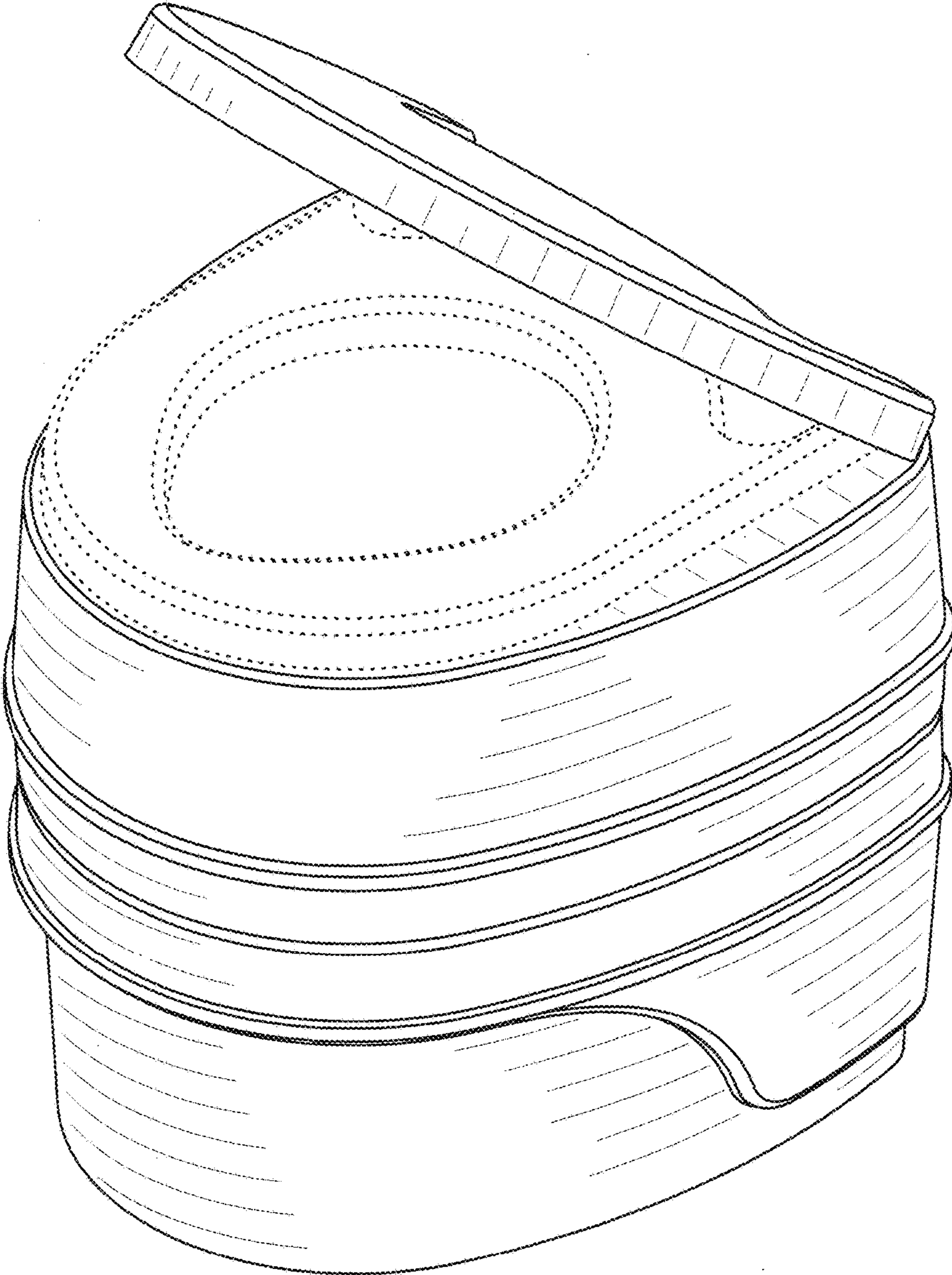

Fig. 8