



US00D866705S

(12) **United States Design Patent**
Larsen

(10) **Patent No.:** **US D866,705 S**

(45) **Date of Patent:** **** Nov. 12, 2019**

(54) **FISHING LURE**

(71) Applicant: **Andrew Larsen**, Hammond, OR (US)

(72) Inventor: **Andrew Larsen**, Hammond, OR (US)

(**) Term: **15 Years**

(21) Appl. No.: **29/664,013**

(22) Filed: **Sep. 20, 2018**

(51) **LOC (12) Cl.** **22-05**

(52) **U.S. Cl.**
USPC **D22/130; D22/132**

(58) **Field of Classification Search**
USPC D22/126-133; 43/26.2, 42.04, 42.31,
43/42.19, 42.47, 42.5; D21/607-608
CPC A01K 85/00; A01K 85/16
See application file for complete search history.

(56) **References Cited**

U.S. PATENT DOCUMENTS

- D237,707 S * 11/1975 Koczorowski D22/132
- D245,785 S * 9/1977 Price D22/130
- D398,036 S * 9/1998 Berryman D22/129

- D406,634 S * 3/1999 Oelerich, Jr. D22/132
- 8,028,465 B1 * 10/2011 Wuensch A01K 85/00
43/42.47
- D673,240 S * 12/2012 Jimenez D22/130
- D691,695 S * 10/2013 Egley D22/129
- D702,806 S * 4/2014 Rinaldi D22/130
- D750,731 S * 3/2016 Dreisbach D22/130

* cited by examiner

Primary Examiner — Catherine R Oliver-Garcia

(74) *Attorney, Agent, or Firm* — Mark S Hubert

(57) **CLAIM**

I claim the ornamental design for the fishing lure, as shown and described.

DESCRIPTION

FIG. 1 is a perspective view of the fishing lure showing my new design;
 FIG. 2 is a left side view of the fishing lure;
 FIG. 3 is a right side view of the fishing lure;
 FIG. 4 is a rear view of the fishing lure;
 FIG. 5 is a front view of the fishing lure;
 FIG. 6 is a top view of the fishing lure; and,
 FIG. 7 is a bottom view of the fishing lure.

1 Claim, 7 Drawing Sheets

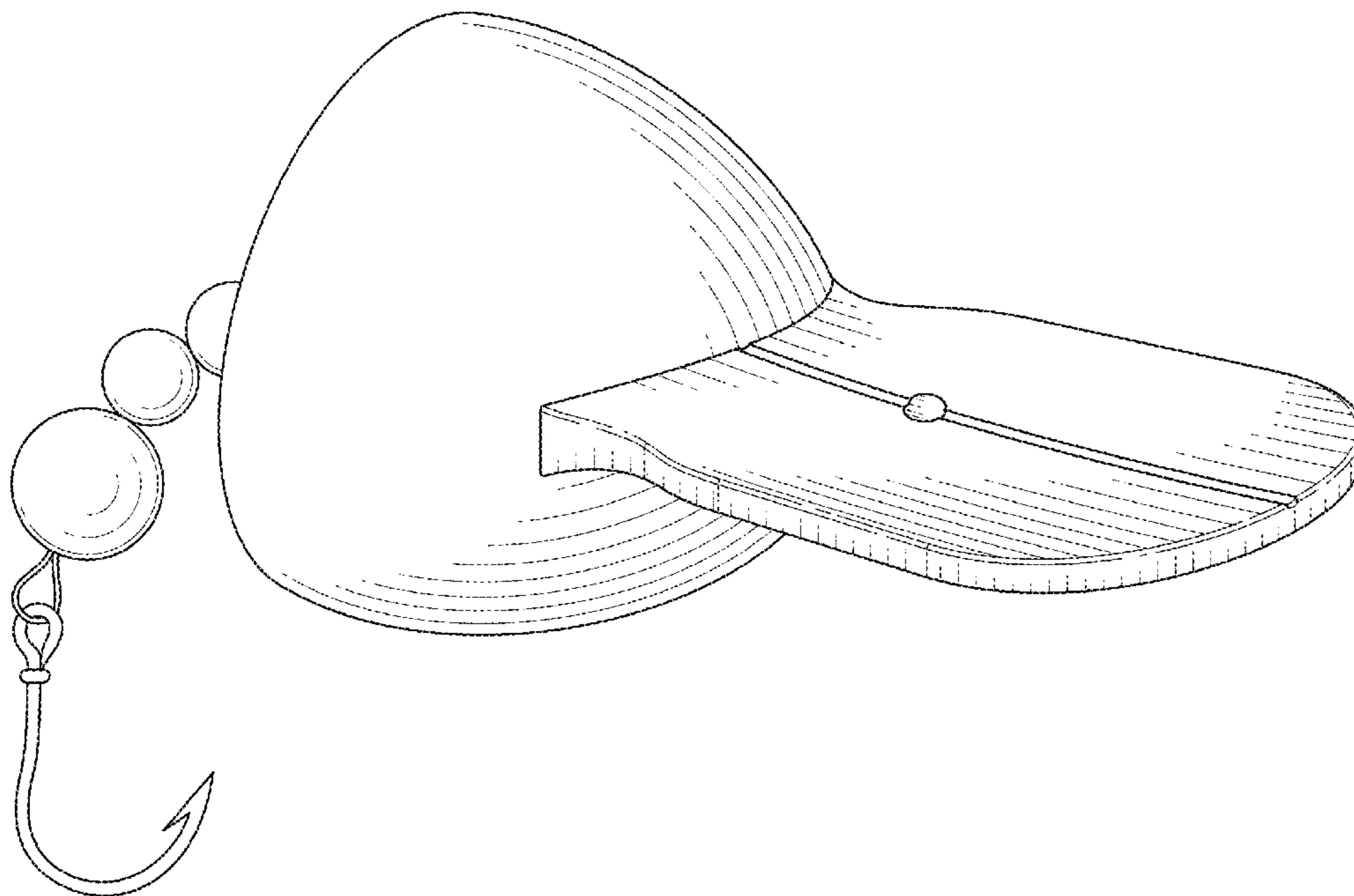

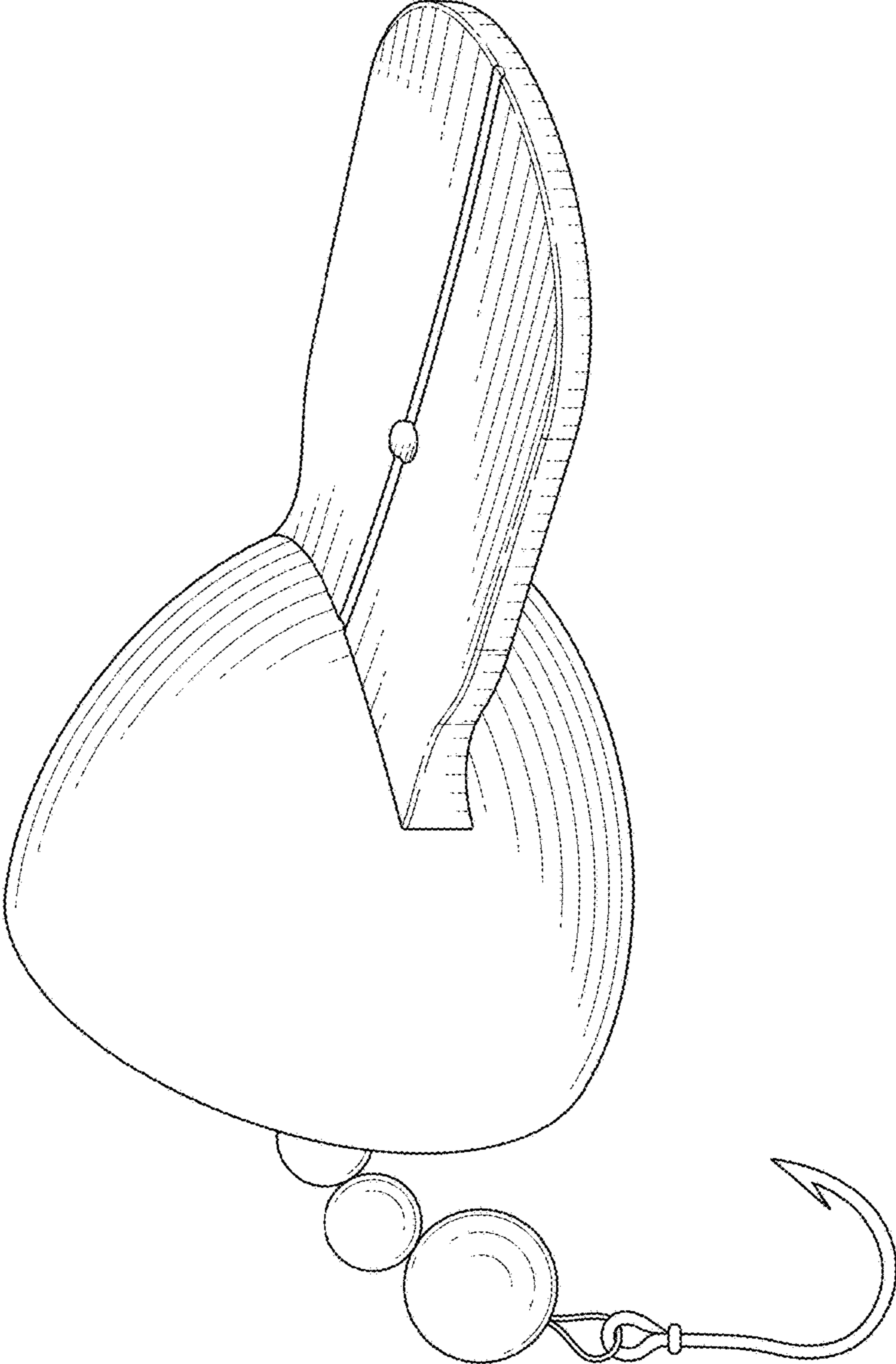

FIG. 1

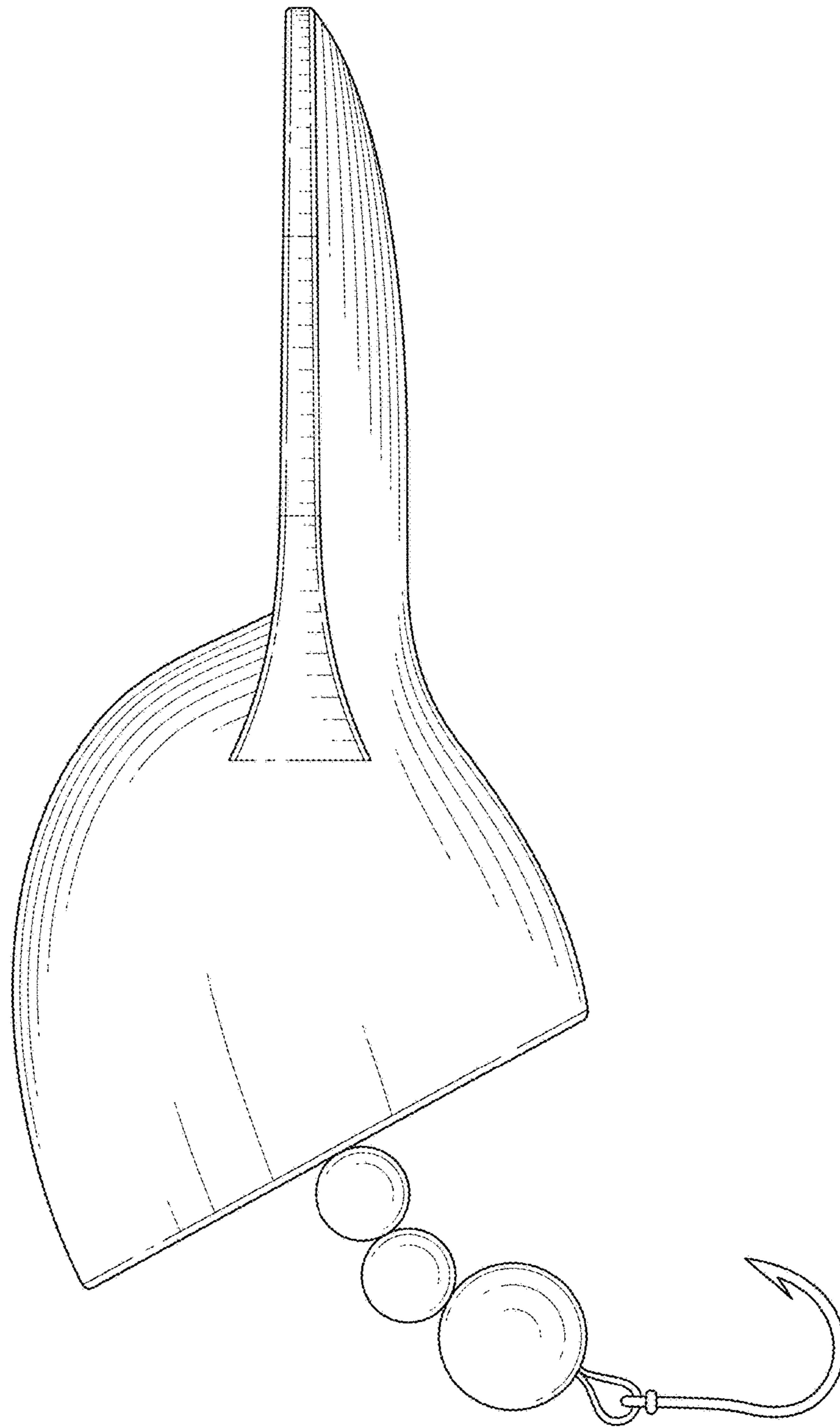

FIG. 2

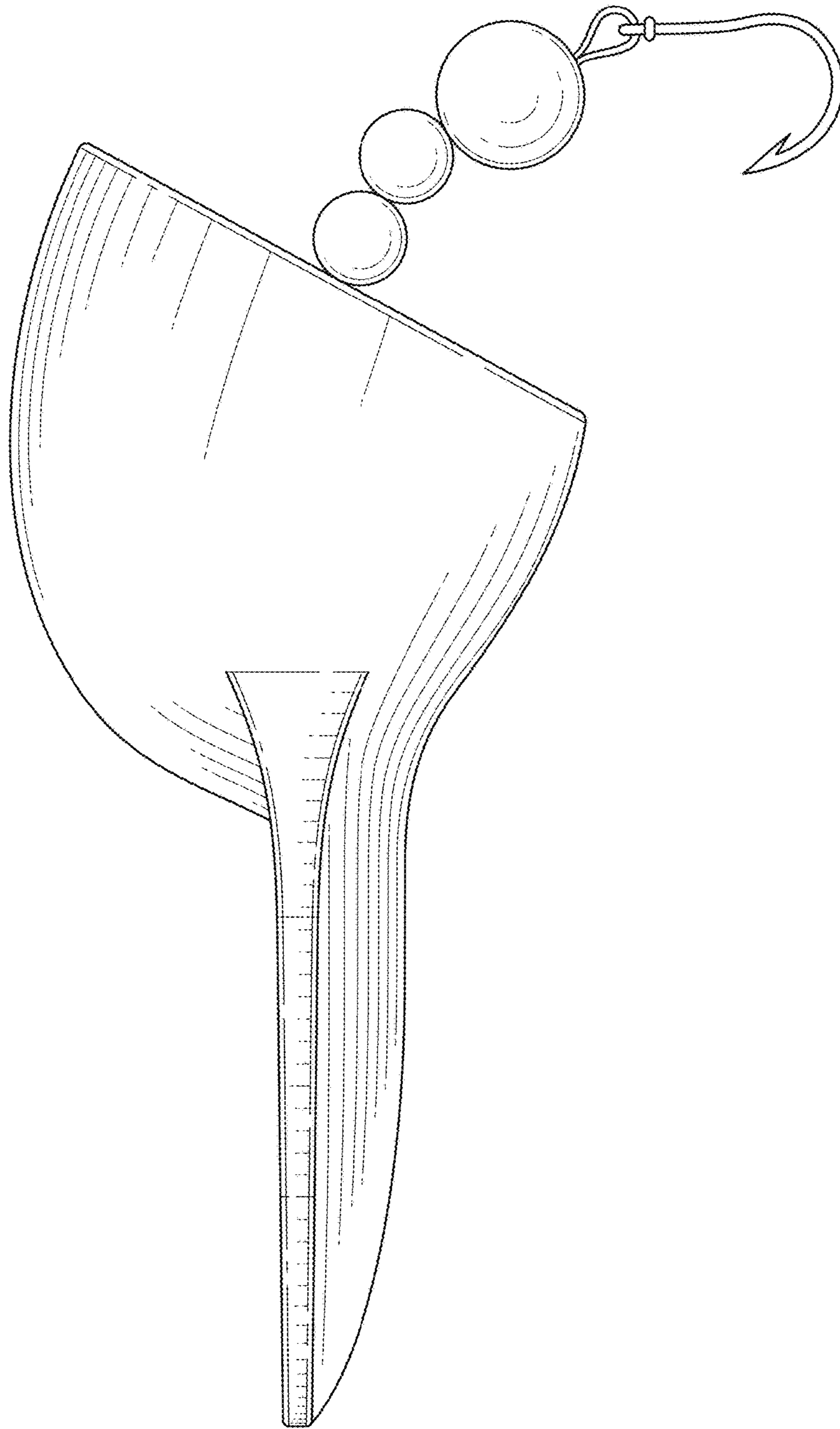

FIG. 3

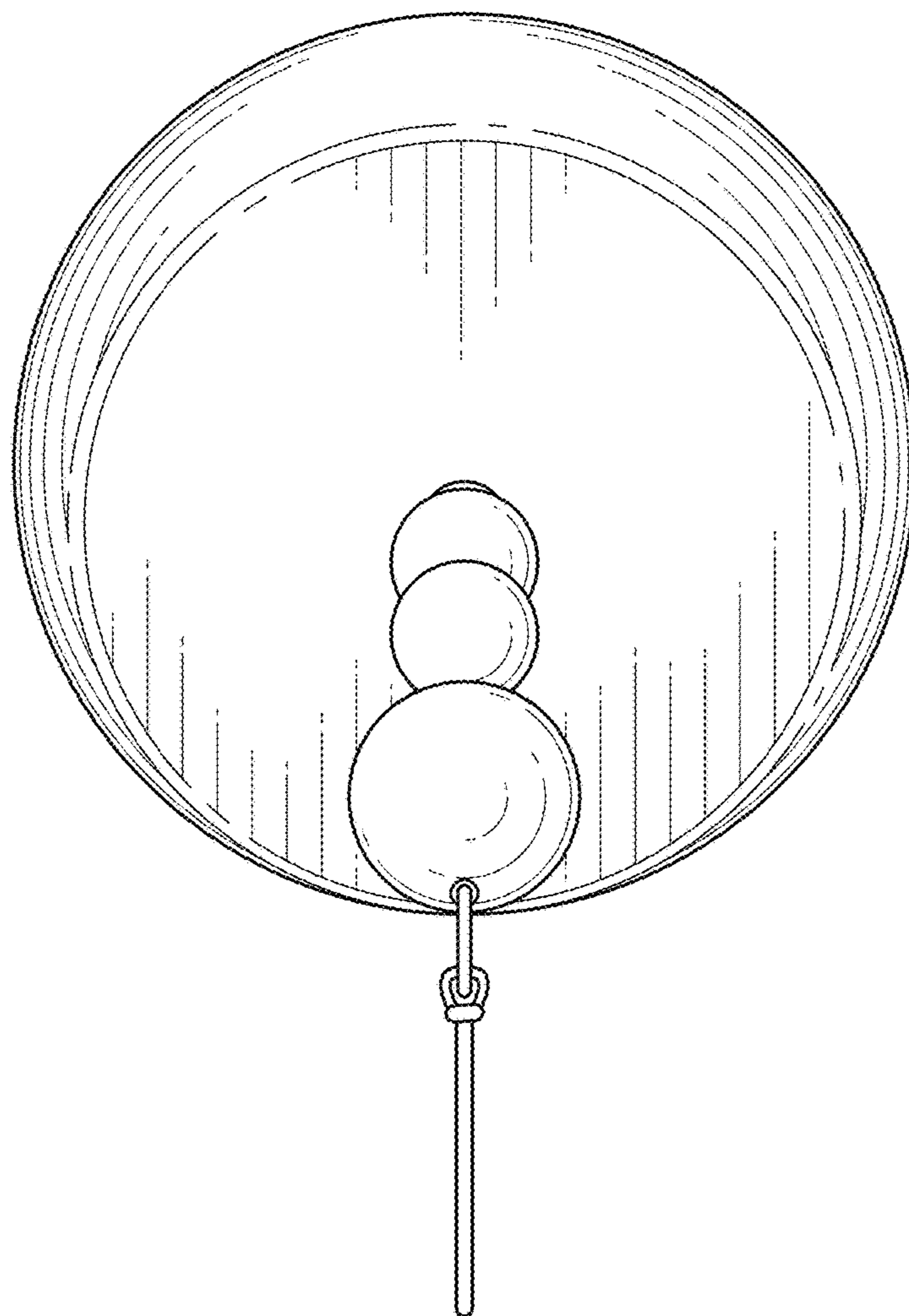

FIG. 4

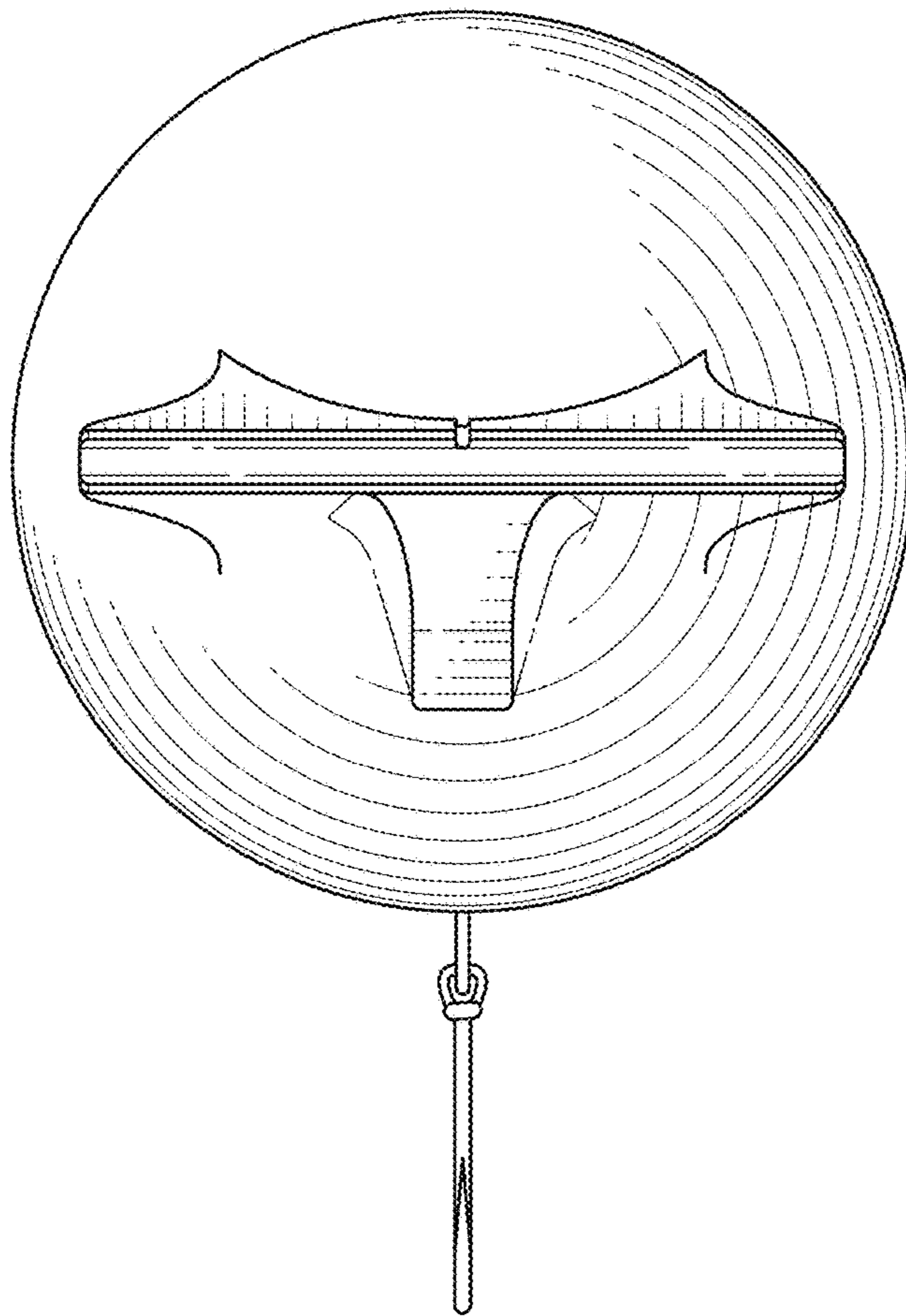

FIG. 5

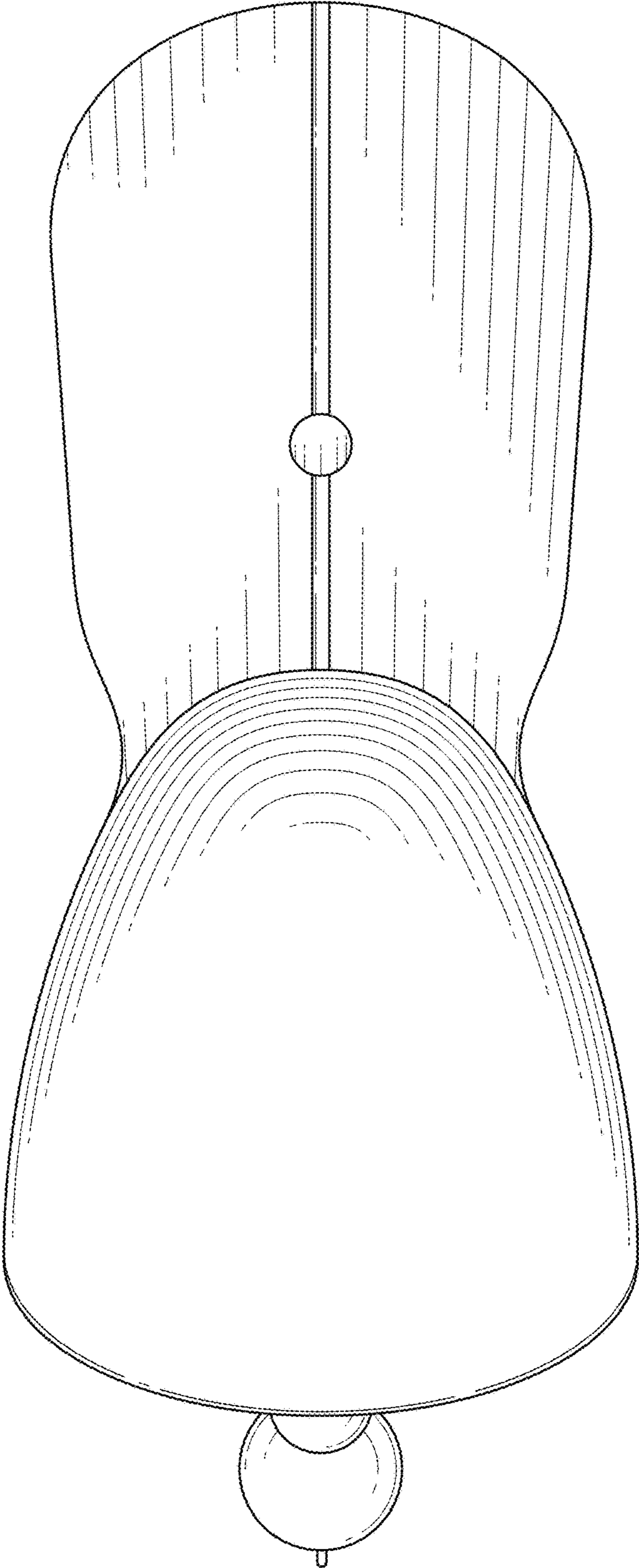

FIG. 6

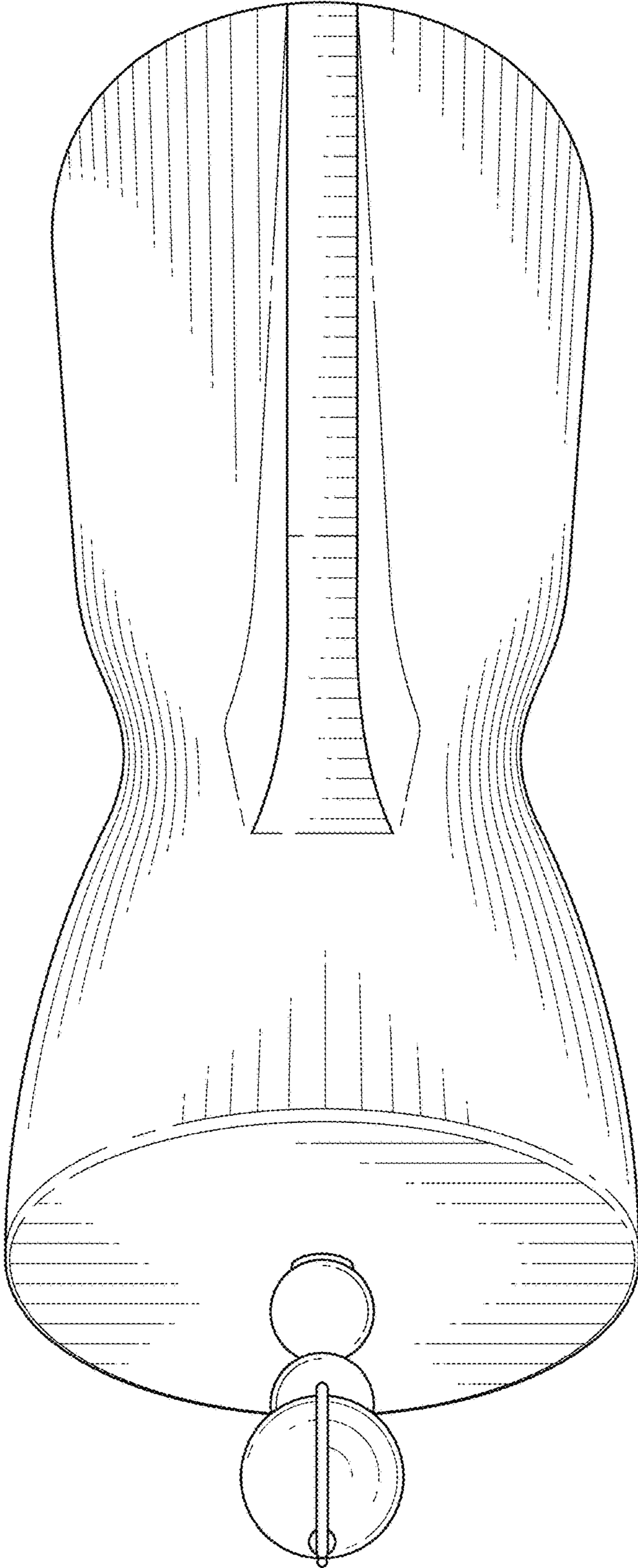

FIG. 7