

US00D866688S

(12) **United States Design Patent** (10) **Patent No.:** **US D866,688 S**  
**Zhang et al.** (45) **Date of Patent:** **\*\* Nov. 12, 2019**

(54) **JUMP ROPE HANDLE**

(71) Applicant: **Web Guidz, LLC**, Wenatchee, WA (US)

(72) Inventors: **Neng wen Zhang**, Dongguan (CN); **Matthew Thomas Hopkins**, Leavenworth, WA (US)

(73) Assignee: **Web Guidz, LLC**, Wenatchee, WA (US)

(\*\*) Term: **15 Years**

(21) Appl. No.: **29/659,894**

(22) Filed: **Aug. 13, 2018**

(51) **LOC (12) Cl.** ..... **21-02**

(52) **U.S. Cl.**  
USPC ..... **D21/694**

(58) **Field of Classification Search**  
USPC ..... D21/672, 756, 662, 757, 684; D22/117; D7/684, 649; D26/38, 49; D8/14, 303, D8/373; 482/82, 49; D15/66; D9/621; D19/77  
CPC ... A63B 5/20; A63B 2208/12; A63B 21/4035; A63B 2071/0625; A63B 2207/02; A63B 5/205; A63B 53/14; Y10T 16/476; Y10T 74/20828  
See application file for complete search history.

(56) **References Cited**

U.S. PATENT DOCUMENTS

4,177,985 A \* 12/1979 Hlasnicek ..... A63B 5/20 482/110  
4,593,899 A \* 6/1986 Miller ..... A63B 5/20 16/430  
4,801,137 A \* 1/1989 Douglass ..... A63B 5/20 482/108  
4,934,691 A \* 6/1990 Rudd ..... A63B 23/03516 482/126

7,462,140 B1 \* 12/2008 Lombardozi ..... A63B 5/20 482/108  
D690,783 S \* 10/2013 Chen ..... D21/672  
D691,692 S \* 10/2013 Sheikh ..... D22/117  
D695,873 S \* 12/2013 Sheikh ..... D22/117  
D725,202 S \* 3/2015 Hunt ..... D21/662  
2015/0224355 A1 \* 8/2015 Holland ..... A61F 7/10 482/82

(Continued)

OTHER PUBLICATIONS

Elite Surge 3.0 by EliteSRS Fiutness dated Jun. 17, 2016. Found online [Jul. 17, 2019] <https://www.elitesrsfitness.com/collections/jump-ropes/products/elite-surge-crossfit-speed-rope> (Year: 2016).\*

(Continued)

*Primary Examiner* — Ryan Harvey  
(74) *Attorney, Agent, or Firm* — Jaffery Watson Mendonsa & Hamilton LLP

(57) **CLAIM**  
We claim the ornamental design for a jump rope handle, as shown and described.

DESCRIPTION

FIG. 1 is a perspective view of a jump rope handle;  
FIG. 2 is a perspective view thereof;  
FIG. 3 is a right side view thereof;  
FIG. 4 is a left side view thereof.  
FIG. 5 is a back view thereof;  
FIG. 6 is a front view thereof;  
FIG. 7 is a bottom view thereof; and,  
FIG. 8 is a top view thereof.  
The features illustrated in evenly-spaced dashed lines showing the remainder of the jump rope handle are for environmental purposes only and form no part of the claimed design. Furthermore, the singular screw-like element illustrated in each of FIGS. 1-4 and 8 does not form part of the claimed design.

1 Claim, 5 Drawing Sheets

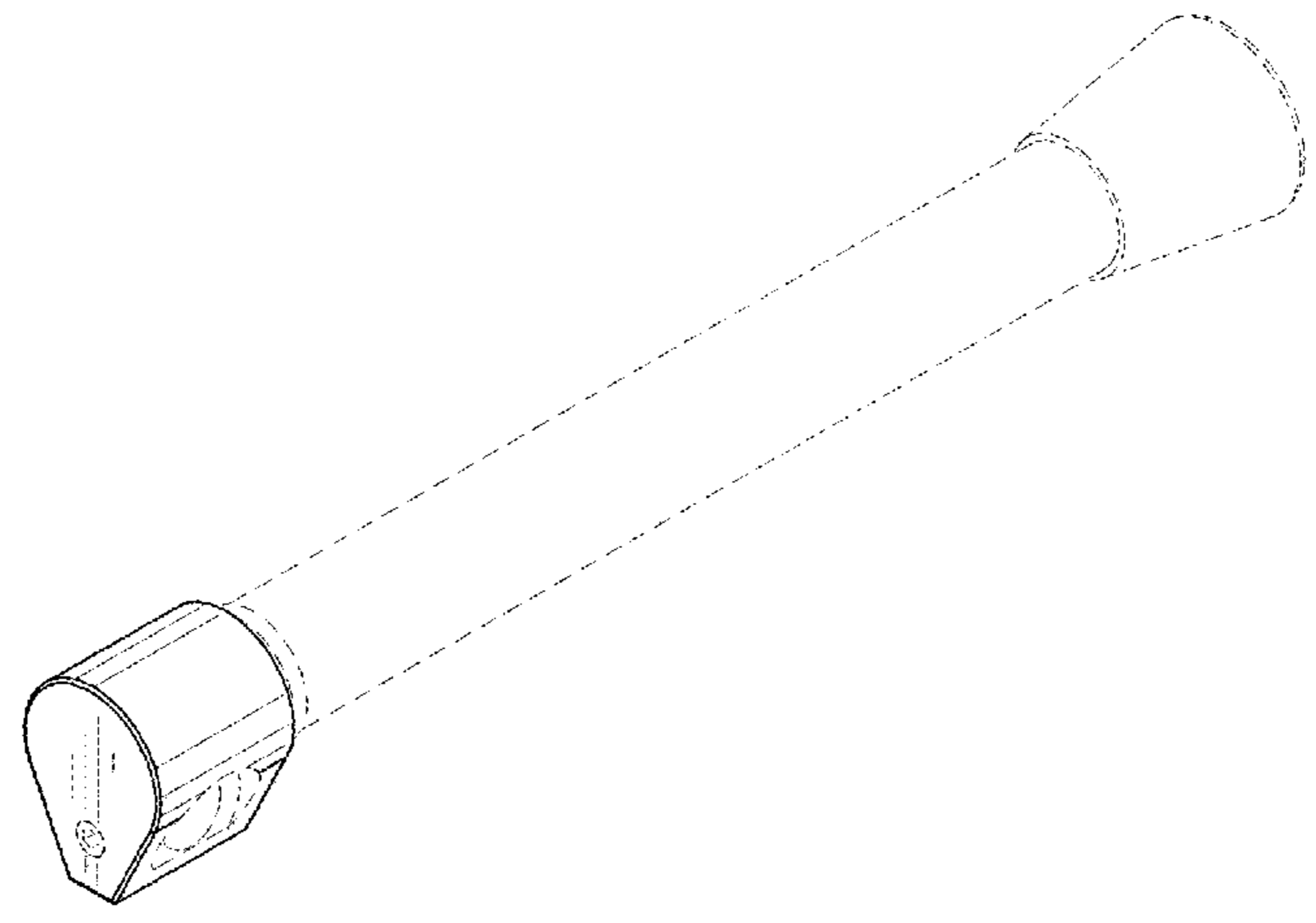

(56)

**References Cited**

U.S. PATENT DOCUMENTS

2015/0335931 A1\* 11/2015 Jordan ..... A63B 5/20  
482/82  
2019/0046825 A1\* 2/2019 Xu ..... A63B 5/20  
2019/0160326 A1\* 5/2019 Zhang ..... A63B 21/4035  
2019/0168092 A1\* 6/2019 Beaver ..... A63B 17/02

OTHER PUBLICATIONS

EliteSRS by EliteSRS dated Apr. 17, 2017. Found online [Jul. 17, 2019][https://www.amazon.com/EliteSRS-Elite-Surge-Jump-Rope/product-reviews/B07992V91F/ref=cm\\_cr\\_getr\\_d\\_paging\\_btm\\_next\\_12?i=Year:2017](https://www.amazon.com/EliteSRS-Elite-Surge-Jump-Rope/product-reviews/B07992V91F/ref=cm_cr_getr_d_paging_btm_next_12?i=Year:2017).\*  
Elite Surge 2.0 and Elite Surge 3.0. Aug. 23, 2019.  
Elite Surge 2.0 and Elite Surge 3.0 (with rope). Aug. 23, 2019.  
Video titled “New 2019 Jump Ropes.” [http://www.youtube.com/watch?v=xSBd0t\\_rEio](http://www.youtube.com/watch?v=xSBd0t_rEio). Published Dec. 11, 2018.

EliteSRS Fitness Equipment for Performance + Style. Apr. 26, 2017. Retrieved from <https://web.archive.org/web/20170426104247/https://www.elitesrsfitness.com/>.  
EliteSRS Ropes + Conditioning-Balance Fitness Equipment-EliteSRS Fitness. Jun. 29, 2017. Retrieved from <https://web.archive.org/web/20170629133413/https://www.elitesrsfitness.com/>.  
EliteSRS Ropes + Conditioning-Balance Fitness Equipment-EliteSRS Fitness. Jul. 6, 2017. Retrieved from <https://web.archive.org/web/20170706144059/https://www.elitesrsfitness.com/>.  
EliteSRS Ropes + Conditioning-Balance Fitness Equipment-EliteSRS Fitness. Aug. 25, 2017. Retrieved from <https://web.archive.org/web/20170825115815/https://www.elitesrsfitness.com/>.  
EliteSRS Ropes + Conditioning-Balance Fitness Equipment-EliteSRS Fitness. Sep. 12, 2017. Retrieved from <https://web.archive.org/web/20170912031845/https://www.elitesrsfitness.com/>.  
EliteSRS Ropes + Conditioning-Balance Fitness Equipment. Sep. 21, 2017. Retrieved from <https://web.archive.org/web/20170921102900/https://www.elitesrsfitness.com/>.  
EliteSRS Ropes + Conditioning-Balance Fitness Equipment. Sep. 30, 2017. Retrieved from <https://web.archive.org/web/20170930010718/https://www.elitesrsfitness.com/>.

\* cited by examiner

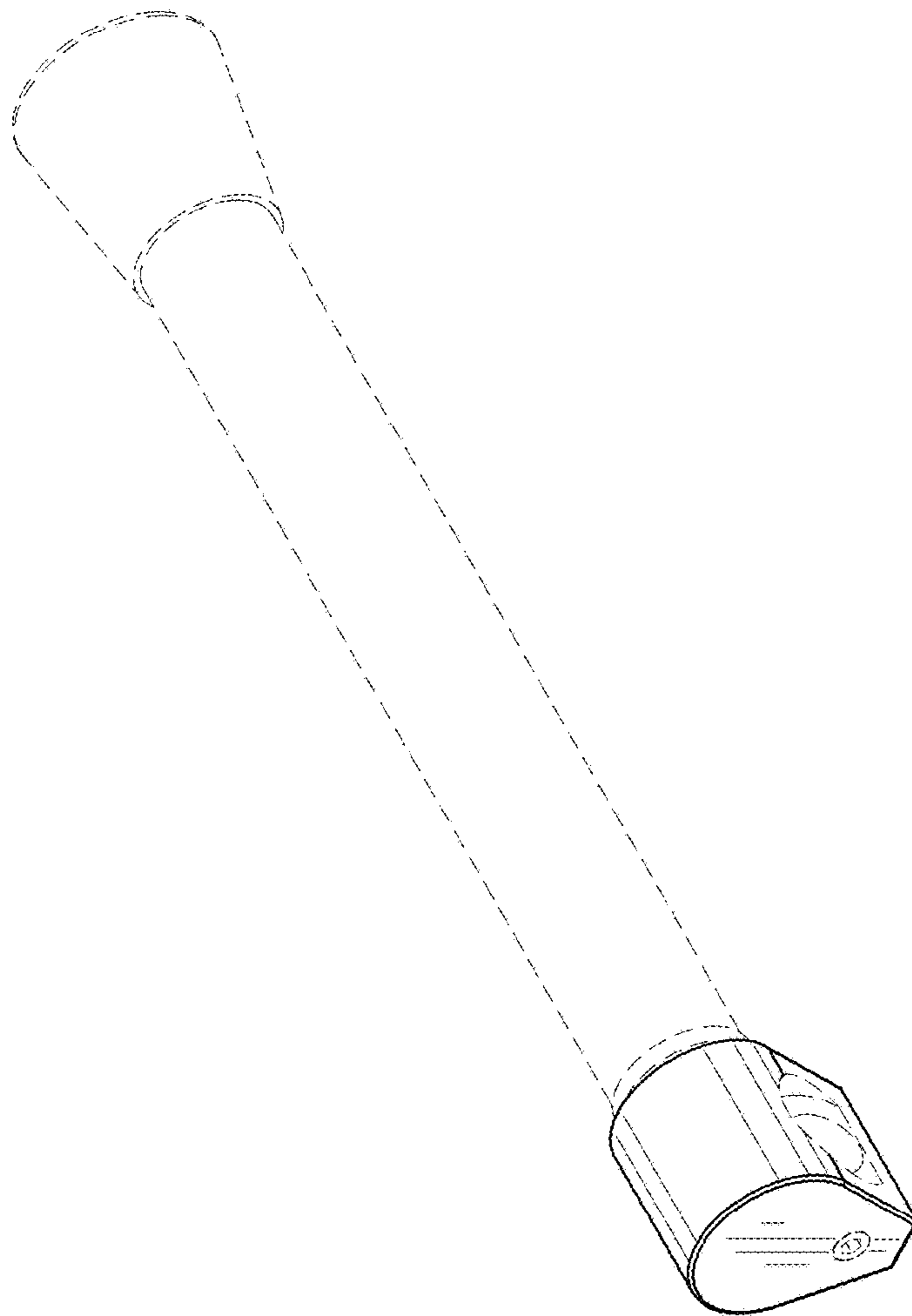

FIG. 1

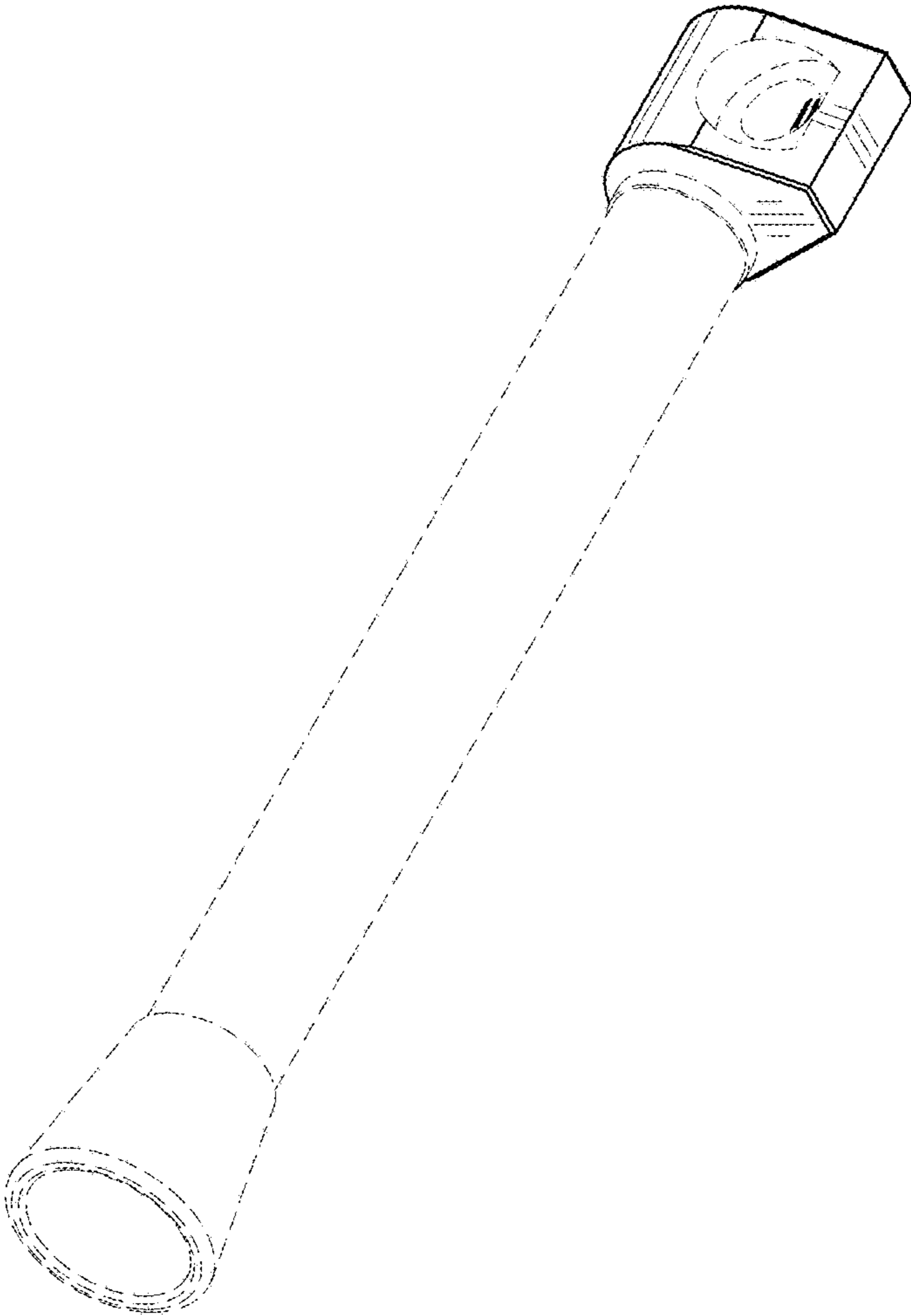

FIG. 2

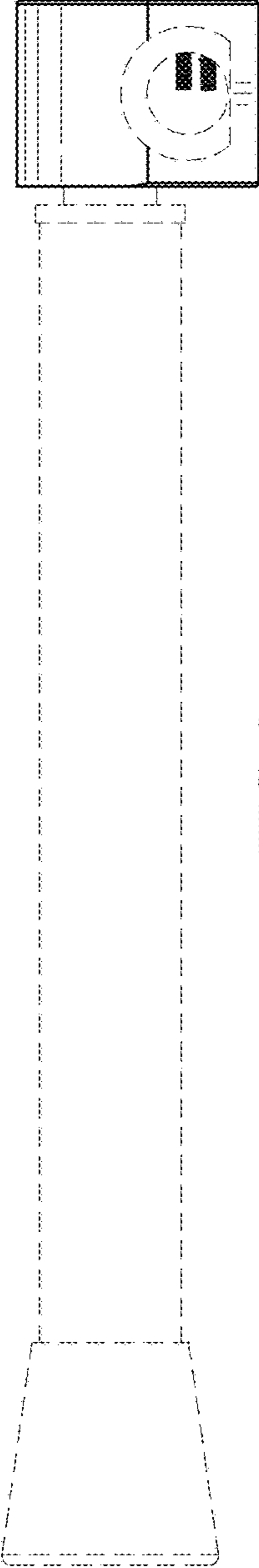

FIG. 3

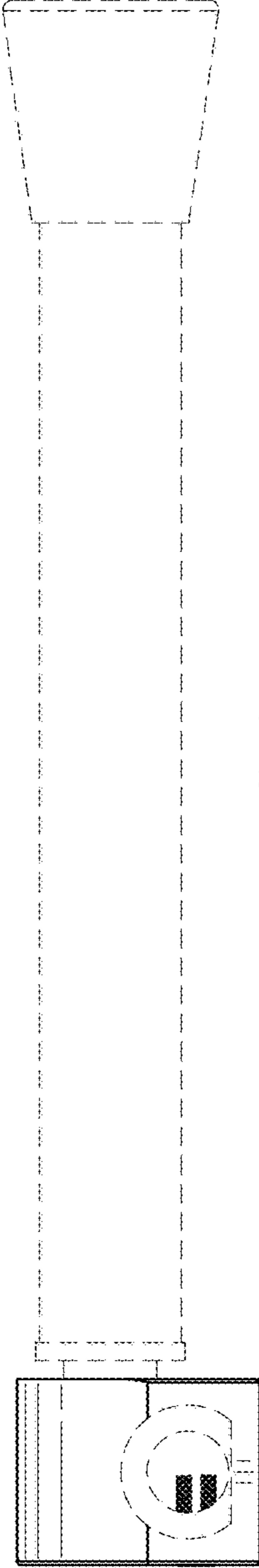

FIG. 4

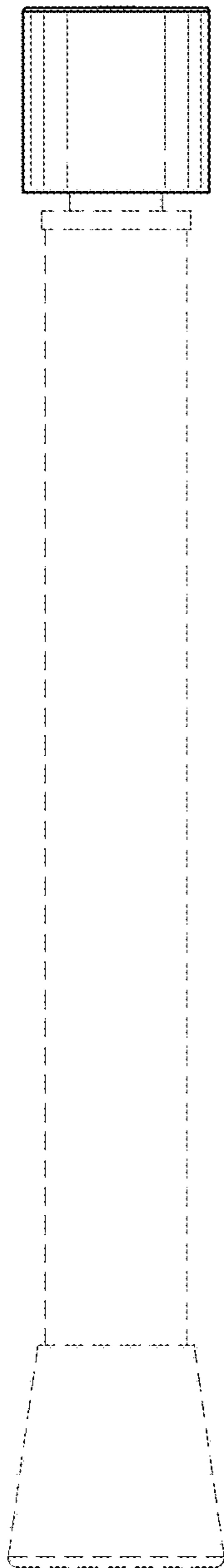

FIG. 5

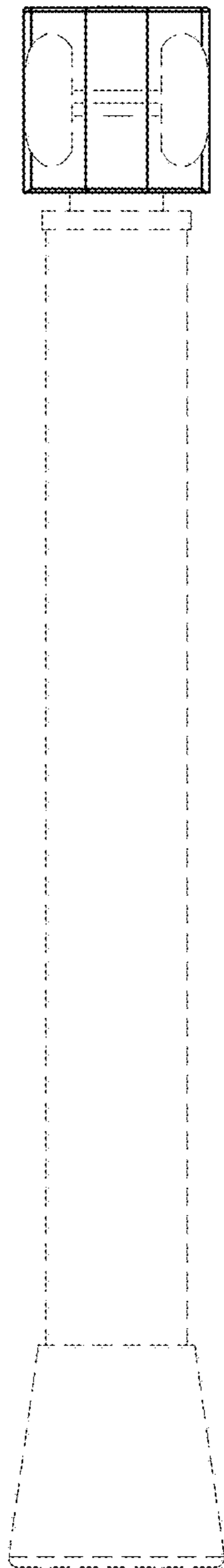

FIG. 6

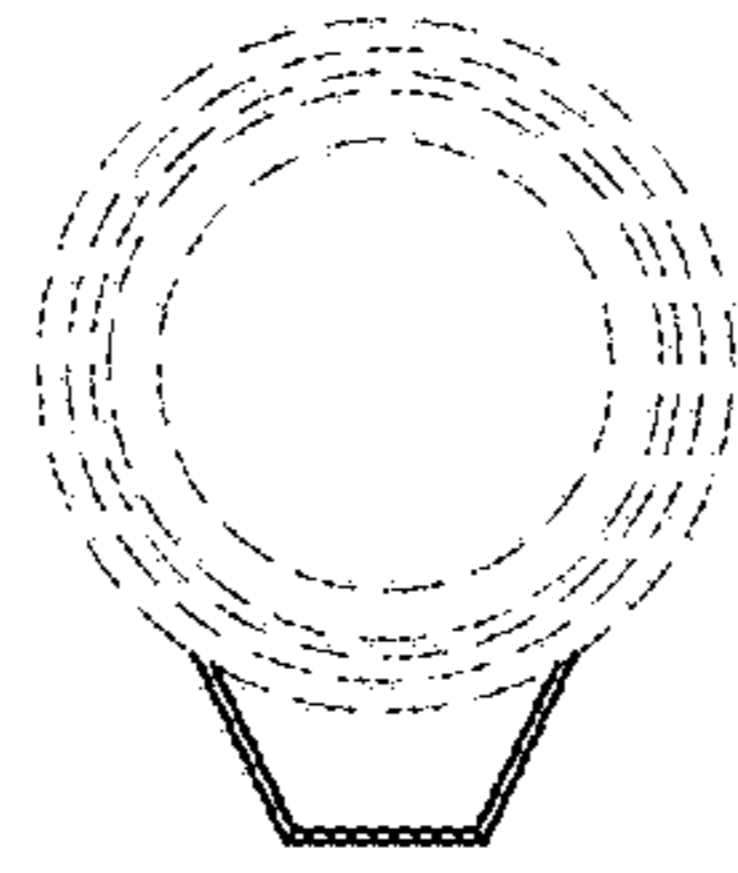

FIG. 7

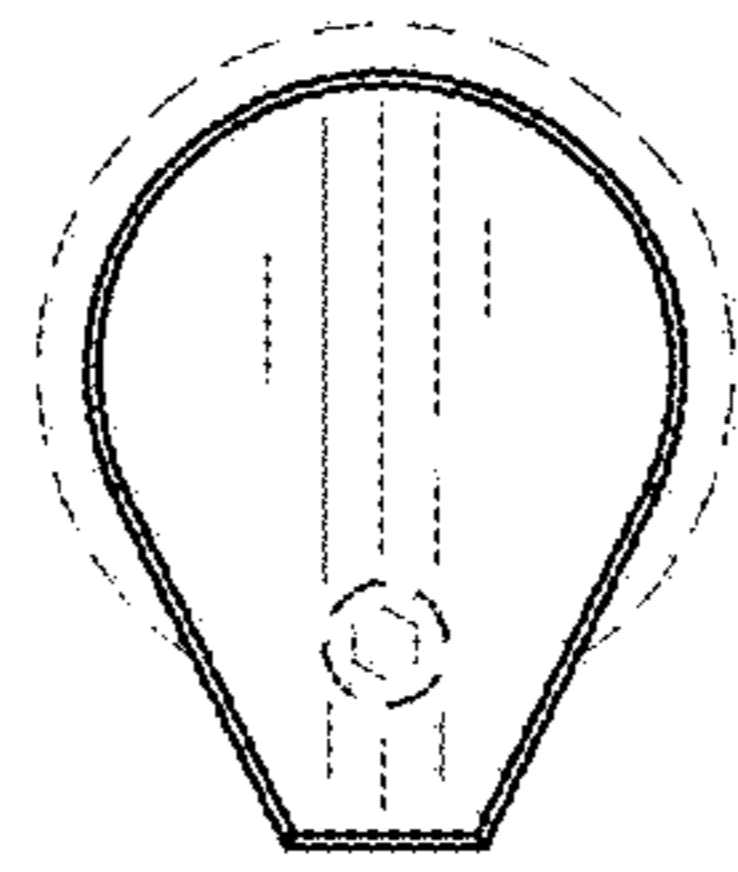

FIG. 8