

US00D866520S

(12) **United States Design Patent** (10) **Patent No.:** **US D866,520 S**  
**Kim et al.** (45) **Date of Patent:** **\*\* \*Nov. 12, 2019**

(54) **SPEAKER**

(71) Applicant: **LG ELECTRONICS INC.**, Seoul (KR)

(72) Inventors: **Hana Kim**, Seoul (KR); **Sanghoon Yoon**, Seoul (KR)

(73) Assignee: **LG Electronics Inc.**, Seoul (KR)

(\*) Notice: This patent is subject to a terminal disclaimer.

(\*\*) Term: **15 Years**

(21) Appl. No.: **35/505,199**

(22) Filed: **Dec. 29, 2017**

(80) **Hague Agreement Data**

Int. Filing Date: **Dec. 29, 2017**

Int. Reg. No.: **DM/099193**

Int. Reg. Date: **Dec. 29, 2017**

Int. Reg. Pub. Date: **Jun. 29, 2018**

(30) **Foreign Application Priority Data**

Jul. 5, 2017 (KR) ..... 30-2017-0030996

(51) **LOC (12) Cl.** ..... **14-03**

(52) **U.S. Cl.**  
USPC ..... **D14/216**

(58) **Field of Classification Search**

USPC ..... D14/167, 168, 170-172, 188, 194-196, D14/204, 207, 209.1, 210-216, 219, 221, D14/222, 224, 239, 496; D10/114.5, 120  
CPC ..... H04R 1/028; H04R 1/10; H04R 1/2803; H04R 1/2826; H04R 1/342; H04R 3/00; H05K 1/0278

See application file for complete search history.

(56) **References Cited**

U.S. PATENT DOCUMENTS

D223,255	S	*	4/1972	Boldt et al.	.....	D14/212
D364,165	S	*	11/1995	Esslinger	.....	D14/213
D364,871	S	*	12/1995	Esslinger	.....	D14/211
D435,540	S	*	12/2000	Peng	.....	D14/216
D563,391	S	*	3/2008	Skurdal	.....	D14/172
D573,586	S	*	7/2008	Prince	.....	D14/204
D598,899	S	*	8/2009	Tkachuk	.....	D14/216
D607,878	S	*	1/2010	Murray	.....	D14/216
D619,119	S	*	7/2010	Graben	.....	D14/216
D687,017	S	*	7/2013	Ashcraft	.....	D14/216
D737,800	S	*	9/2015	Aleksandrov	.....	D14/210
D766,213	S	*	9/2016	Hinokio	.....	D14/216
D786,829	S	*	5/2017	Wang	.....	D14/204
D829,313	S	*	9/2018	Cho	.....	D23/364
D836,610	S	*	12/2018	Yoon	.....	D14/216
D838,257	S	*	1/2019	Manz	.....	D14/216
D838,690	S	*	1/2019	Cheon	.....	D14/216
D842,842	S	*	3/2019	Lee	.....	D14/216
D845,276	S	*	4/2019	Huang	.....	D14/216

\* cited by examiner

*Primary Examiner* — Darlington Ly

(74) *Attorney, Agent, or Firm* — Birch, Stewart, Kolasch & Birch, LLP

(57) **CLAIM**

The ornamental design for a speaker, as shown and described.

**DESCRIPTION**

1. Speaker

**1.1** is a perspective view of a speaker showing our new design;

**1.2** is a front elevation view thereof;

**1.3** is a rear elevation view thereof;

**1.4** is a left side elevation view thereof;

**1.5** is a right side elevation view thereof;

(Continued)

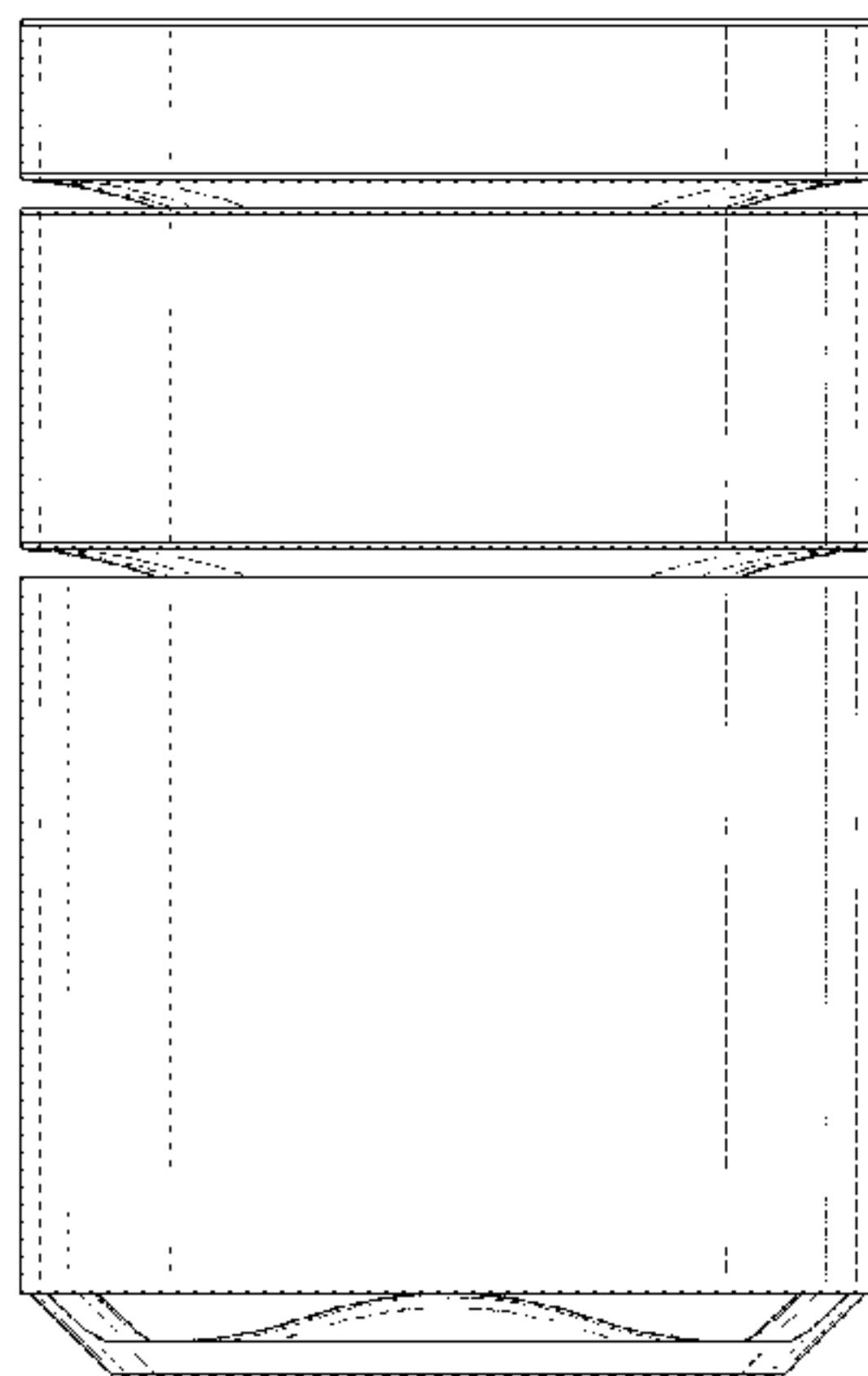

**1.6** is a top plan view thereof; and  
**1.7** is a bottom plan view thereof.  
The broken lines in the drawings illustrate portions of the speaker that form no part of the claimed design.

**1 Claim, 6 Drawing Sheets**

1.1

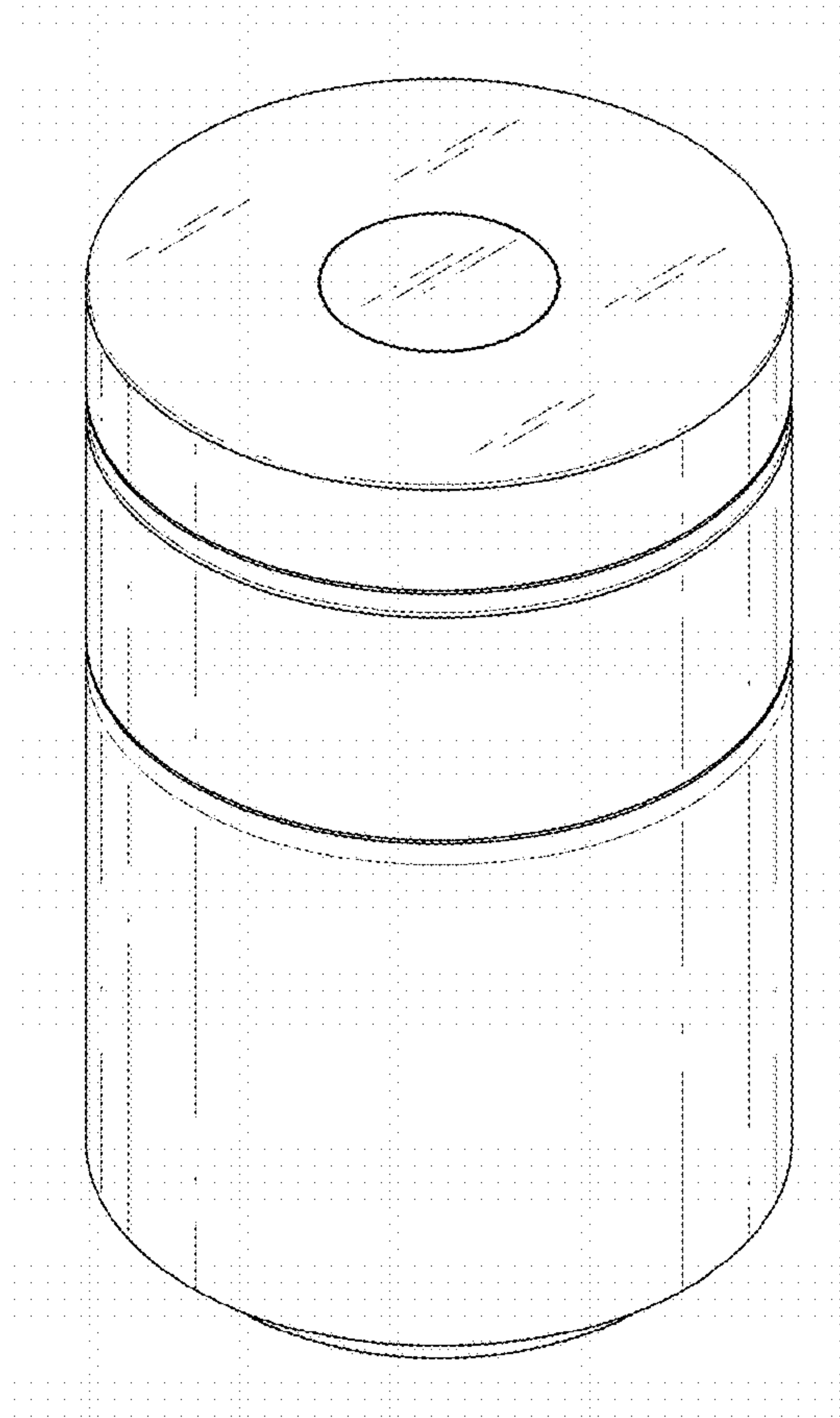

1.2

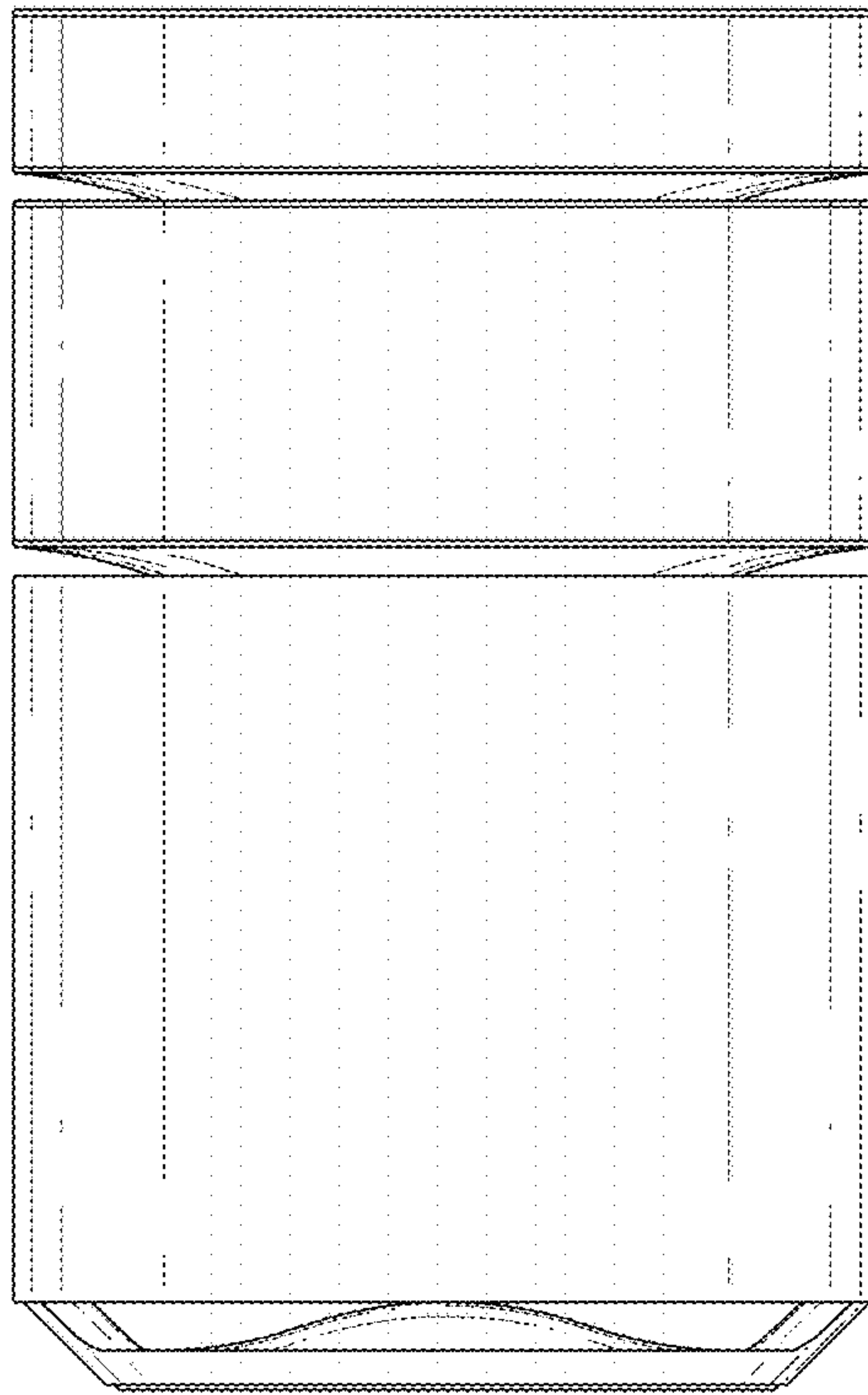

1.3

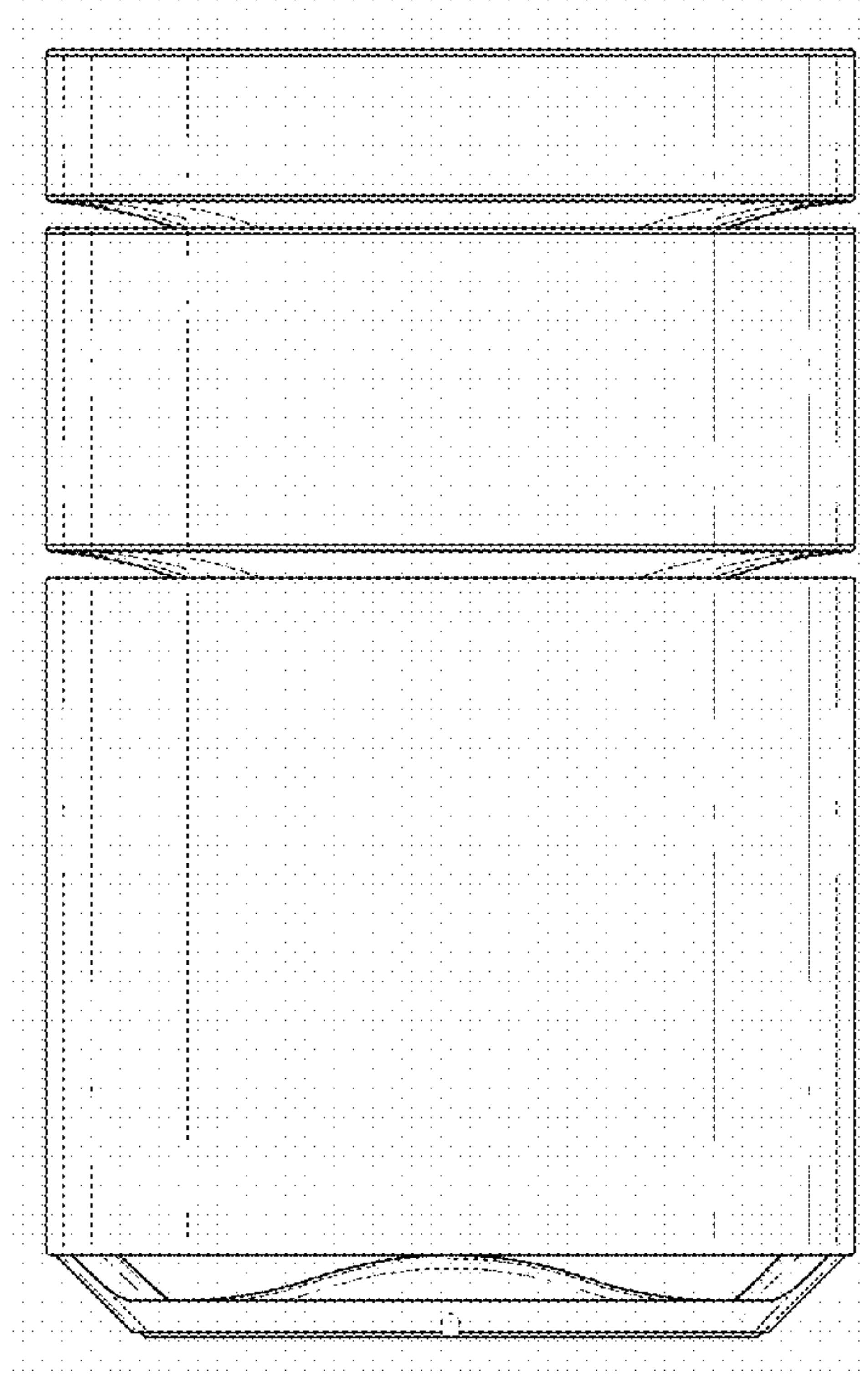

1.4

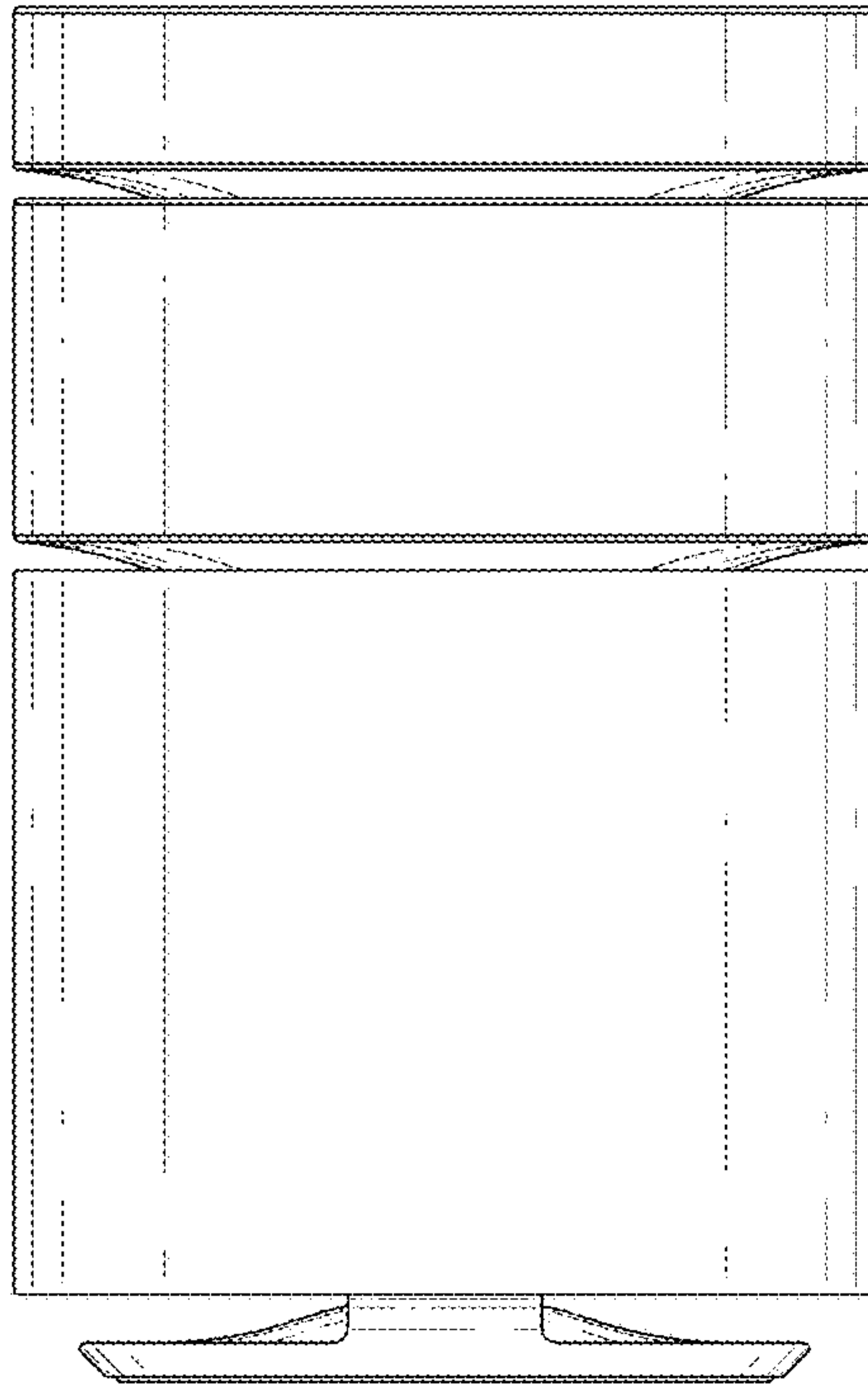

1.5

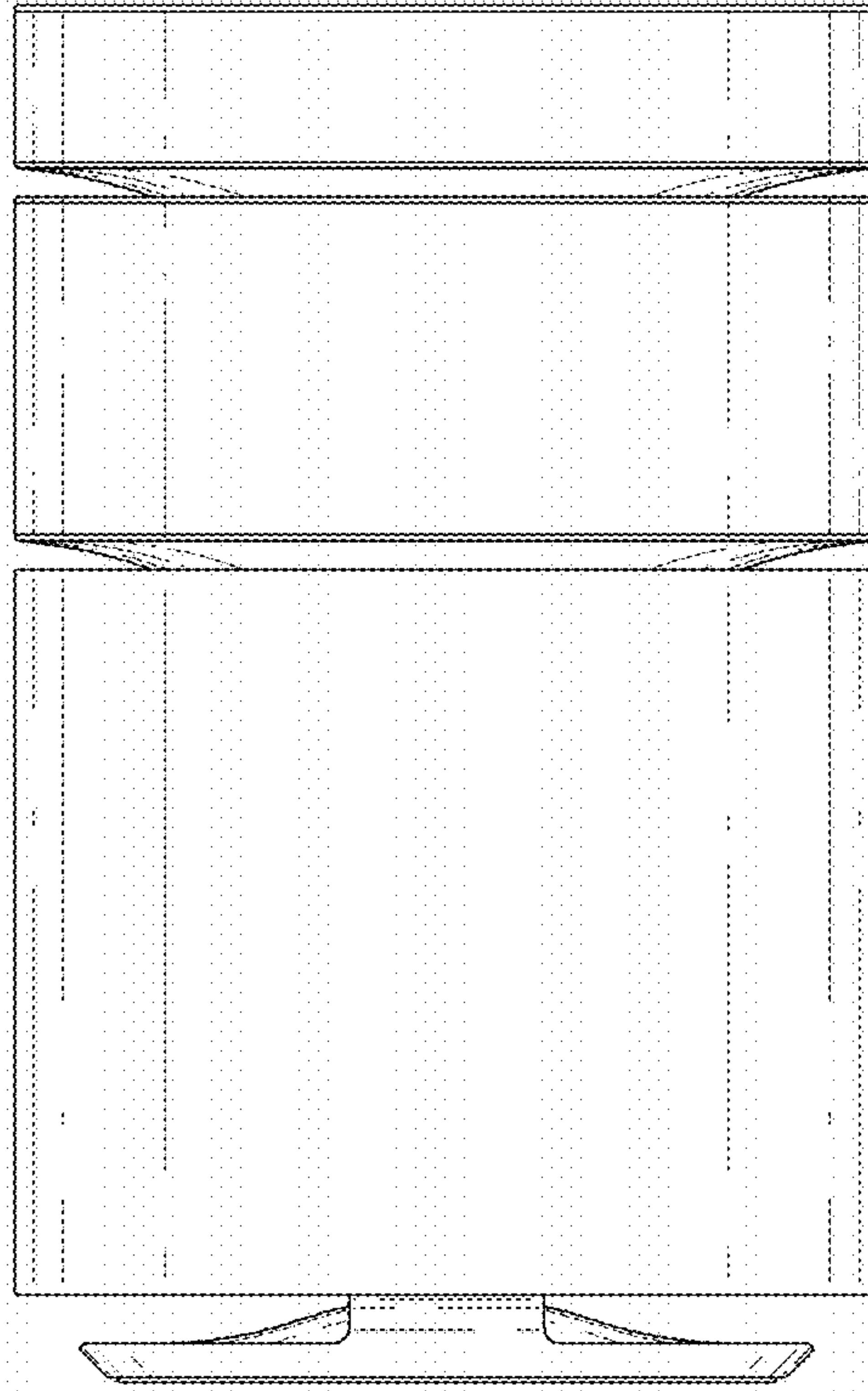

1.6

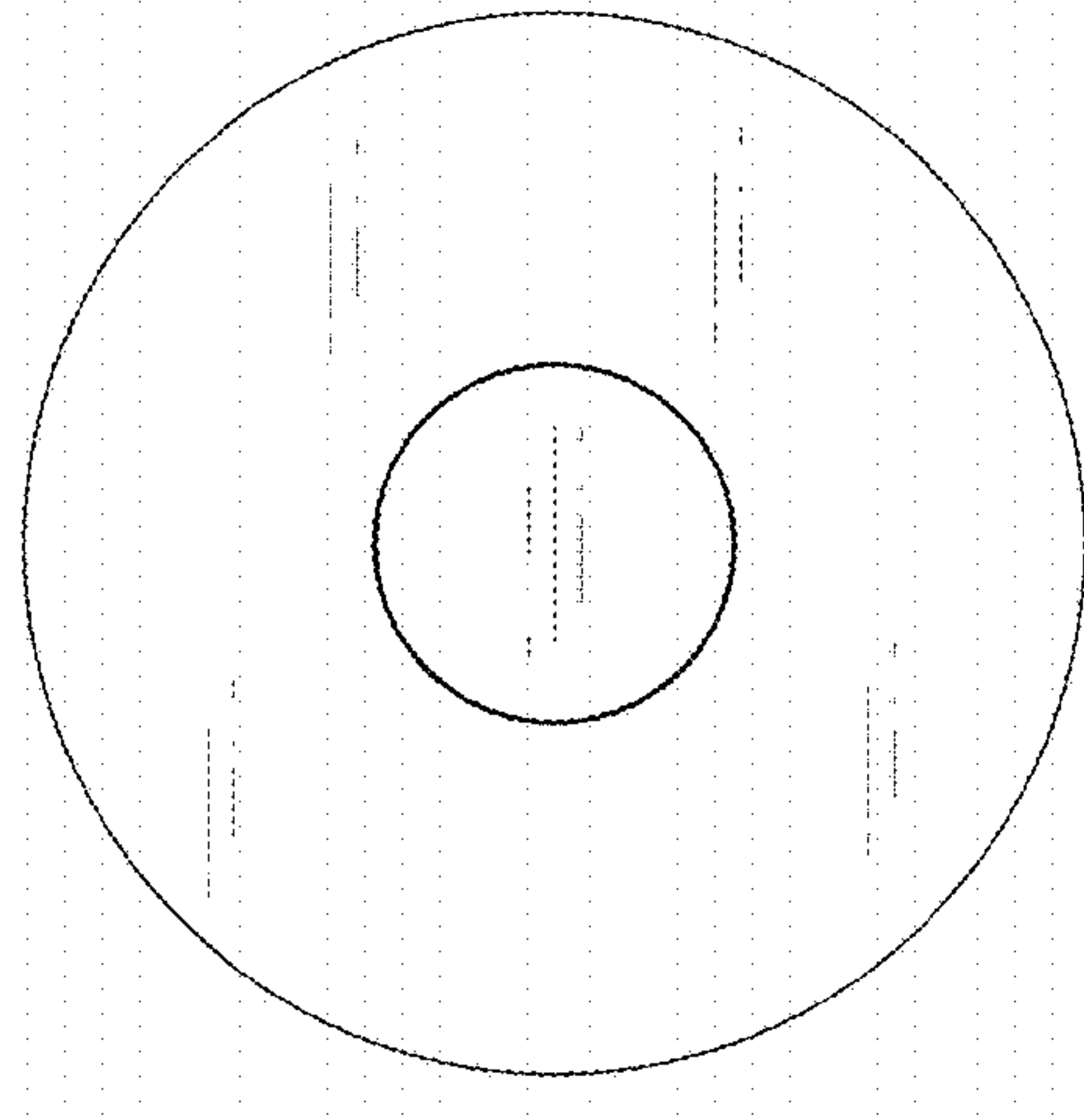

1.7

