

US00D866428S

(12) **United States Design Patent**  
**Papp-Stinson**

(10) **Patent No.:** **US D866,428 S**

(45) **Date of Patent:** **\*\* Nov. 12, 2019**

- (54) **AUTOMOBILE ORNAMENTAL FIGURINE**
- (71) Applicant: **Elizabeth Papp-Stinson**, Port St. Lucie, FL (US)
- (72) Inventor: **Elizabeth Papp-Stinson**, Port St. Lucie, FL (US)
- (\*\*) Term: **15 Years**
- (21) Appl. No.: **29/646,849**
- (22) Filed: **May 8, 2018**
- (51) **LOC (12) Cl.** ..... **12-16**
- (52) **U.S. Cl.**  
USPC ..... **D12/197**
- (58) **Field of Classification Search**  
USPC ..... D12/197-201, 181, 110, 114, 218;  
D11/162, 124, 160, 128  
CPC ..... B60R 13/005  
See application file for complete search history.

- D646,688 S \* 10/2011 Bradford ..... D14/480.2
- D701,443 S \* 3/2014 Weigl, Jr. .... B25G 1/00  
D8/107
- D721,948 S \* 2/2015 Hellkamp ..... D8/395
- D758,201 S \* 6/2016 Sehl ..... D21/599

\* cited by examiner

*Primary Examiner* — Katrina A Betton  
(74) *Attorney, Agent, or Firm* — The Rapacke Law Group, P.A.

(57) **CLAIM**

The ornamental design for an automobile ornamental figurine, as shown and described.

**DESCRIPTION**

FIG. 1 is a perspective view of the automobile ornamental figurine showing the new design;  
FIG. 2 is a front elevational view of the automobile ornamental figurine thereof;  
FIG. 3 is a rear elevational view of the automobile ornamental figurine thereof;  
FIG. 4 is a left side elevational view of the automobile ornamental figurine thereof;  
FIG. 5 is a right side elevational view of the automobile ornamental figurine thereof;  
FIG. 6 is a top plan view of the automobile ornamental figurine thereof; and,  
FIG. 7 is a bottom plan view of the automobile ornamental figurine thereof.

The broken lines in the drawings illustrate environmental subject matter and form no part of the claimed design.

**1 Claim, 6 Drawing Sheets**

(56) **References Cited**

U.S. PATENT DOCUMENTS

- D485,343 S \* 1/2004 Wu ..... D23/367
- D493,909 S \* 8/2004 Sehl ..... D26/98
- D507,988 S \* 8/2005 Latone ..... D11/100
- D517,187 S \* 3/2006 Wu ..... D21/597
- D517,881 S \* 3/2006 Kelleghan ..... D8/38
- D518,752 S \* 4/2006 Udco ..... D11/82
- D525,065 S \* 7/2006 Coppola ..... D6/601
- D582,591 S \* 12/2008 van der Lande ..... D26/47
- D620,676 S \* 8/2010 Haro ..... D1/111

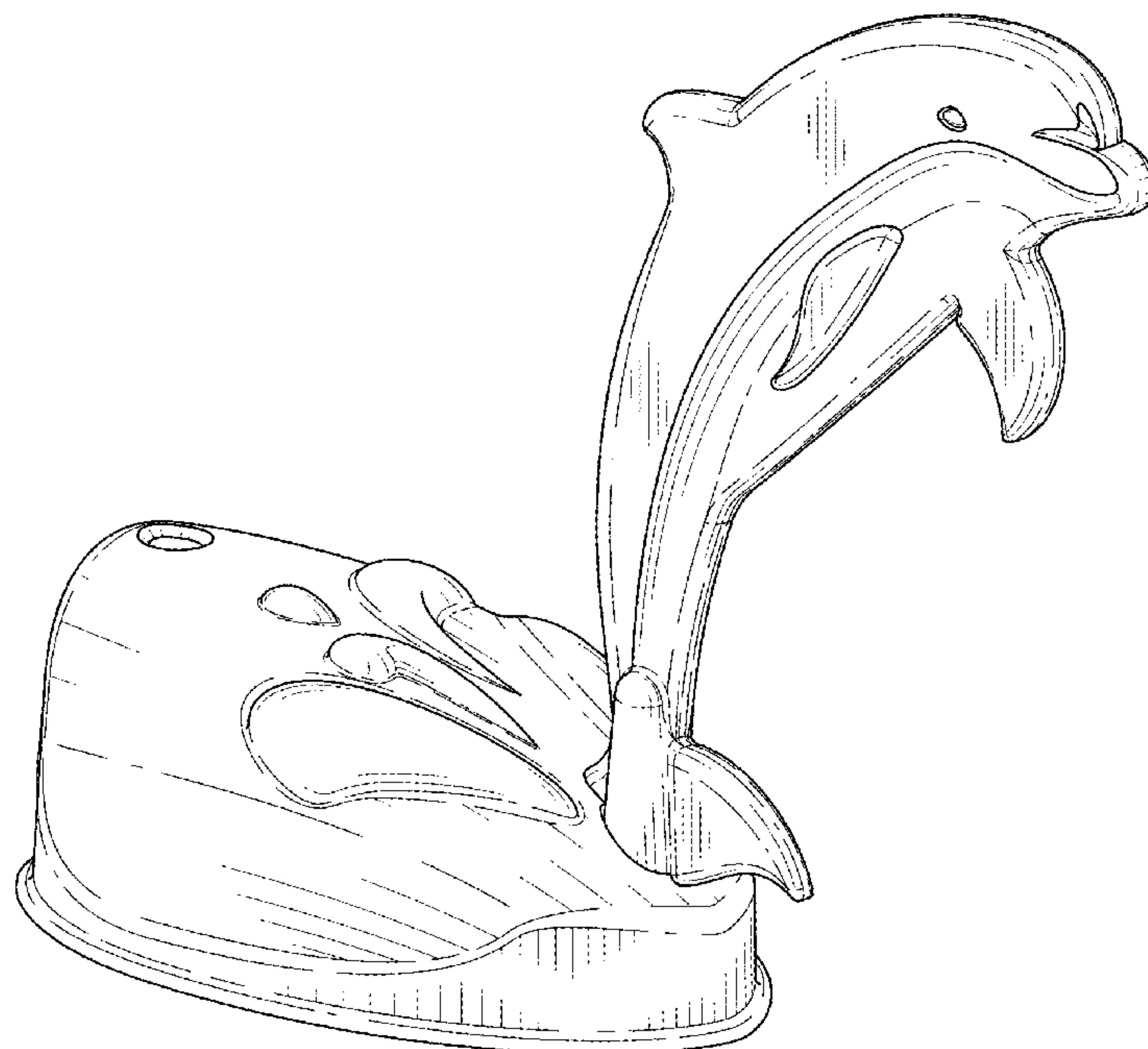

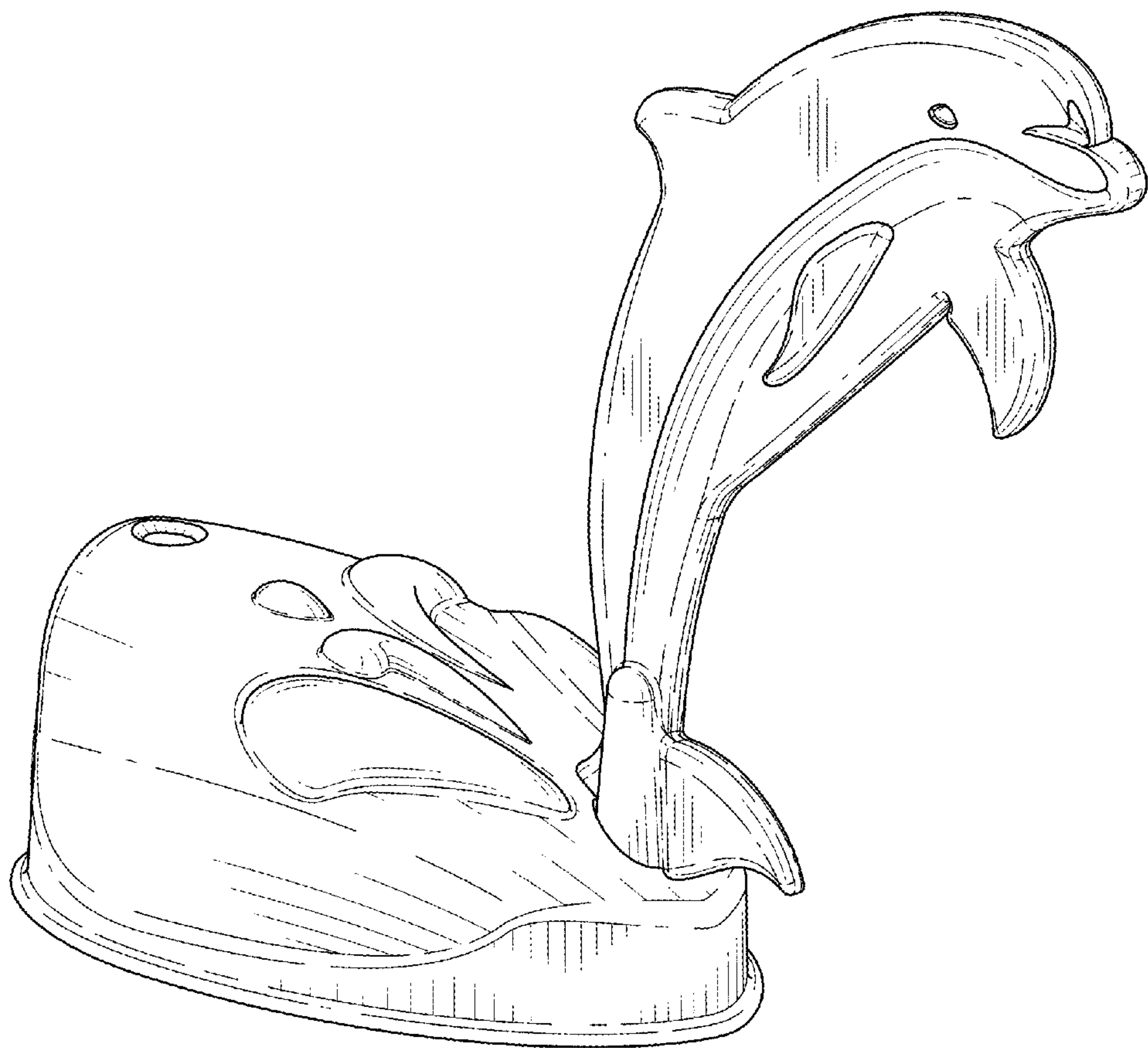

*FIG. 1*

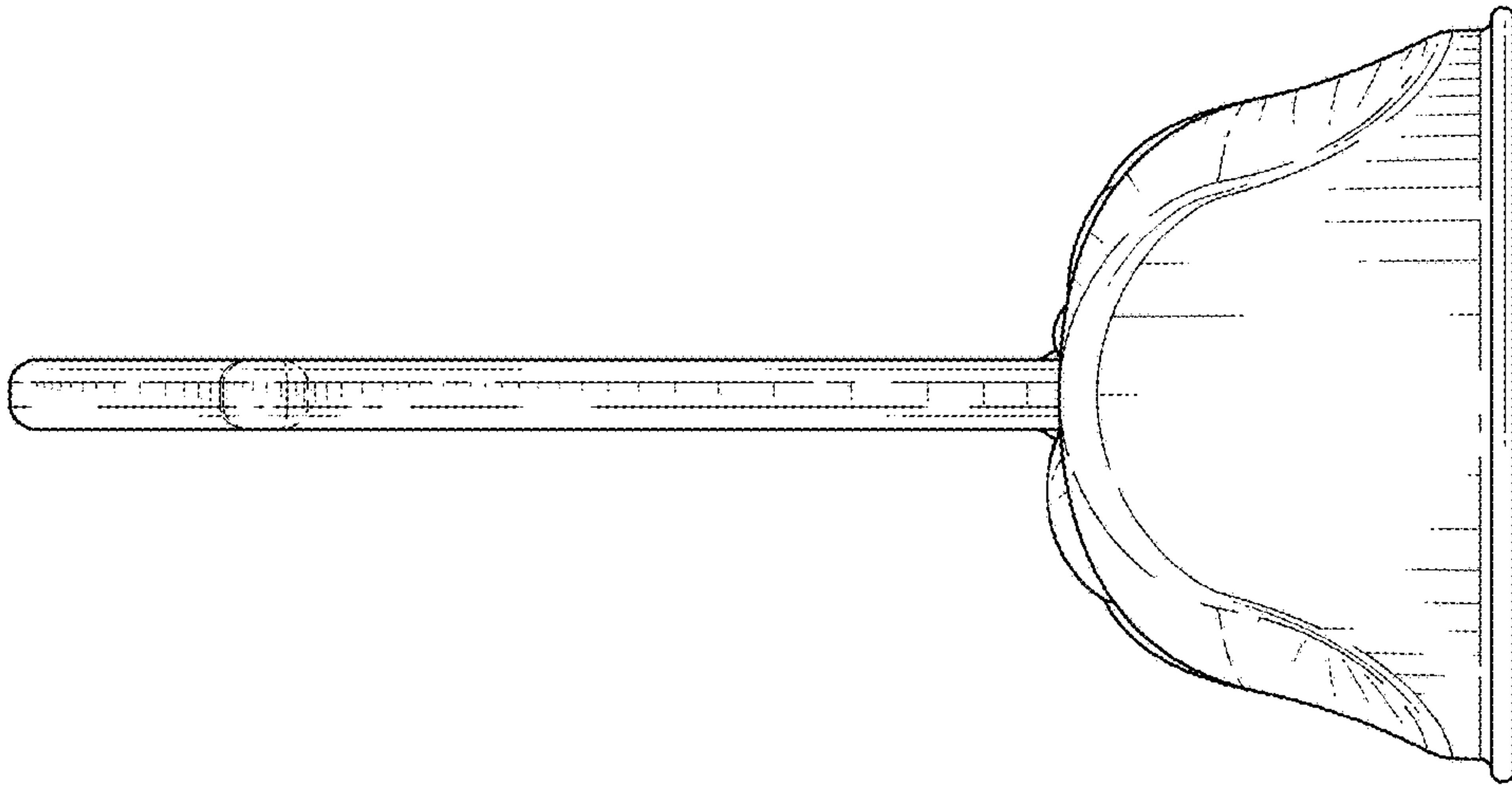

FIG. 3

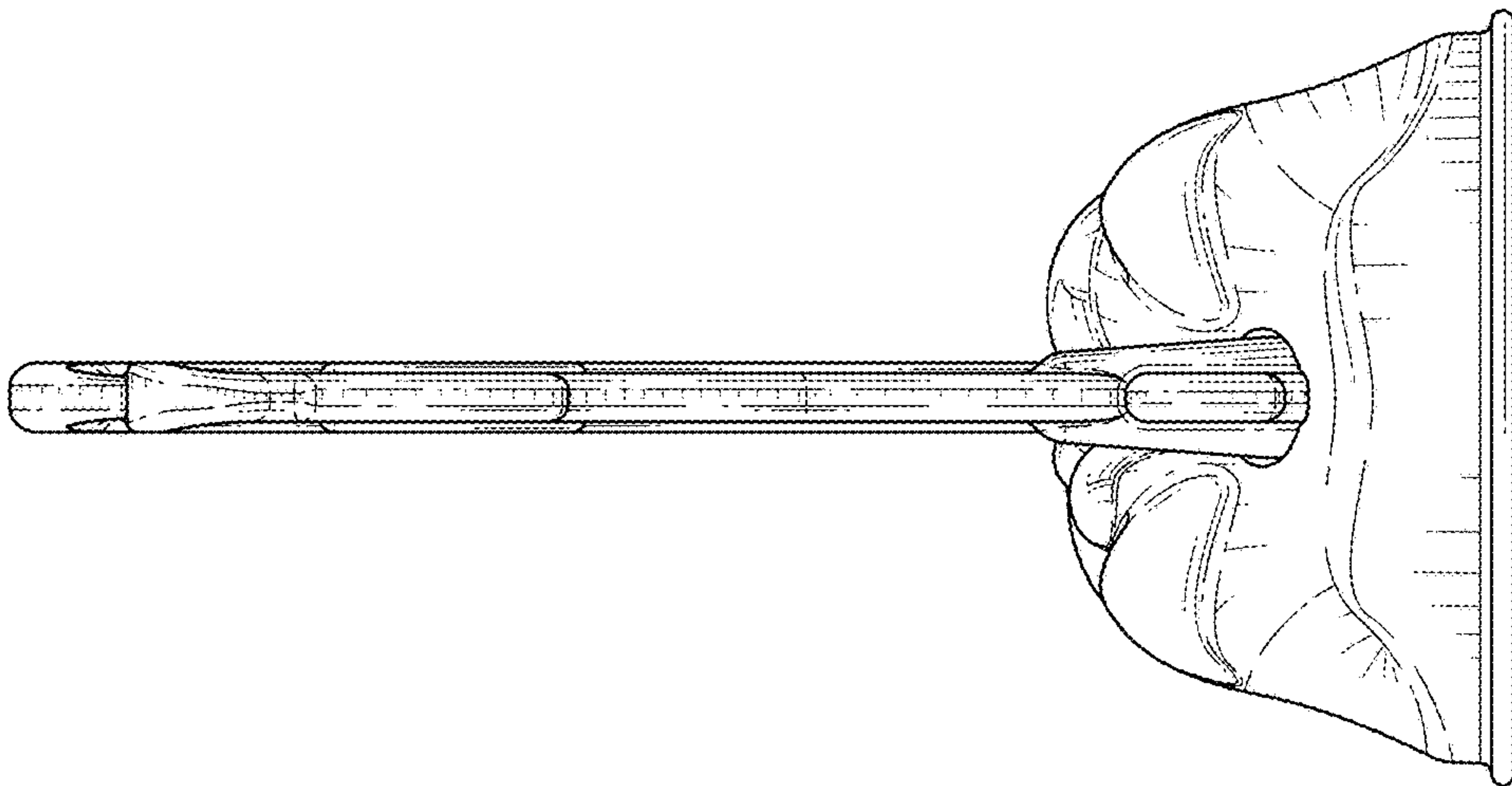

FIG. 2

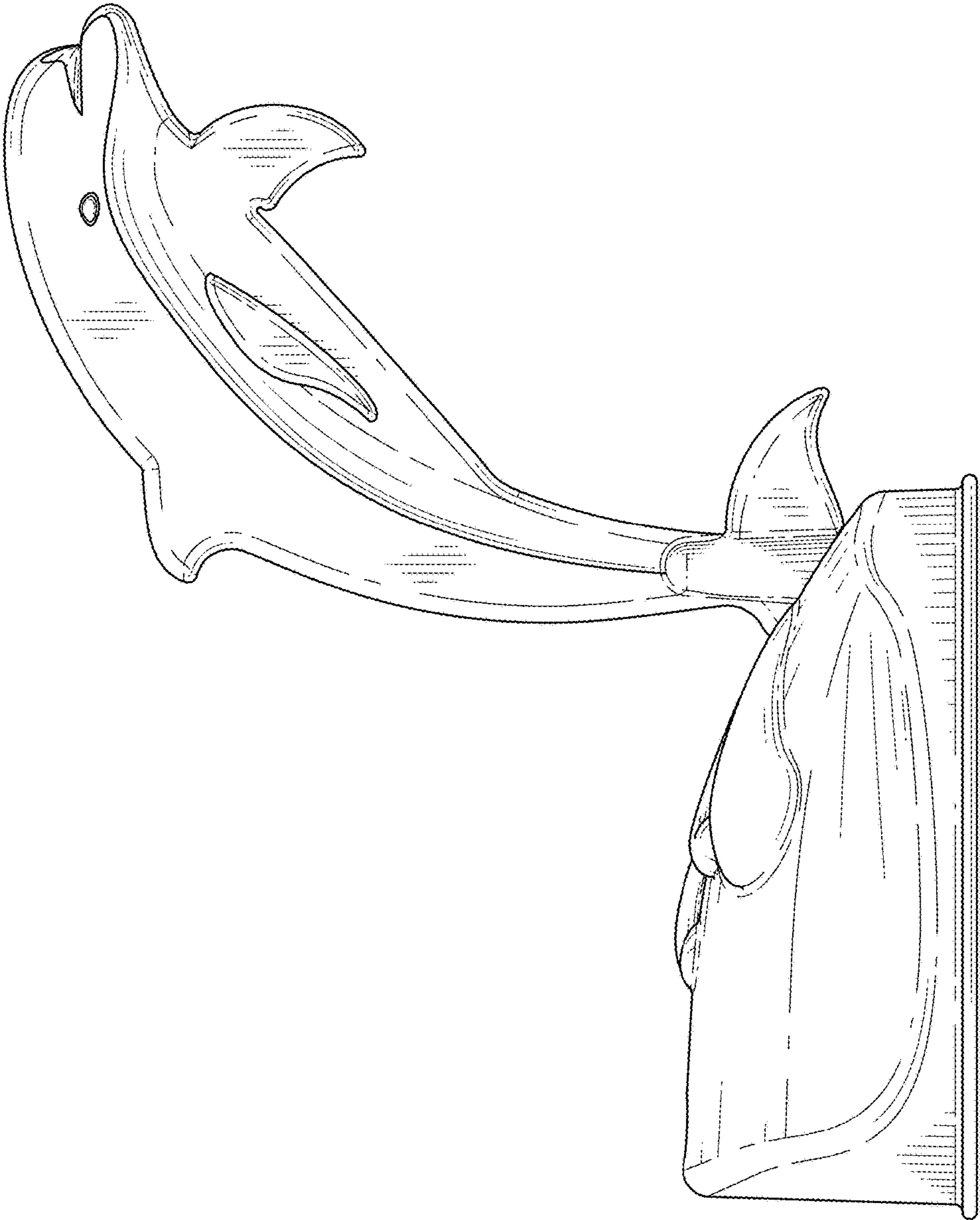

FIG. 4

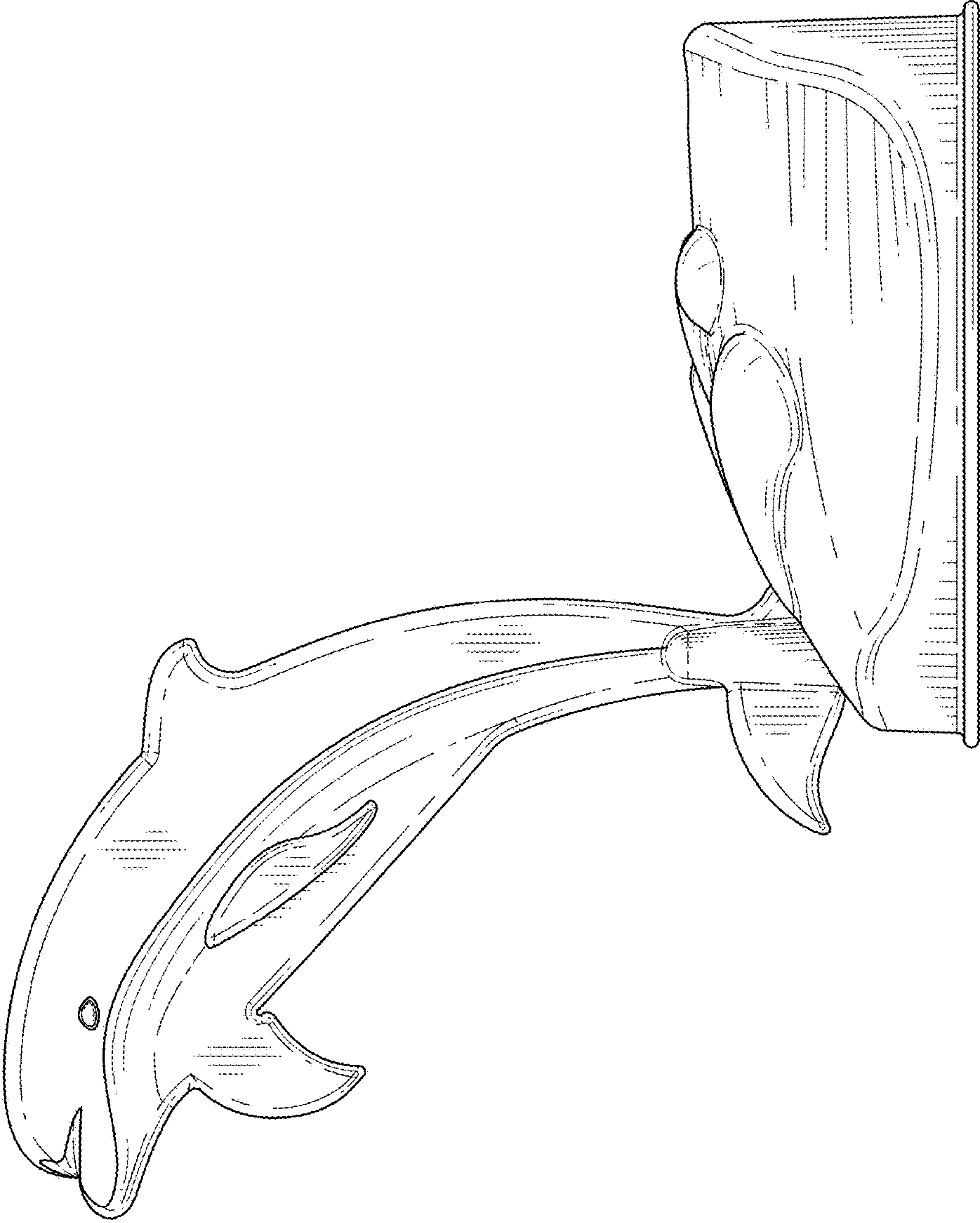
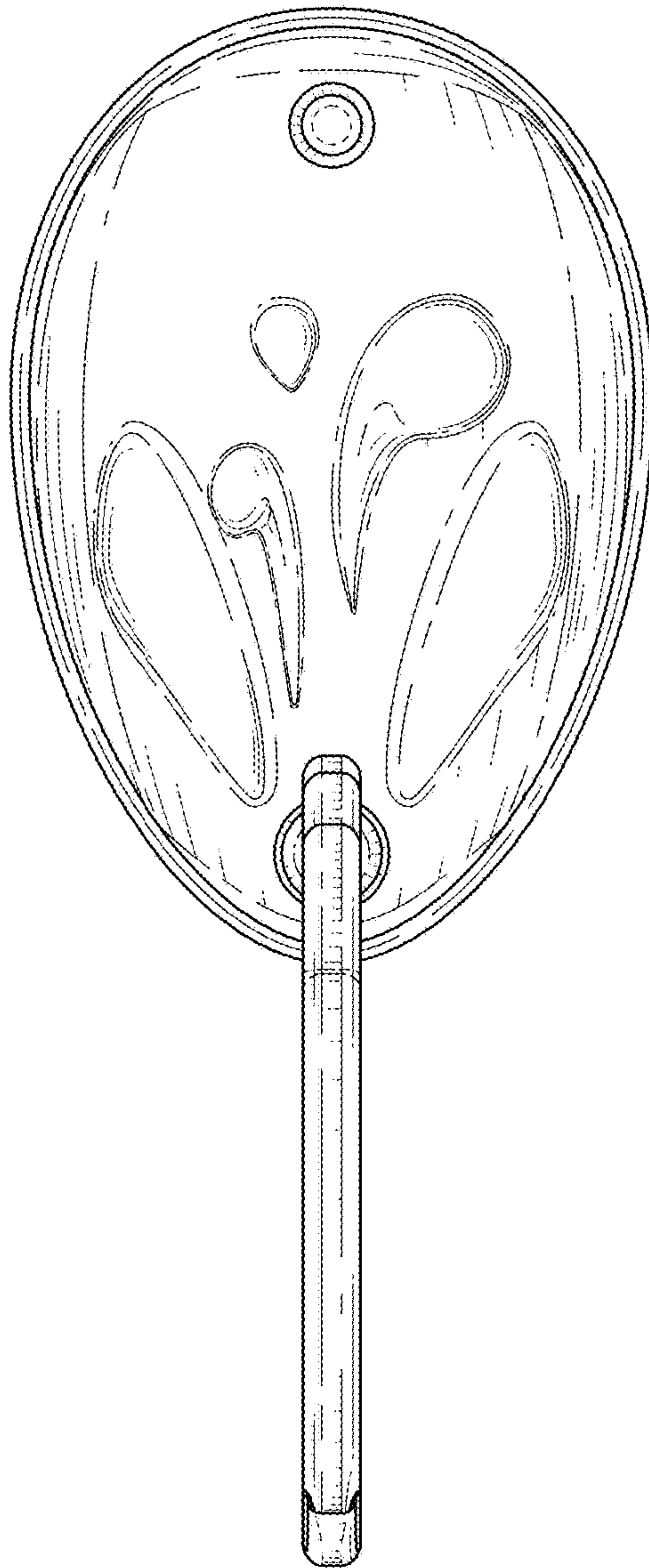
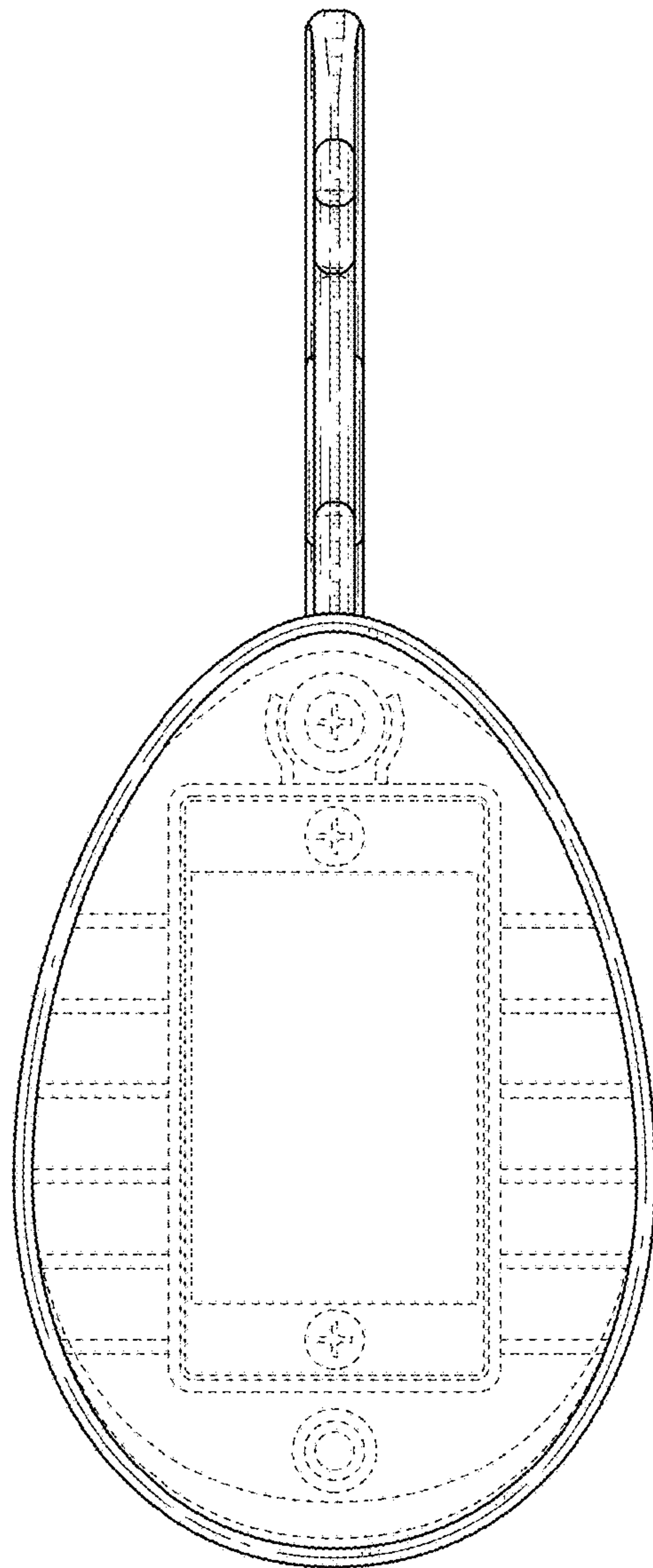

FIG. 5





**FIG. 6**



**FIG. 7**