



US00D866425S

(12) **United States Design Patent** (10) **Patent No.:** **US D866,425 S**
Lee (45) **Date of Patent:** **** Nov. 12, 2019**

(54) **EXHAUST GAS DISCHARGE INDUCING APPARATUS FOR VEHICLE**

(71) Applicant: **Bum Hyung Lee**, Seoul (KR)

(72) Inventor: **Bum Hyung Lee**, Seoul (KR)

(**) Term: **15 Years**

(21) Appl. No.: **29/605,687**

(22) Filed: **May 30, 2017**

(30) **Foreign Application Priority Data**

Dec. 1, 2016 (KR) 30-2016-0058056

(51) **LOC (12) Cl.** **12-16**

(52) **U.S. Cl.**
USPC **D12/194**

(58) **Field of Classification Search**
USPC D13/123; D15/5, 148, 149; D12/174,
D12/177, 194, 206, 213, 216, 400
CPC F01N 3/2892; F15D 1/08
See application file for complete search history.

(56) **References Cited**

U.S. PATENT DOCUMENTS

D593,014 S *	5/2009	Marovič	D12/194
7,963,265 B2 *	6/2011	Tassinari	F02M 35/10019 123/184.56
D642,199 S *	7/2011	Luxon	D12/400
D648,745 S *	11/2011	Luxon	D12/400
D704,745 S *	5/2014	Richard	D15/5
D704,746 S *	5/2014	Richard	D15/5
D704,747 S *	5/2014	Richard	D15/5
D705,270 S *	5/2014	Richard	D15/5

D707,601 S *	6/2014	Chou	D12/194
D707,602 S *	6/2014	Chou	D12/194
D707,603 S *	6/2014	Chou	D12/194
D707,604 S *	6/2014	Chou	D12/194
D708,102 S *	7/2014	Chou	D12/194
D734,699 S *	7/2015	Fox	D12/194
D775,036 S *	12/2016	Shafer	D12/194
D775,565 S *	1/2017	Shafer	D12/194
9,683,527 B2 *	6/2017	Tallman	F02M 35/10013
D802,507 S *	11/2017	Ochoa	D12/194
D808,587 S *	1/2018	Carello	D28/18
D832,755 S *	11/2018	Nagano	D12/194
D832,756 S *	11/2018	Akrapovic	D12/194
D837,706 S *	1/2019	Hara	D12/194
2009/0118121 A1 *	5/2009	Sarai	B01D 46/0024 502/439

* cited by examiner

Primary Examiner — Garth Rademaker

Assistant Examiner — Fritzgerald L Butac

(74) *Attorney, Agent, or Firm* — Kusner & Jaffe

(57) **CLAIM**

The ornamental design for an exhaust gas discharge inducing apparatus for vehicle, as shown and described.

DESCRIPTION

FIG. 1 is a perspective view of an exhaust gas discharge inducing apparatus for vehicle, showing my new design;

FIG. 2 is a front view thereof;

FIG. 3 is a back view thereof;

FIG. 4 is a left view thereof;

FIG. 5 is a right view thereof;

FIG. 6 is a top view thereof; and,

FIG. 7 is a bottom view thereof.

1 Claim, 7 Drawing Sheets

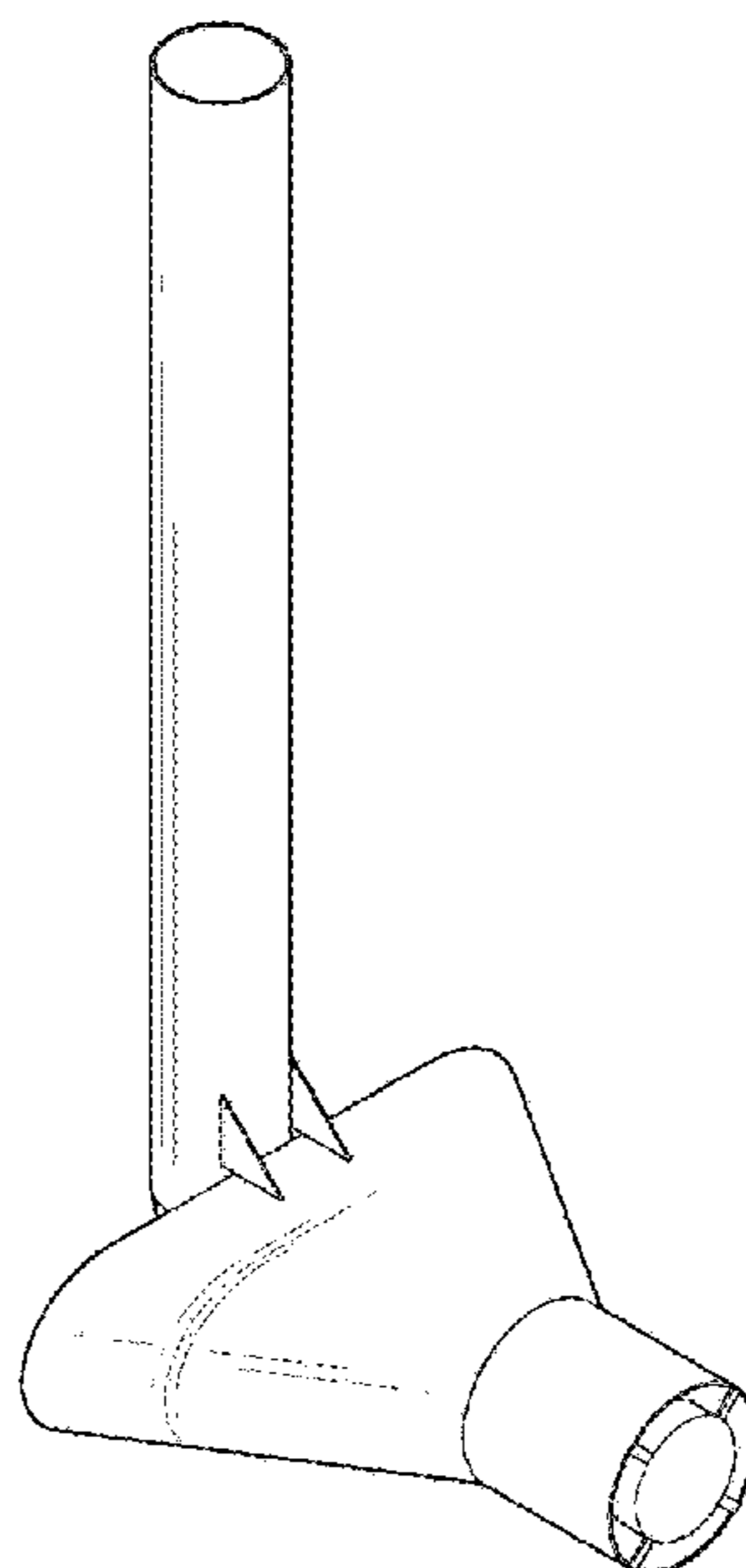

FIG. 1

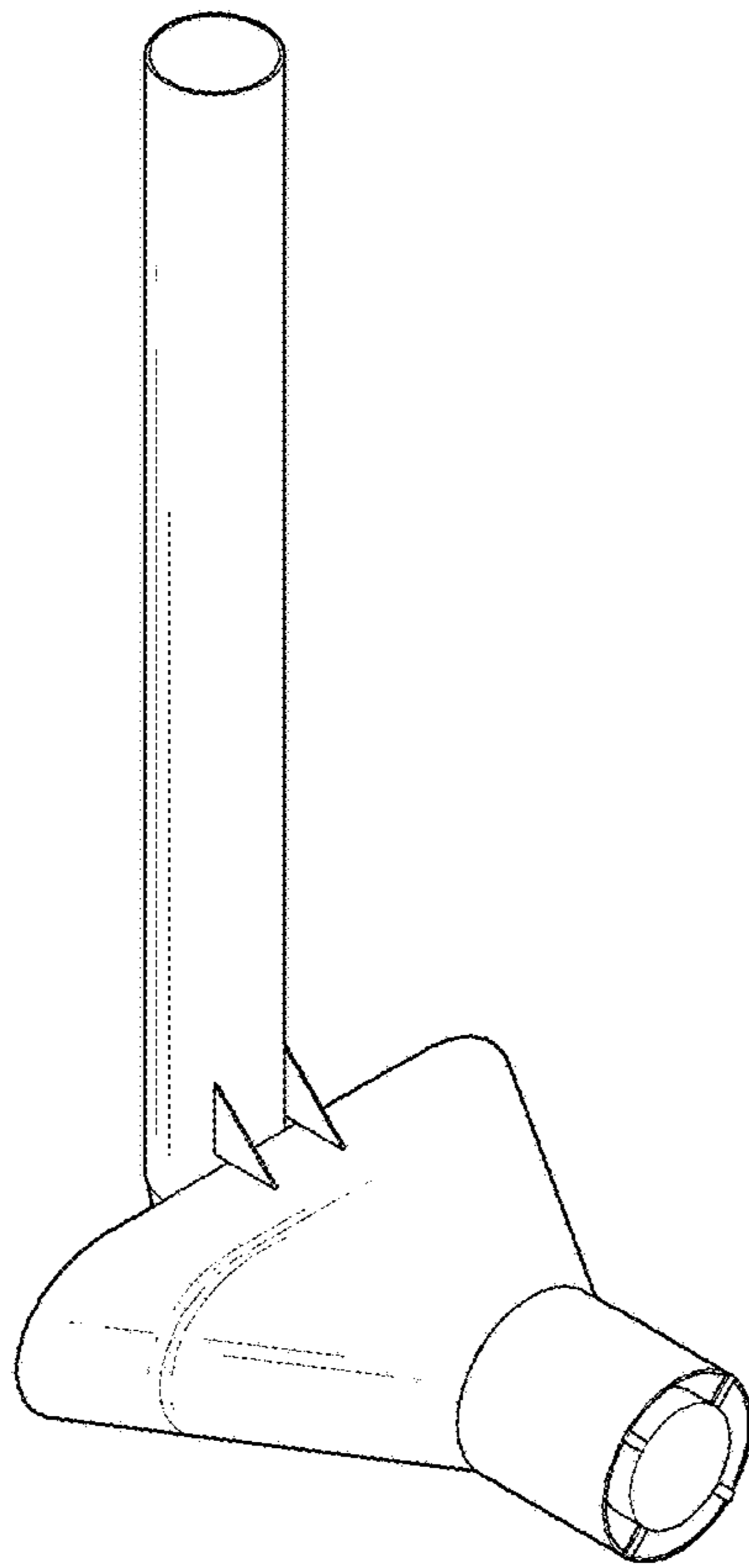

FIG. 2

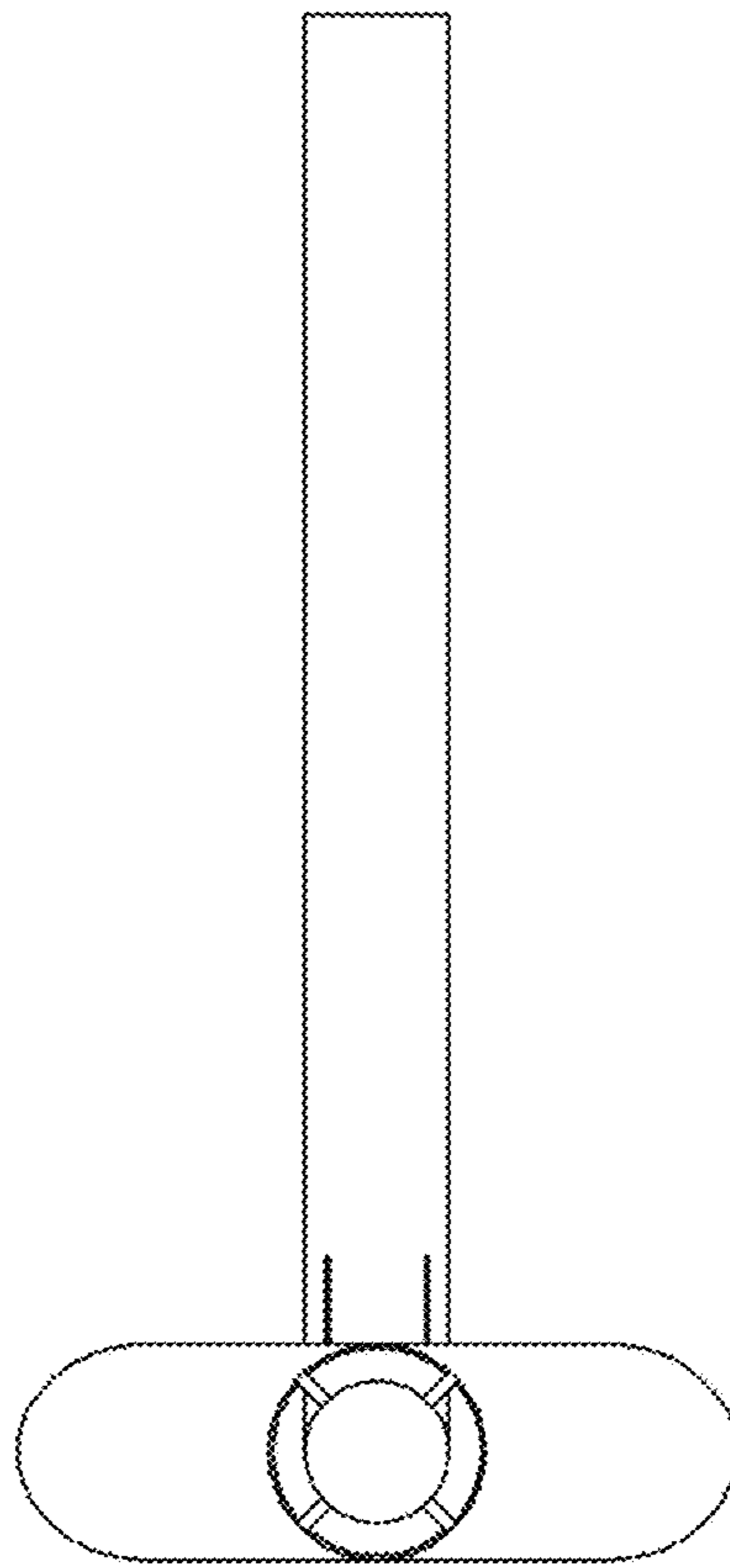

FIG. 3

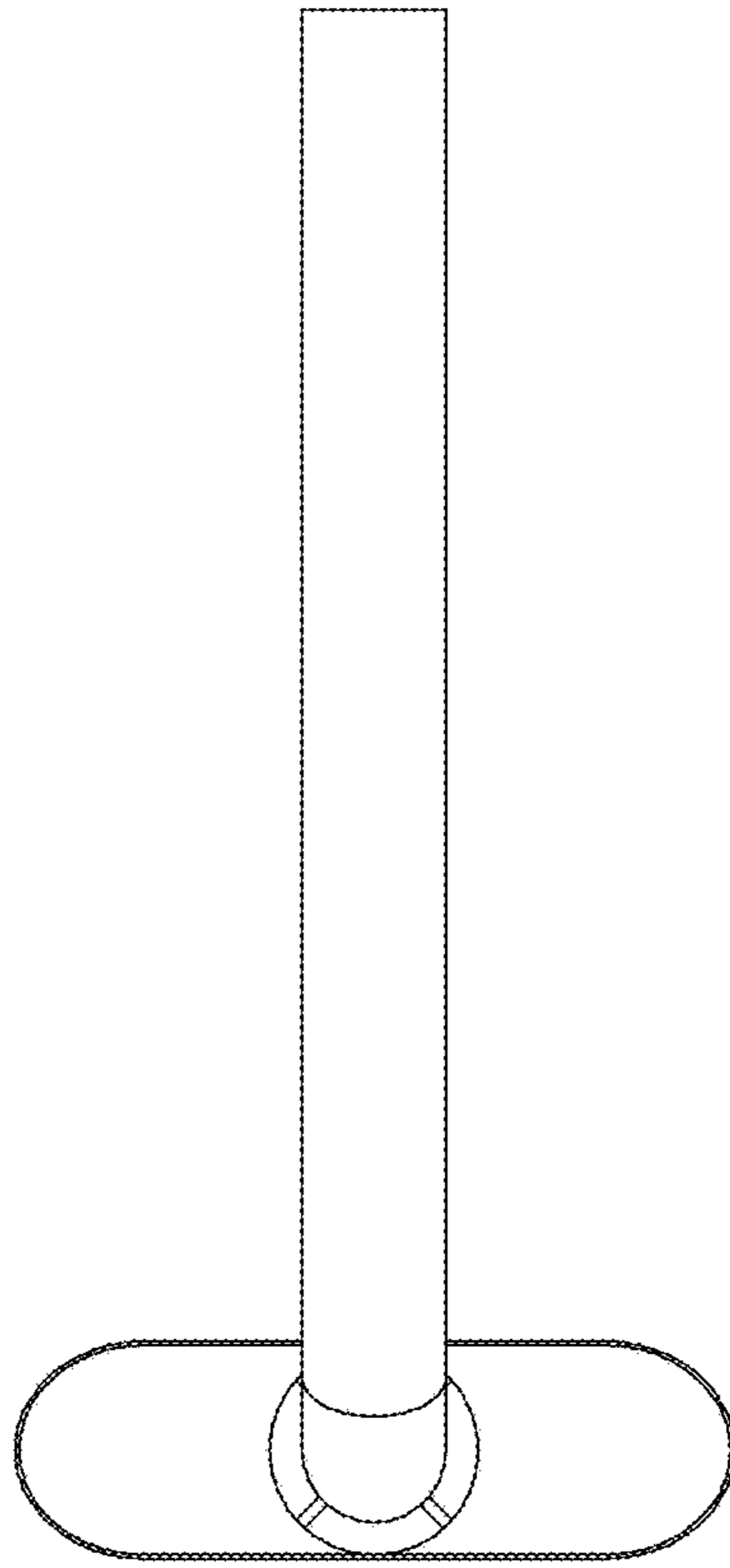

FIG. 4

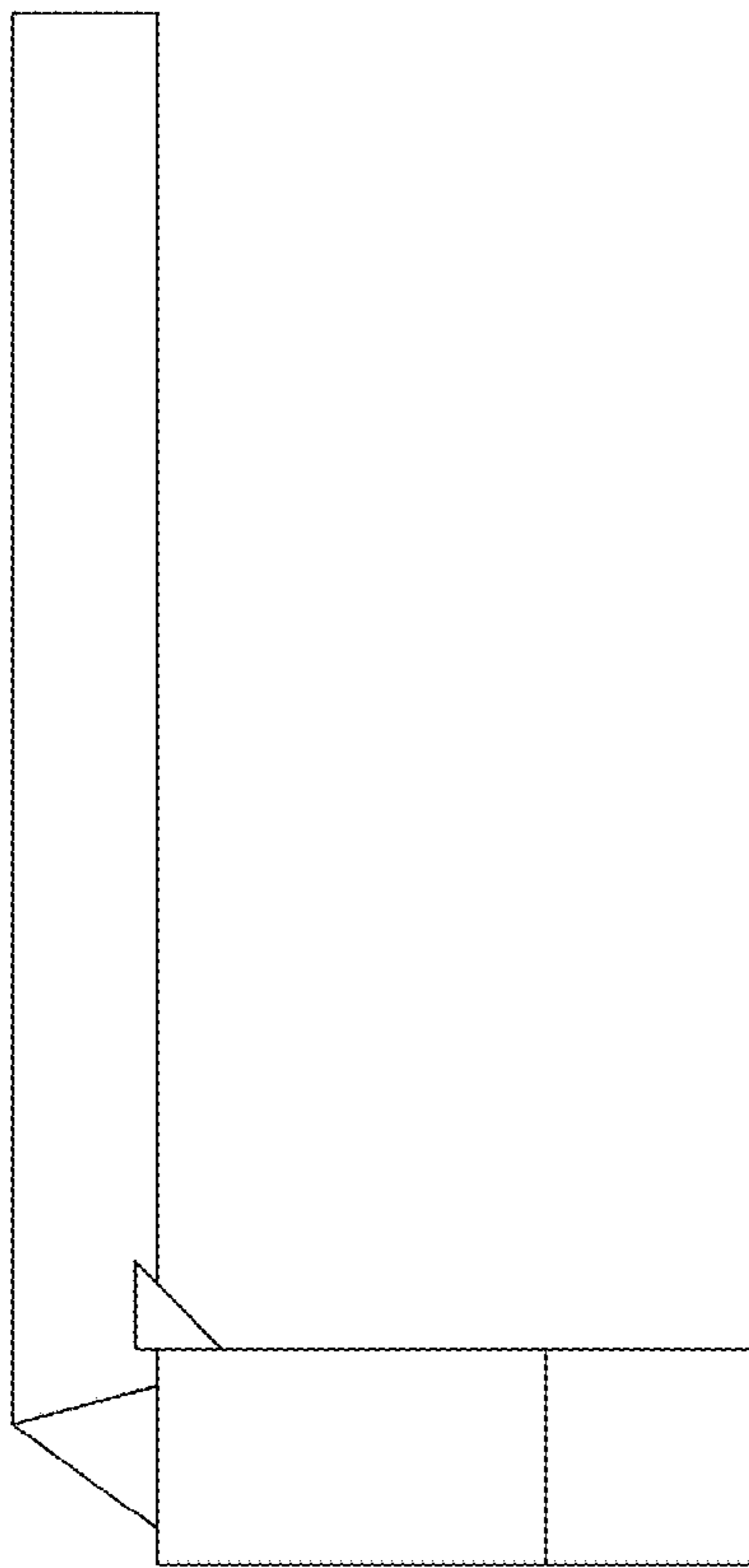

FIG. 5

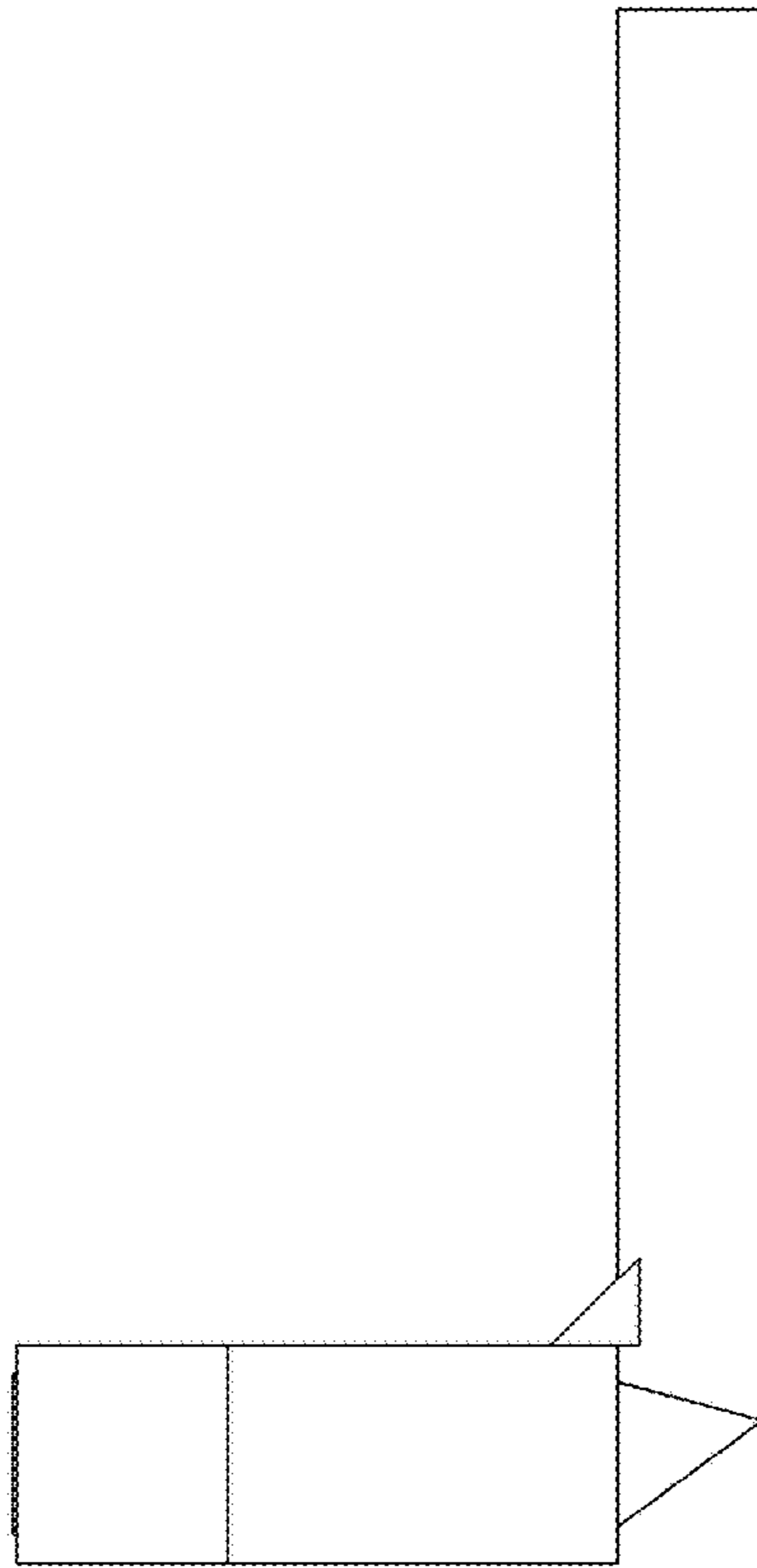

FIG. 6

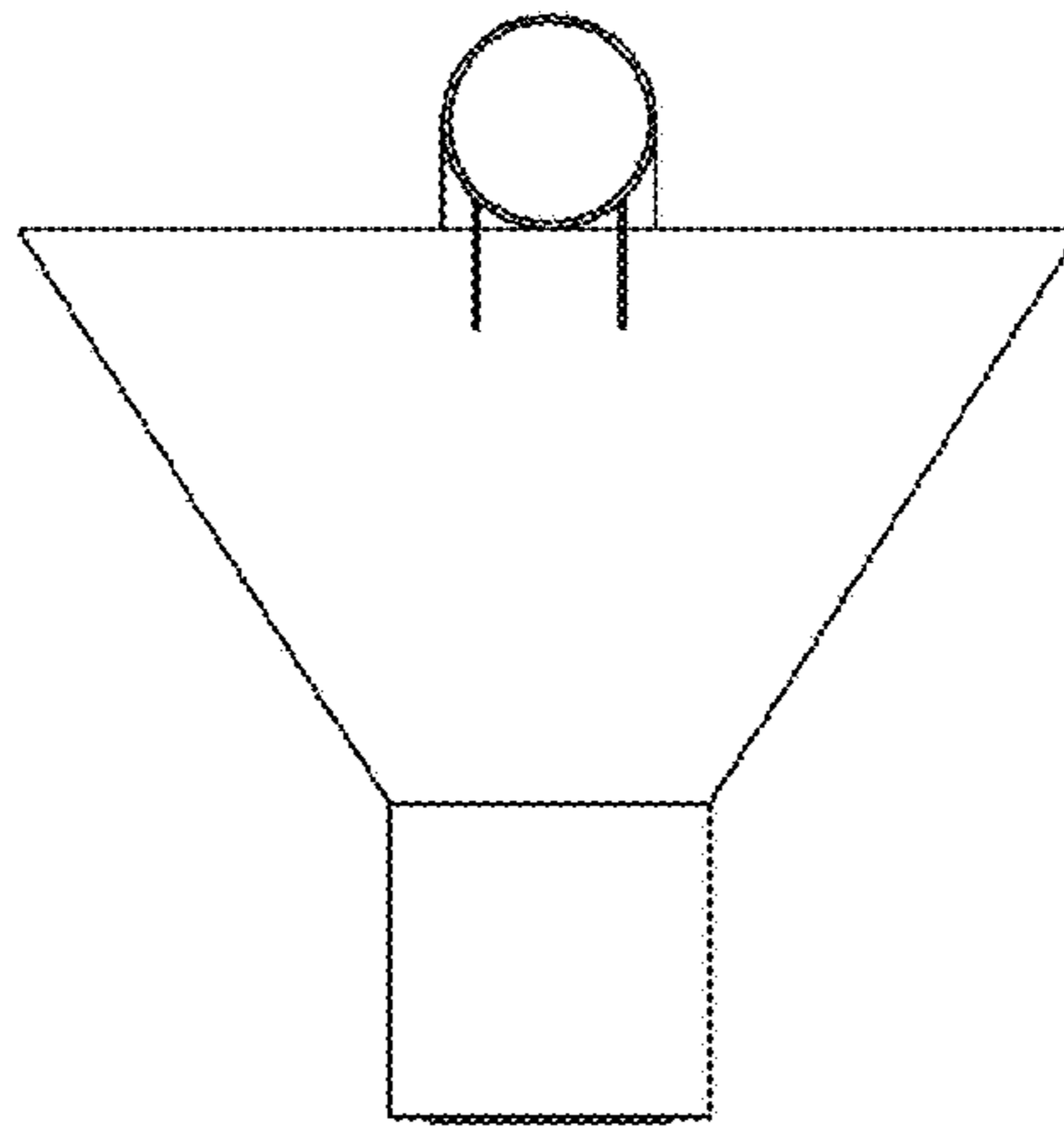

FIG. 7

