



US00D866379S

(12) **United States Design Patent** (10) **Patent No.:** **US D866,379 S**
Siminoff et al. (45) **Date of Patent:** **** *Nov. 12, 2019**

(54) **WIRELESS ENTRANCE COMMUNICATION DEVICE**

FOREIGN PATENT DOCUMENTS

(71) Applicant: **Amazon Technologies, Inc.**, Seattle, WA (US)

CN 3081868D 7/1998
CN 300801060D 7/2008

(Continued)

(72) Inventors: **Mark Siminoff**, Mountain View, CA (US); **James Siminoff**, Pacific Palisades, CA (US); **Spiro Sacre**, Los Angeles, CA (US); **John Modestine**, Los Angeles, CA (US); **Elliott Lemberger**, Santa Monica, CA (US)

OTHER PUBLICATIONS

Amazon, "Ring Video Doorbell 2", retrieved at www.Amazon.com; Mar. 15, 2018; 10 pages.

(Continued)

(73) Assignee: **Amazon Technologies, Inc.**, Seattle, WA (US)

Primary Examiner — George D. Kirschbaum

Assistant Examiner — Joseph J Kukella

(74) *Attorney, Agent, or Firm* — Lee & Hayes, P.C.

(*) Notice: This patent is subject to a terminal disclaimer.

(**) Term: **15 Years**

(57) **CLAIM**

(21) Appl. No.: **29/654,872**

The ornamental design for a wireless entrance communication device, as shown and described.

(22) Filed: **Jun. 28, 2018**

Related U.S. Application Data

DESCRIPTION

(63) Continuation of application No. 29/637,291, filed on Feb. 15, 2018, now Pat. No. Des. 822,519, which is (Continued)

(51) **LOC (12) Cl.** **10-05**

(52) **U.S. Cl.**
USPC **D10/118.2**

(58) **Field of Classification Search**
USPC D10/104.1, 108, 116.1, 118, 118.2,
D10/121-126; D16/202, 203, 208, 209,
D16/215

(Continued)

(56) **References Cited**

U.S. PATENT DOCUMENTS

D181,376 S 11/1957 Smith
D197,278 S * 1/1964 Stevenson D13/171

(Continued)

FIG. 1 is a front perspective view of a preferred embodiment of the wireless entrance communication device according to the present design;
FIG. 2 is a front elevational view of the wireless entrance communication device of FIG. 1;
FIG. 3 is a rear elevational view of the wireless entrance communication device of FIG. 1;
FIG. 4 is a right-side elevational view of the wireless entrance communication device of FIG. 1, the left-side elevational view being a mirror image thereof;
FIG. 5 is a top plan view of the wireless entrance communication device of FIG. 1; and,
FIG. 6 is a bottom plan view of the wireless entrance communication device of FIG. 1.
In the drawings, dashed lines depict environmental subject matter only and form no part of the claimed design.

1 Claim, 5 Drawing Sheets

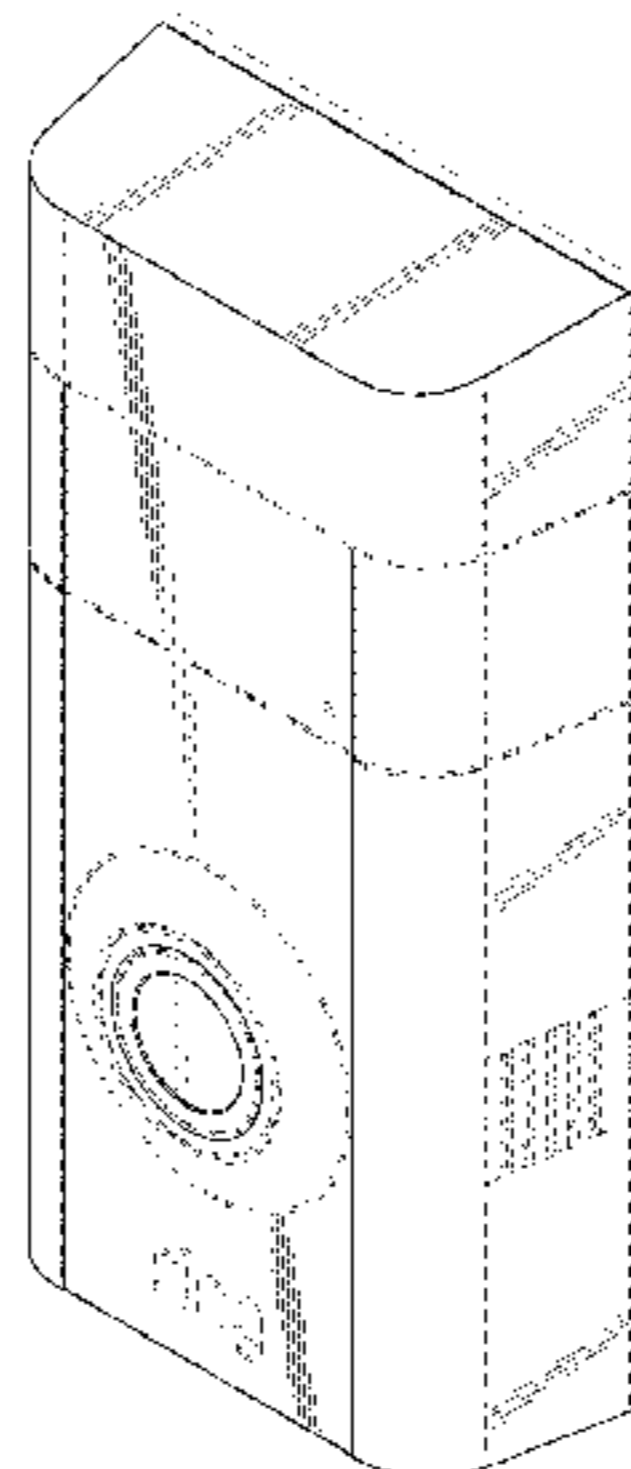

Related U.S. Application Data

a continuation of application No. 29/595,337, filed on Feb. 27, 2017, now Pat. No. Des. 830,871.

- (58) **Field of Classification Search**
 CPC ... G08B 3/00; G08B 3/10; G08B 7/00; G08B 7/06
 See application file for complete search history.

References Cited

U.S. PATENT DOCUMENTS

D258,424	S	3/1981	Doggart	
D392,576	S	3/1998	Pun	
D500,751	S	1/2005	Yukikado et al.	
D562,306	S	2/2008	Jeong et al.	
D573,500	S	7/2008	Beland et al.	
D574,742	S	8/2008	Spencer	
D591,321	S	4/2009	Sheppard et al.	
D605,542	S	12/2009	Ho	
D609,727	S	2/2010	Adolfsson et al.	
D610,031	S	2/2010	Beland et al.	
D612,882	S	3/2010	Kim et al.	
D621,795	S	8/2010	Tsui et al.	
D633,930	S	3/2011	Dinger et al.	
D635,102	S	3/2011	Tsui et al.	
D636,286	S	4/2011	Khor et al.	
D636,287	S	4/2011	Khor et al.	
D636,424	S	4/2011	Lin	
D637,099	S	5/2011	Khor et al.	
D641,771	S	7/2011	Sasaki et al.	
D666,656	S	9/2012	Furlan et al.	
D666,657	S	9/2012	Furlan et al.	
D666,658	S	9/2012	Furlan et al.	
D666,659	S	9/2012	Furlan et al.	
D698,841	S	2/2014	Lee et al.	
D707,147	S	6/2014	Crippa et al.	
D710,727	S	8/2014	Siminoff	
D710,728	S	8/2014	Siminoff	
D721,113	S	1/2015	Huang	
D736,845	S	8/2015	Yilin	
D749,006	S	2/2016	Ure et al.	
D752,011	S	3/2016	Takahata	
D754,231	S	4/2016	Murray	
D761,753	S	7/2016	Michielan	
D764,958	S	8/2016	Scalisi	
D765,530	S	9/2016	Scalisi	
D766,865	S	9/2016	Tani	
D773,428	S	12/2016	Takahata	
D774,875	S	12/2016	Yu	
D778,195	S	2/2017	Li	
9,584,775	B2	2/2017	Siminoff et al.	
D782,282	S	3/2017	Huang et al.	
D787,359	S	5/2017	Scalisi	
D788,061	S	5/2017	Siminoff	
D789,820	S	6/2017	Siminoff et al.	
D792,192	S	7/2017	Huang et al.	
D793,268	S	8/2017	Ye	
D794,487	S	8/2017	Chui et al.	
D795,833	S	8/2017	Zhou	
D798,177	S	9/2017	Siminoff et al.	
D801,843	S	11/2017	Siminoff	
D802,463	S	11/2017	Siminoff et al.	
9,819,713	B2	11/2017	Siminoff et al.	
D806,773	S	1/2018	Wiser et al.	
D817,208	S *	5/2018	Ravat D10/118.2	
D819,476	S *	6/2018	Siminoff D10/118.2	
D820,137	S *	6/2018	Siminoff D10/118.2	
D820,708	S *	6/2018	Siminoff D10/118.2	
D822,518	S *	7/2018	Siminoff D10/118.2	
D822,519	S *	7/2018	Siminoff D10/118.2	
D822,520	S *	7/2018	Siminoff D10/118.2	
D829,585	S *	10/2018	Siminoff D10/118.2	
D830,871	S *	10/2018	Siminoff D10/118.2	
D833,313	S *	11/2018	Siminoff D10/118.2	
D837,080	S *	1/2019	Siminoff D10/118.2	
2004/0124978	A1	7/2004	Chen	

2016/0330403	A1	11/2016	Siminoff	
2017/0160137	A1	6/2017	Jeong	
2017/0160138	A1	6/2017	Jeong et al.	
2017/0163944	A1	6/2017	Jeong	
2017/0171516	A1	6/2017	Modestine	
2017/0171517	A1	6/2017	Modestine et al.	
2017/0171518	A1	6/2017	Modestine et al.	
2017/0195639	A1	7/2017	Gluckman et al.	
2017/0251035	A1	8/2017	Siminoff et al.	
2017/0251173	A1	8/2017	Siminoff et al.	
2017/0251182	A1	8/2017	Siminoff et al.	
2017/0272269	A1	9/2017	Siminoff	
2017/0272652	A1	9/2017	Siminoff et al.	
2017/0272706	A1	9/2017	Jeong	
2017/0280112	A1	9/2017	Siminoff	
2017/0289450	A1	10/2017	Lemberger	
2017/0294694	A1	10/2017	Tso et al.	
2017/0322942	A1	11/2017	Duda et al.	
2017/0323591	A1	11/2017	Siminoff et al.	
2017/0358186	A1	12/2017	Harpole	

FOREIGN PATENT DOCUMENTS

CN	300955818D	7/2009	
CN	300974854D	8/2009	
CN	301122354D	1/2010	
CN	301478976 S	3/2011	
CN	301551981 S	5/2011	
CN	301611656 S	7/2011	
CN	301633680 S	8/2011	
CN	301665587 S	9/2011	
CN	301678882 S	9/2011	
CN	301853516 S	3/2012	
CN	301860768 S	3/2012	
CN	301895157 S	4/2012	
CN	301923959 S	5/2012	
CN	302143296 S	10/2012	
CN	302202377 S	11/2012	
CN	302294861 S	1/2013	
CN	302445674 S	5/2013	
CN	302534164 S	8/2013	
CN	302670380 S	12/2013	
CN	302803522 S	4/2014	
CN	303042049 S	4/2014	
CN	302888886 S	7/2014	
CN	302895510 S	7/2014	
CN	302993301 S	11/2014	
CN	303011099 S	11/2014	
CN	303032510 S	12/2014	
CN	303095909 S	2/2015	
CN	303106808 S	2/2015	
CN	303127089 S	3/2015	
CN	303309010 S	7/2015	
CN	303415611 S	10/2015	
CN	303571661 S	1/2016	
CN	303603948 S	3/2016	
CN	30301786 S	6/2016	
CN	303699968 S	6/2016	
CN	303770686	8/2016	
CN	303803938 S	8/2016	
CN	304045010 S	8/2016	
CN	303838893 S	9/2016	
CN	303870855 S	9/2016	
CN	303911541 S	11/2016	
CN	303947146 S	11/2016	
CN	303958058 S	12/2016	
CN	303977113 S	12/2016	
CN	304005502 S	1/2017	
CN	304014195 S	1/2017	
CN	304056625 S	2/2017	
CN	304056650 S	2/2017	
CN	304104367 S	4/2017	
CN	304116716 S	4/2017	
CN	304175743 S	6/2017	
CN	304191161 S	6/2017	
CN	304191165 S	6/2017	
CN	304270776 S	9/2017	
CN	304279388 S	9/2017	
CN	304306129 S	10/2017	

(56)

References Cited

FOREIGN PATENT DOCUMENTS

CN	304344294 S	11/2017
CN	304354072	11/2017
EM	000044466-0004	10/2003
EM	000049390-0001	10/2003
EM	000132790-0004	5/2004
EM	000146642-0001	6/2004
EM	000180823-0001	7/2004
EM	000176672-0001	8/2004
EM	000691977-0001	5/2007
EM	000775986-0007	8/2007
EM	000639311-0003	1/2008
EM	000913298-0017	5/2008
EM	000913298-0025	5/2008
EM	000930722-0004	5/2008
EM	001603069-0007	8/2009
EM	001603069-0009	8/2009
EM	001603069-0010	8/2009
EM	001605163-0001	9/2009
EM	001657867-0004	1/2010
EM	001657867-0003	2/2010
EM	001730946-0002	7/2010
EM	002294181-0001	8/2013
EM	002482158-0001	6/2014
EM	002622332-0003	1/2015
EM	002834226-0002	11/2015
EM	003435965-0001	1/2017
GB	2065450	5/1997
JP	1078633	7/2000
JP	1125530	11/2001
JP	1142159	5/2002
JP	1142263	5/2002
JP	1182477	8/2003
JP	1182480	8/2003
JP	1253840	4/2004
JP	1226392	12/2004
JP	1226408	12/2004
JP	1228616	1/2005
JP	1244595	7/2005
JP	1249477	8/2005

JP	1249478	8/2005
JP	1254151	10/2005
JP	1270247	5/2006
JP	1281984	9/2006
JP	1254084	10/2006
JP	1254403	10/2006
JP	1261906	1/2007
JP	1335074	7/2008
JP	1339864	9/2008
JP	1376014	12/2009
JP	1405982	1/2011
JP	1524973	6/2015
KR	300778965.0000	1/2015
KR	300844291.0000	3/2016
KR	300866651.0000	7/2016
KR	300867682.0000	8/2016
KR	300906526.0000	5/2017
KR	300911751.0000	6/2017
KR	300915848.0000	7/2017
KR	300933857.0000	11/2017
WO	078154	5/2012
WO	081439-0004	8/2013
WO	082316-0003	12/2013
WO	085822	3/2015
WO	090425-0001	5/2016
WO	094044-0001	1/2017

OTHER PUBLICATIONS

Office Action for U.S. Appl. No. 29/637,291, dated Mar. 29, 2018, Siminoff et al., "Wireless Entrance Communication Device", 5 pages.

Office Action for U.S. Appl. No. 29/637,325, dated Mar. 29, 2018, Siminoff et al., "Wireless Entrance Communication Device", 5 pages.

Non Final Office Action dated Mar. 7, 2019 for U.S. Appl. 29/654,873 "Wireless Entrance Communication Device" Siminoff, 5 pages.

Non-Final Office Action for U.S. Appl. No. 29/667,605, dated Jan. 28, 2019, Siminoff et al., "Wireless Entrance Communication Device", 5 pages.

* cited by examiner

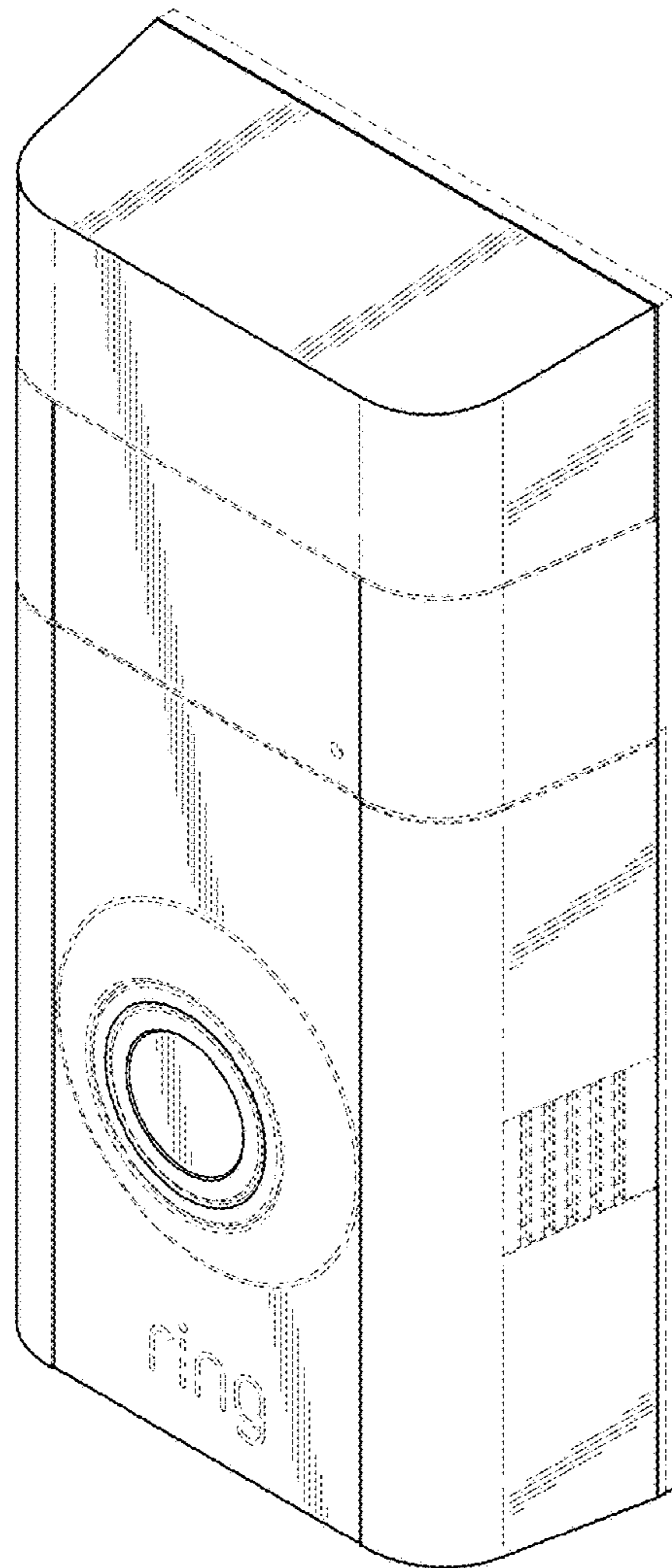

FIG. 1

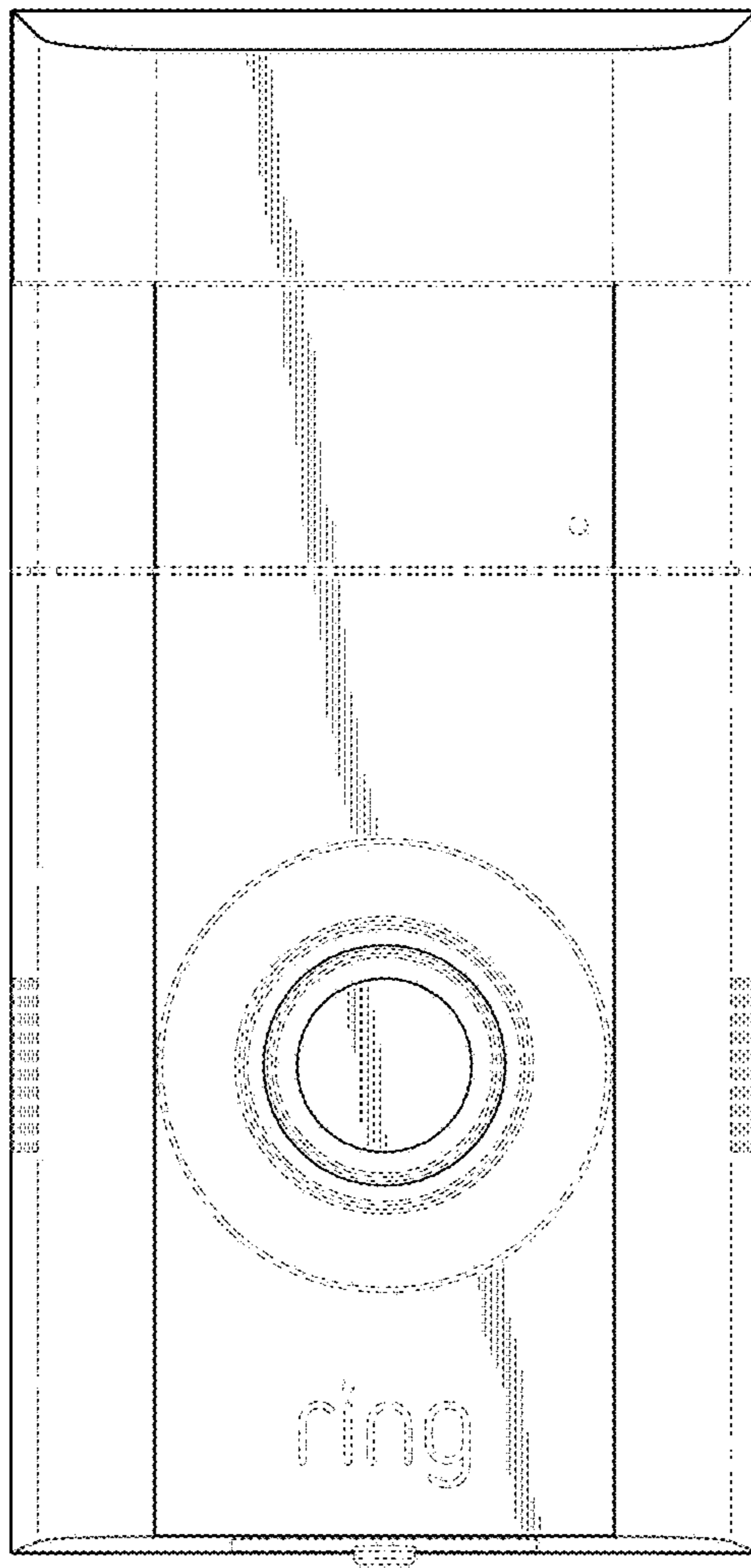

FIG. 2

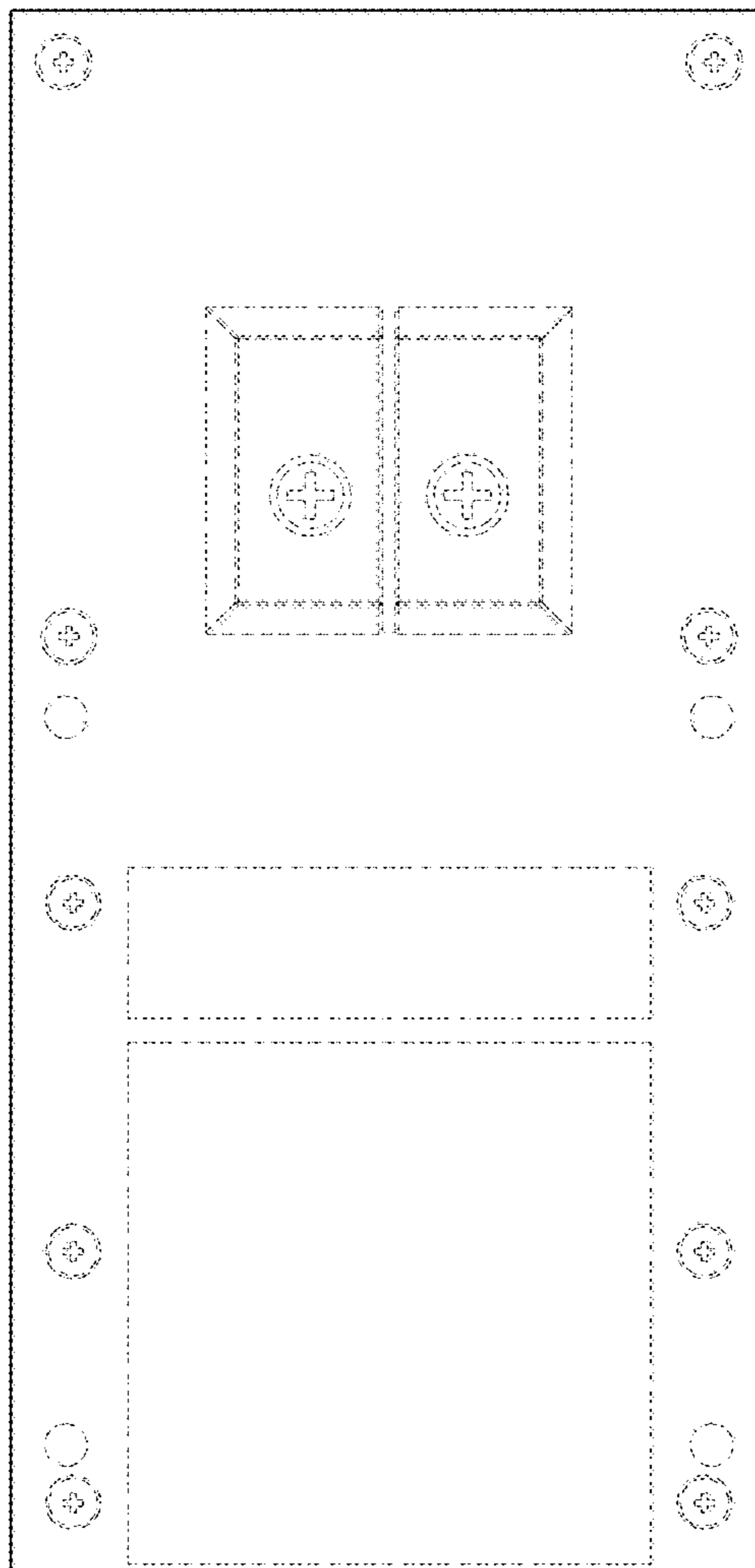

FIG. 3

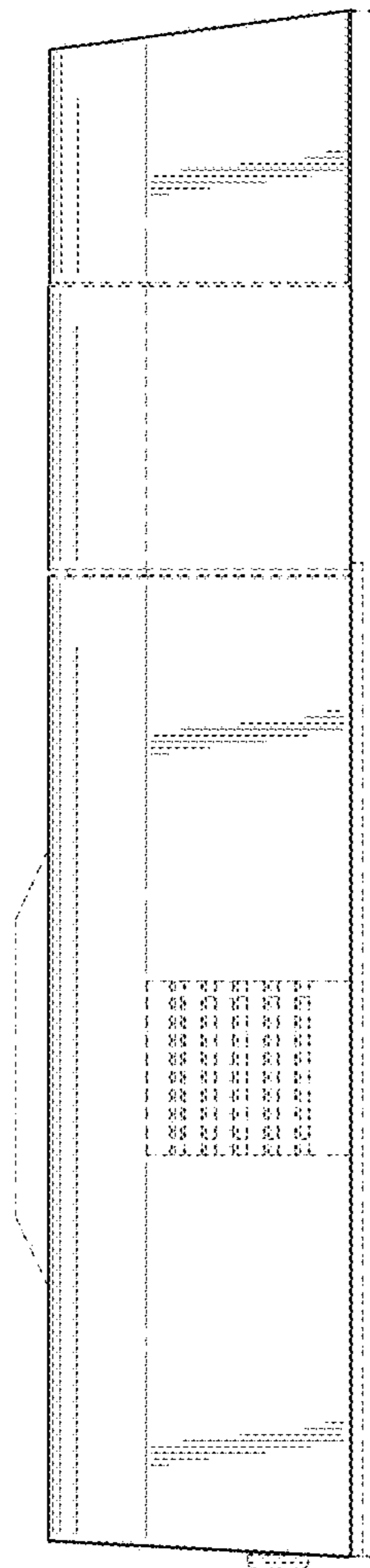

FIG. 4

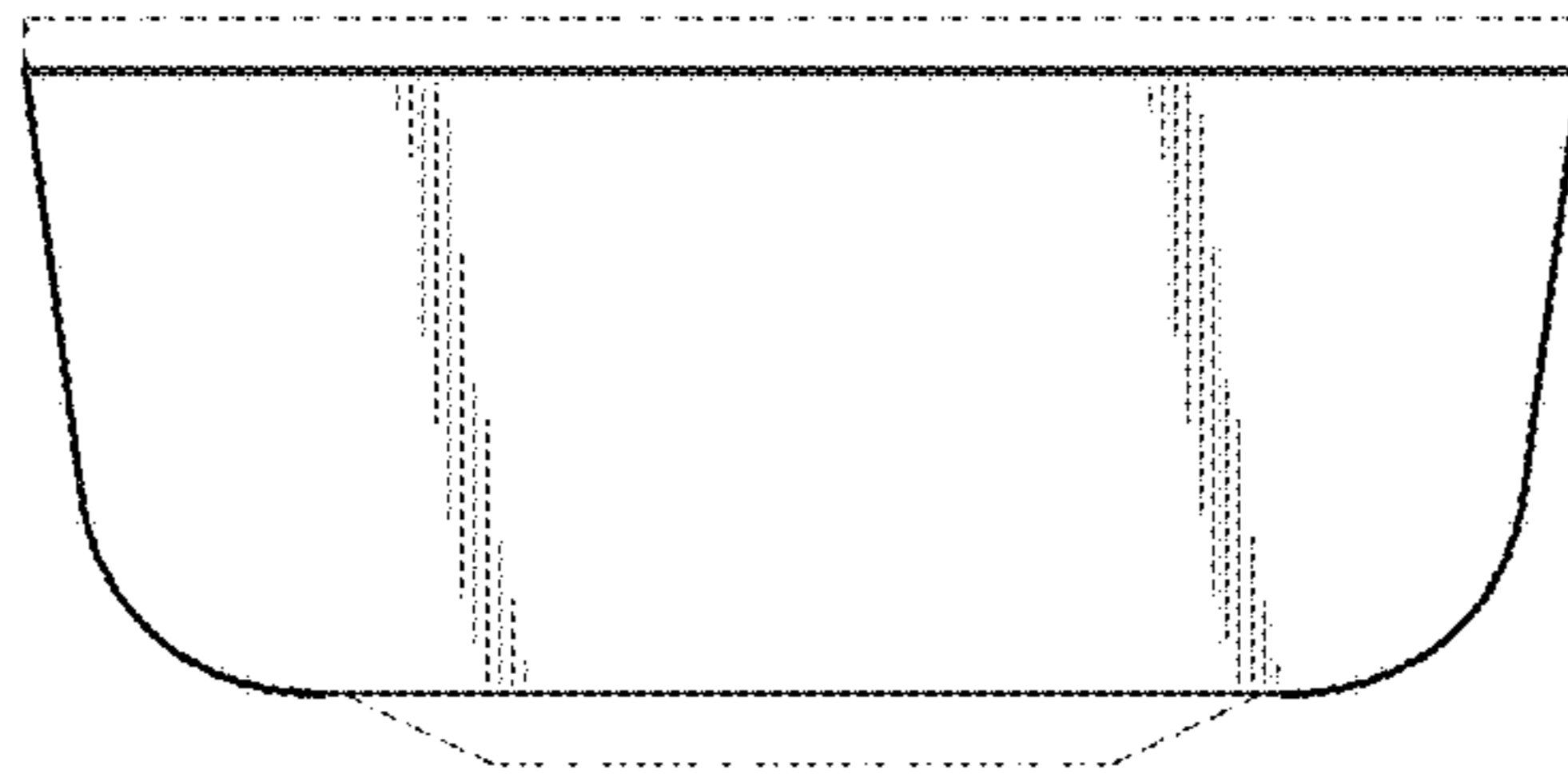

FIG. 5

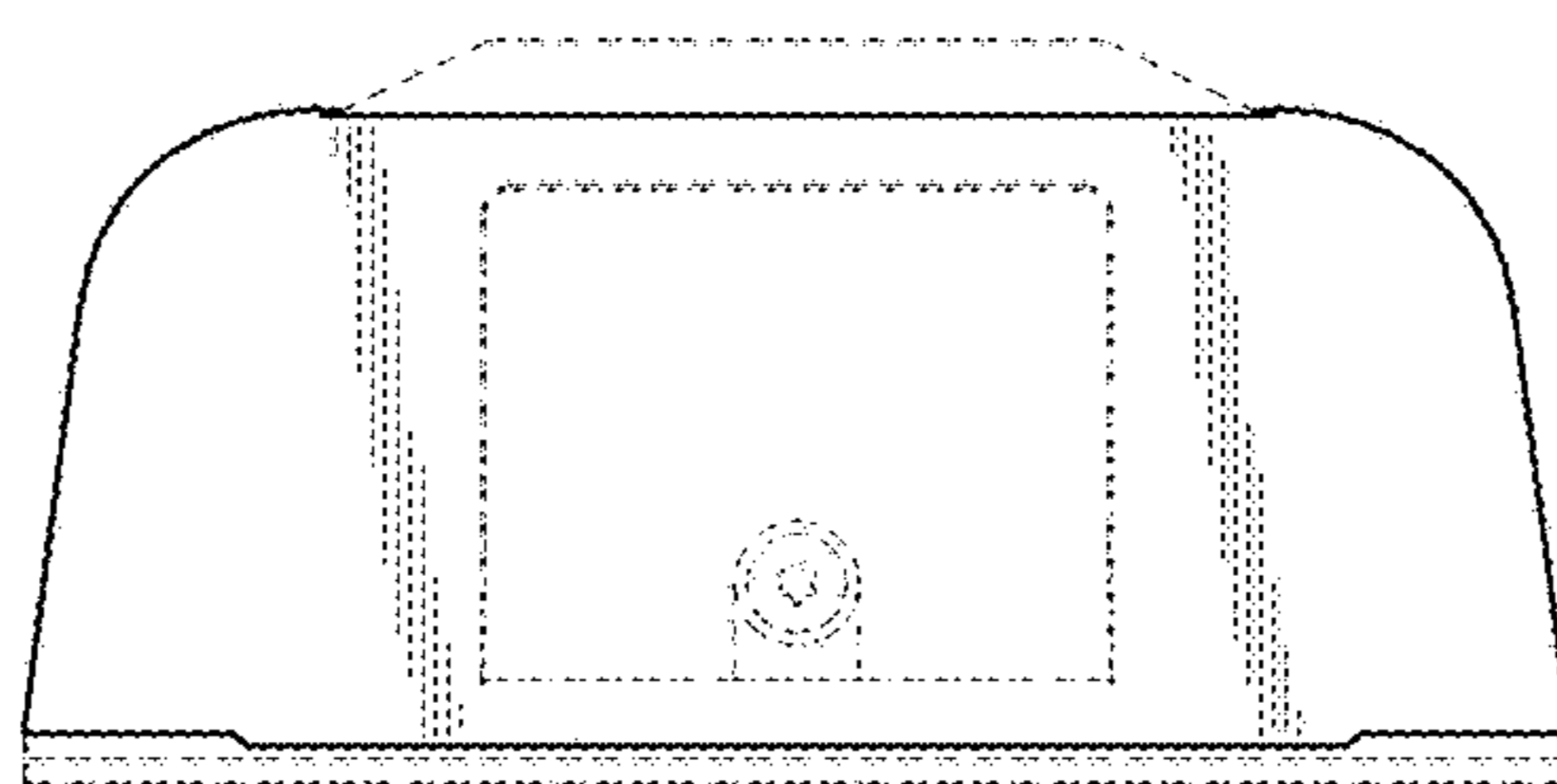

FIG. 6