



US00D866287S

(12) **United States Design Patent** (10) **Patent No.:** **US D866,287 S**
Broussard (45) **Date of Patent:** **** Nov. 12, 2019**

(54) **MULTIPURPOSE TRUCKER TOOL**
(71) Applicant: **Allan Lee Broussard**, Sherwood, AR (US)
(72) Inventor: **Allan Lee Broussard**, Sherwood, AR (US)
(**) Term: **15 Years**
(21) Appl. No.: **29/679,341**
(22) Filed: **Feb. 5, 2019**
(51) **LOC (12) Cl.** **08-05**
(52) **U.S. Cl.**
USPC **D8/105**
(58) **Field of Classification Search**
USPC D8/105, 14, 47, 75-77, 80, 81, 88, 89, D8/107; D3/7
CPC . B62D 53/08; B66F 3/00; B66F 15/00; B25F 1/00
See application file for complete search history.

D490,031 S 5/2004 Sanchez
7,347,467 B2 3/2008 Theobald
D644,830 S * 9/2011 Jones D3/7
8,851,453 B2 * 10/2014 de Zwart B65D 90/66
254/131
9,095,969 B1 * 8/2015 Oswald B25J 1/04
D738,183 S * 9/2015 Burson D8/105
D738,699 S * 9/2015 Hicks D8/105
D740,015 S * 10/2015 Berberian D3/7
D751,874 S * 3/2016 Hills D8/105
D769,090 S * 10/2016 Pia D8/14
D807,022 S 1/2018 Conley
10,174,520 B1 * 1/2019 Benson B25B 27/02
2003/0201651 A1 * 10/2003 Lockhart B62D 53/08
294/17
2015/0314435 A1 11/2015 Oswald
2018/0334202 A1 * 11/2018 Broussard B66F 15/00

* cited by examiner

Primary Examiner — Janice Hallmark
(74) *Attorney, Agent, or Firm* — Rashauna Norment

(57) **CLAIM**

The ornamental design for a multipurpose trucker tool, as shown and described.

DESCRIPTION

FIG. 1 is a perspective view of a multipurpose trucker tool, showing my new design;
FIG. 2 is a front elevation view of FIG. 1 thereof;
FIG. 3 is a rear elevation view of FIG. 1 thereof;
FIG. 4 is a bottom plan view of FIG. 1 thereof;
FIG. 5 is a top plan view of FIG. 1 thereof;
FIG. 6 is a left side elevation view of FIG. 1 thereof; and,
FIG. 7 is a right side elevation view of FIG. 1 thereof.

1 Claim, 3 Drawing Sheets

(56) **References Cited**
U.S. PATENT DOCUMENTS
D308,005 S * 5/1990 Nickert D8/105
D330,280 S 10/1992 Glassman
5,344,201 A * 9/1994 Offin B25F 1/00
294/175
5,378,007 A * 1/1995 Joyce B62D 53/08
280/407
5,423,567 A * 6/1995 Upton B62D 53/08
254/129
D377,924 S * 2/1997 Christensen D12/161
D384,253 S 9/1997 Patino
D475,258 S 6/2003 Wilson

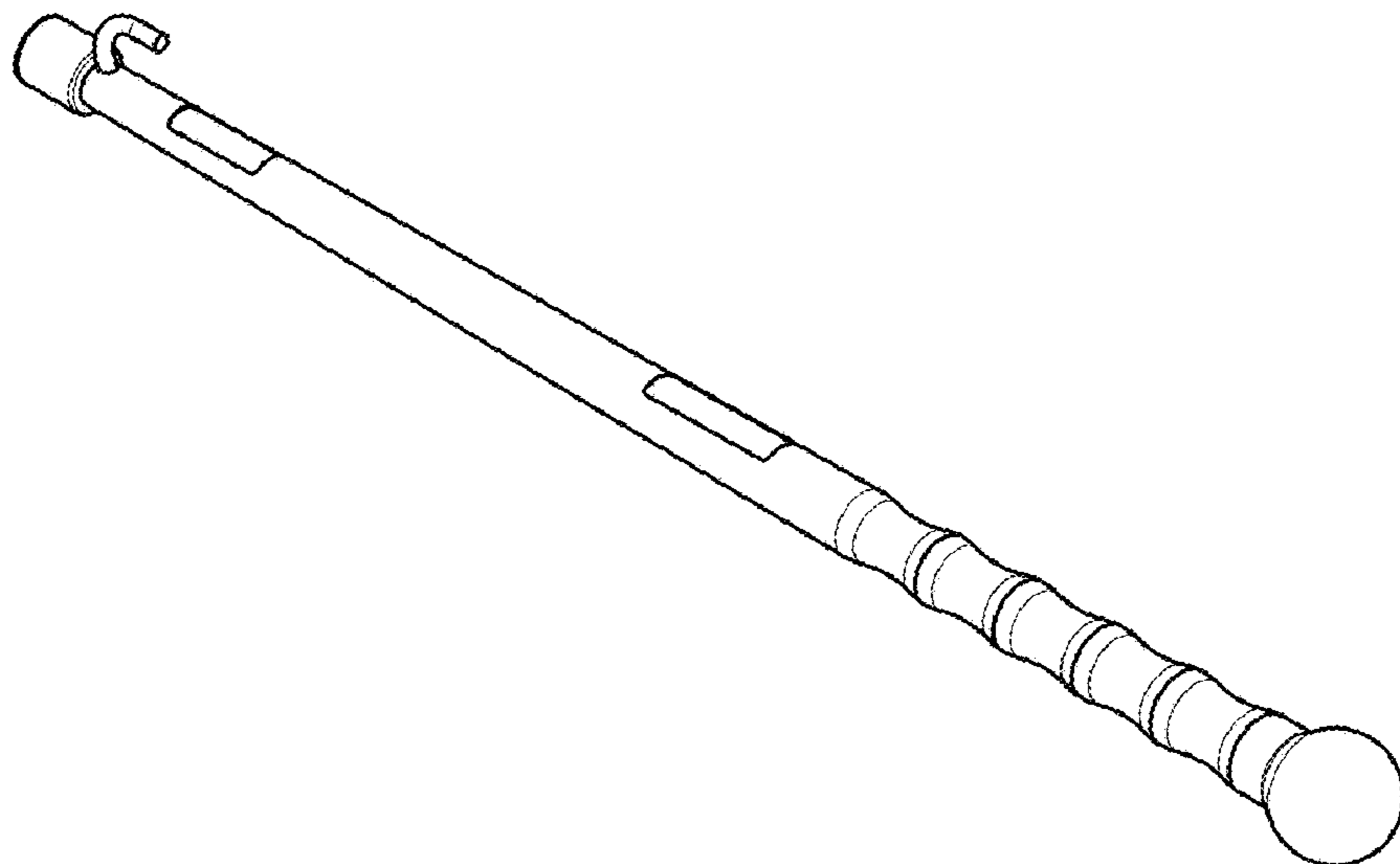

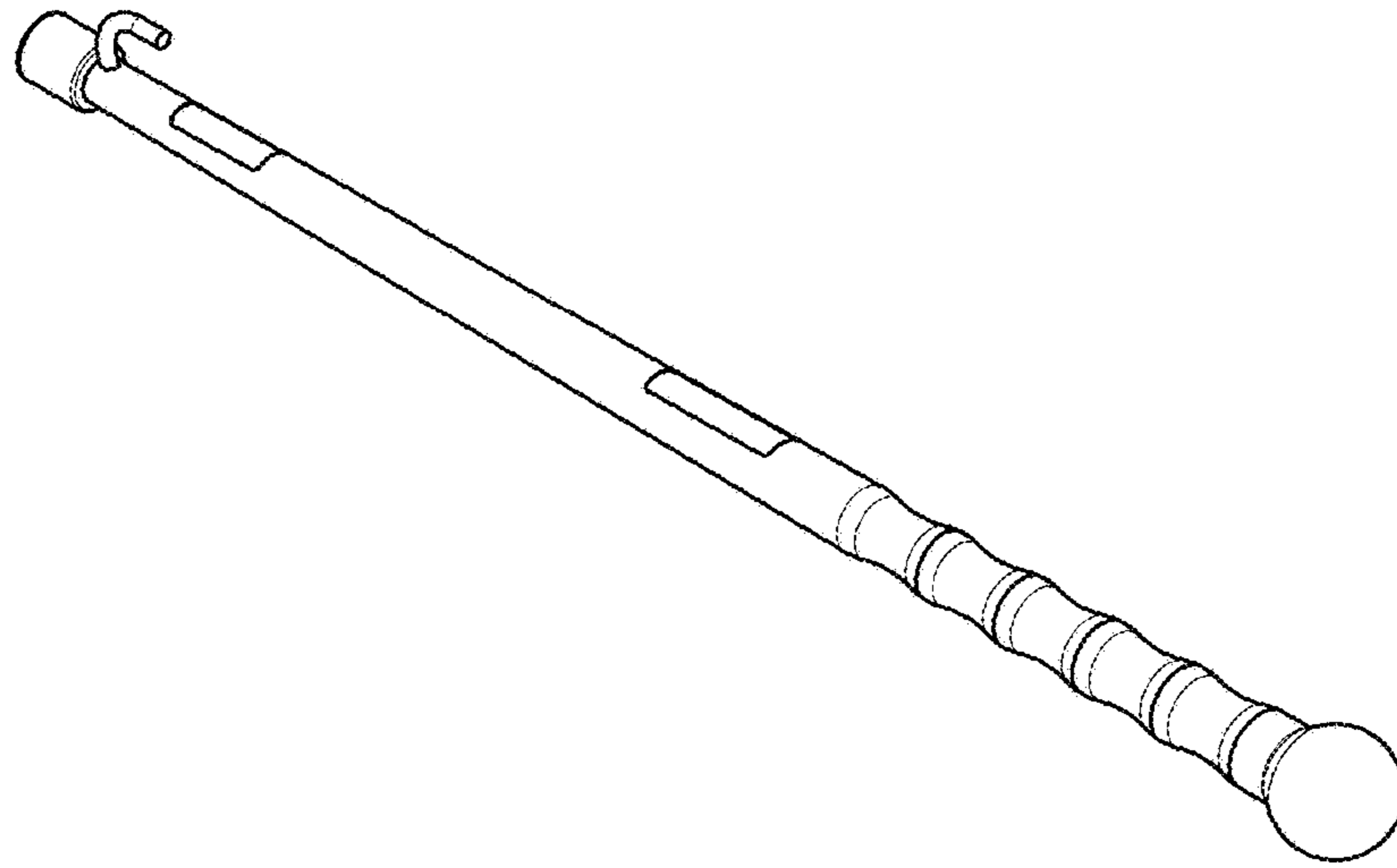

Fig. 1

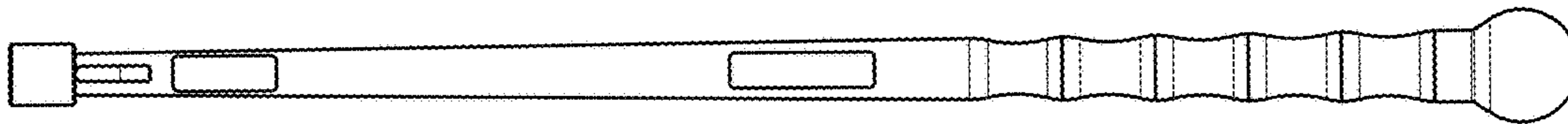

Fig. 2

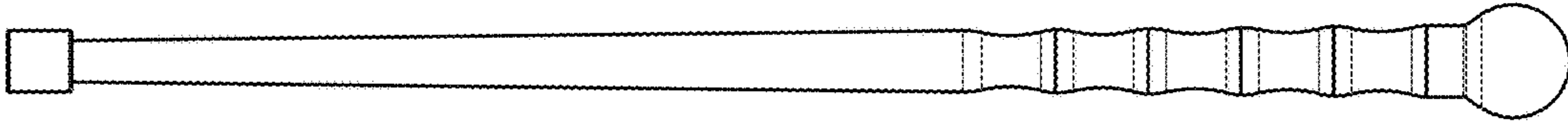

Fig. 3

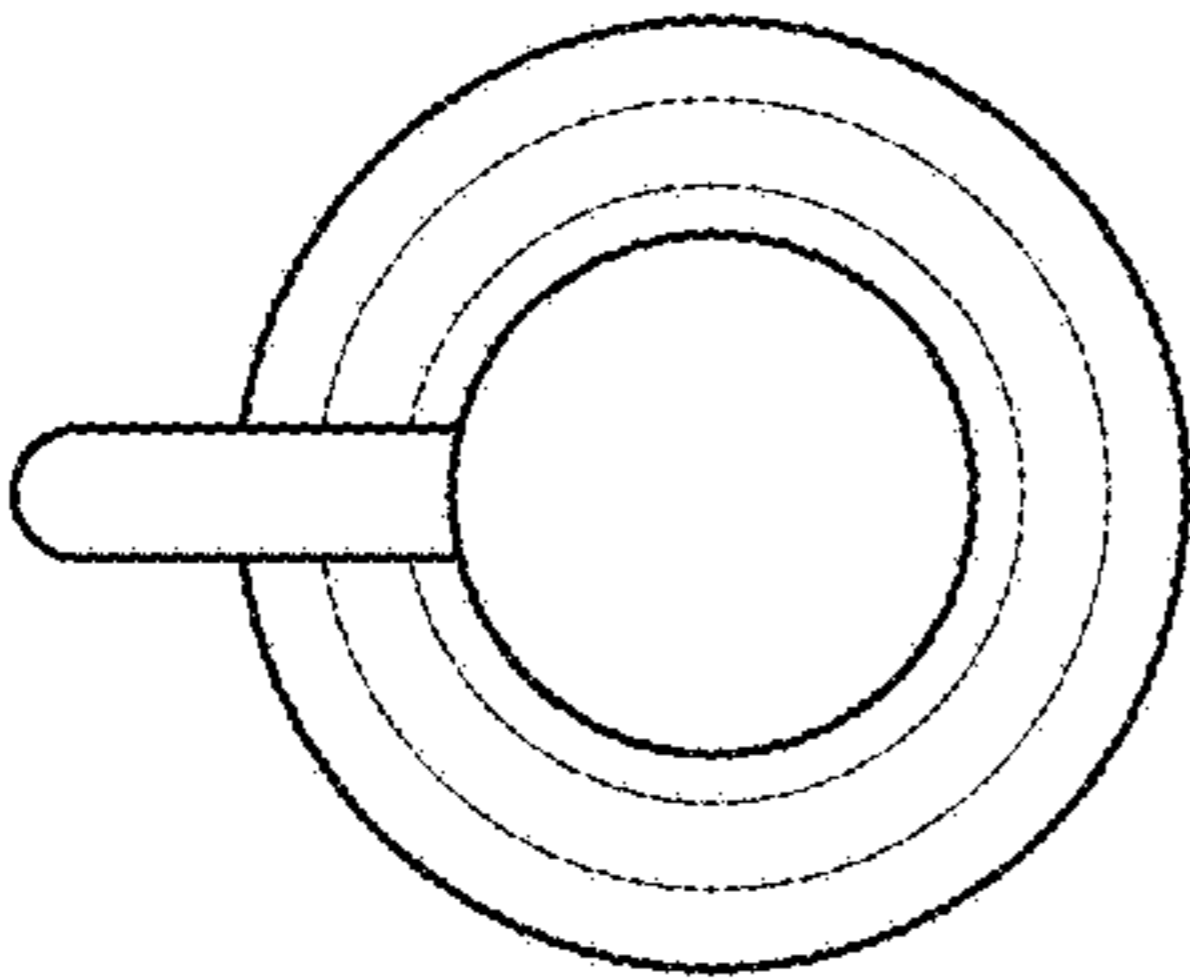

Fig. 4

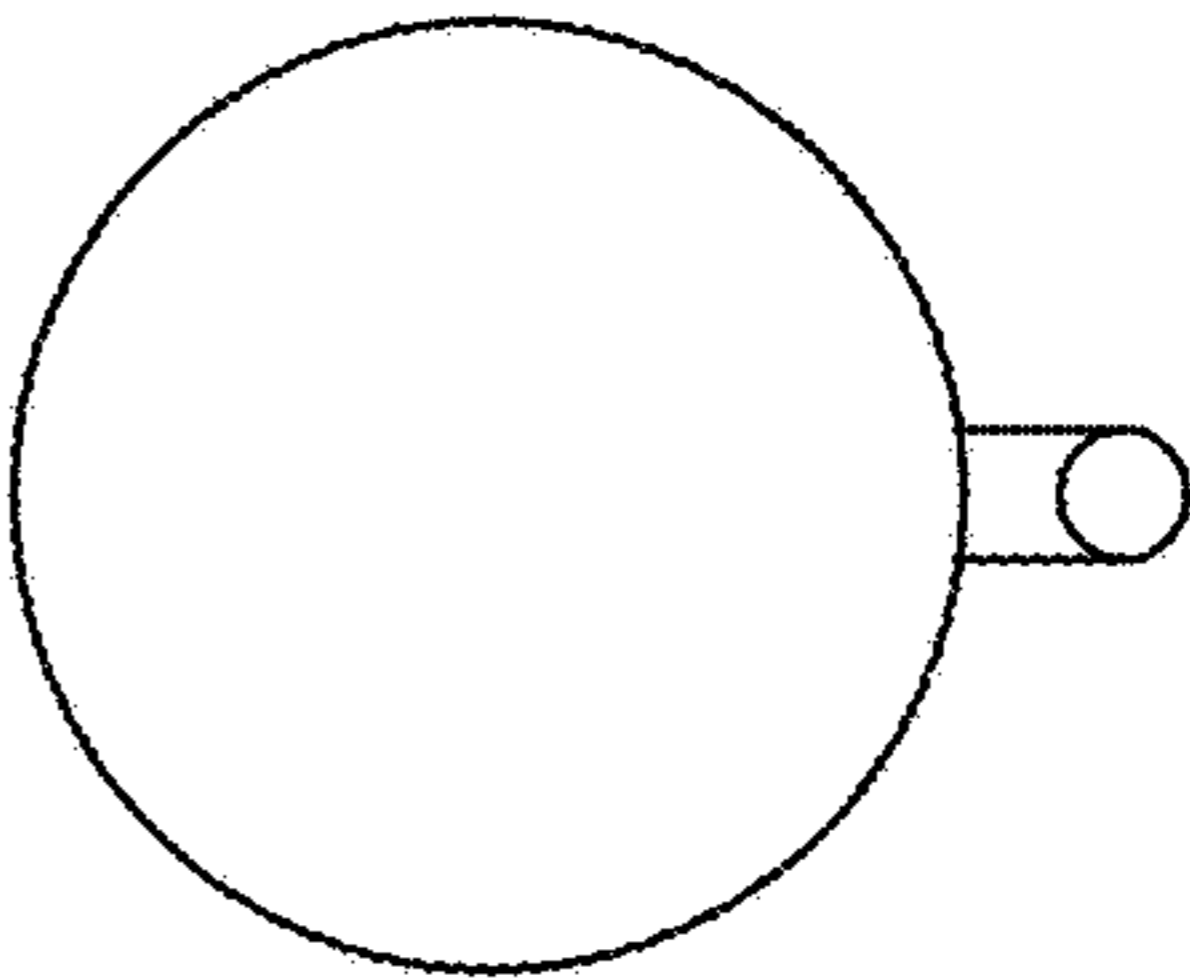

Fig. 5

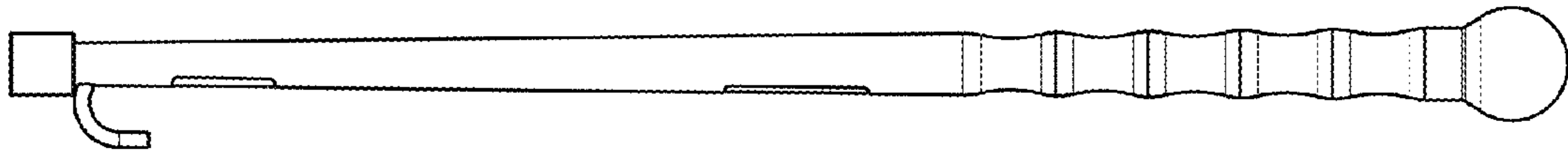

Fig. 6

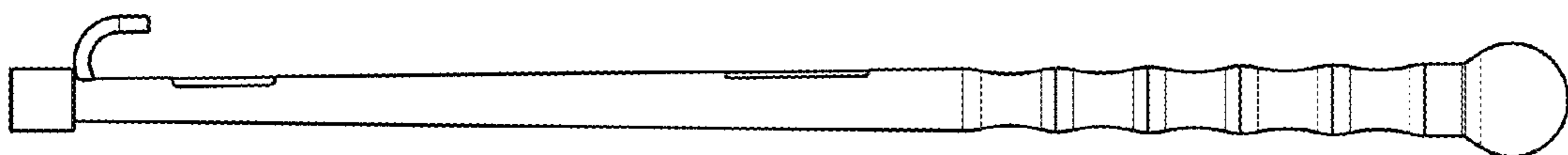

Fig. 7