



US00D866267S

(12) **United States Design Patent** (10) **Patent No.:** **US D866,267 S**
Carey et al. (45) **Date of Patent:** **** Nov. 12, 2019**

(54) **COOLER**

(71) Applicant: **THE METAL WARE CORPORATION**, Two Rivers, WI (US)

(72) Inventors: **Richard Carey**, Manitowoc, WI (US); **Ross Niemi**, Two Rivers, WI (US)

(73) Assignee: **THE METAL WARE CORPORATION**, Two Rivers, WI (US)

(**) Term: **15 Years**

(21) Appl. No.: **29/627,600**

(22) Filed: **Nov. 28, 2017**

Related U.S. Application Data

(63) Continuation of application No. 29/553,277, filed on Jan. 29, 2016, now Pat. No. Des. 807,123.

(51) **LOC (12) Cl.** **07-01**

(52) **U.S. Cl.**
USPC **D7/605**

(58) **Field of Classification Search**
USPC D7/605–608, 629, 630, 709, 710;
D3/272–274

CPC B65D 81/3888; B65D 81/38;
B65D 81/3813; B65D 81/3816; B65D 81/3818;
B65D 81/3823; B65D 81/3858;
A45C 11/20; A45C 5/14; A45C 5/03;
A45C 9/00; A45F 3/46; F25D 3/02; F25D 3/04;
F25D 3/06; F25D 3/08; F25D 3/11;
F25D 3/14; F25D 2331/804; F25D 31/005;
A47B 77/08; A47J 41/022; A47G 19/2288;
B26B 3/003; F25B 19/00

See application file for complete search history.

(56) **References Cited**

U.S. PATENT DOCUMENTS

1,483,953 A	2/1924	Rainey
D70,542 S	7/1926	Davis
1,699,313 A	1/1929	Schlaich

(Continued)

Primary Examiner — Terry A Wallace

(74) *Attorney, Agent, or Firm* — Seager, Tufte & Wickhem LLP

(57) **CLAIM**

The ornamental design for a cooler, as shown and described.

DESCRIPTION

FIG. 1 is a top perspective view of an embodiment of a cooler;

FIG. 2 is a front side view of the cooler of FIG. 1;

FIG. 3 is a back side view of the cooler of FIG. 1;

FIG. 4 is a left side view of the cooler of FIG. 1;

FIG. 5 is a right side view of the cooler of FIG. 1;

FIG. 6 is a top side view of the cooler of FIG. 1;

FIG. 7 is a bottom side view of the cooler of FIG. 1;

FIG. 8 is a top perspective view of a further embodiment of a cooler;

FIG. 9 is a front side view of the cooler of FIG. 8;

FIG. 10 is a back side view of the cooler of FIG. 8;

FIG. 11 is a left side view of the cooler of FIG. 8;

FIG. 12 is a right side view of the cooler of FIG. 8;

FIG. 13 is a top side view of the cooler of FIG. 8;

FIG. 14 is a bottom side view of the cooler of FIG. 8;

FIG. 15 is a top perspective view of a further embodiment of a cooler;

FIG. 16 is a front side view of the cooler of FIG. 15;

FIG. 17 is a back side view of the cooler of FIG. 15;

FIG. 18 is a left side view of the cooler of FIG. 15;

FIG. 19 is a right side view of the cooler of FIG. 15;

FIG. 20 is a top side view of the cooler of FIG. 15; and,

FIG. 21 is a bottom side view of the cooler of FIG. 15.

The broken lines in the drawings illustrate portions in the article that form no part of the claim.

1 Claim, 21 Drawing Sheets

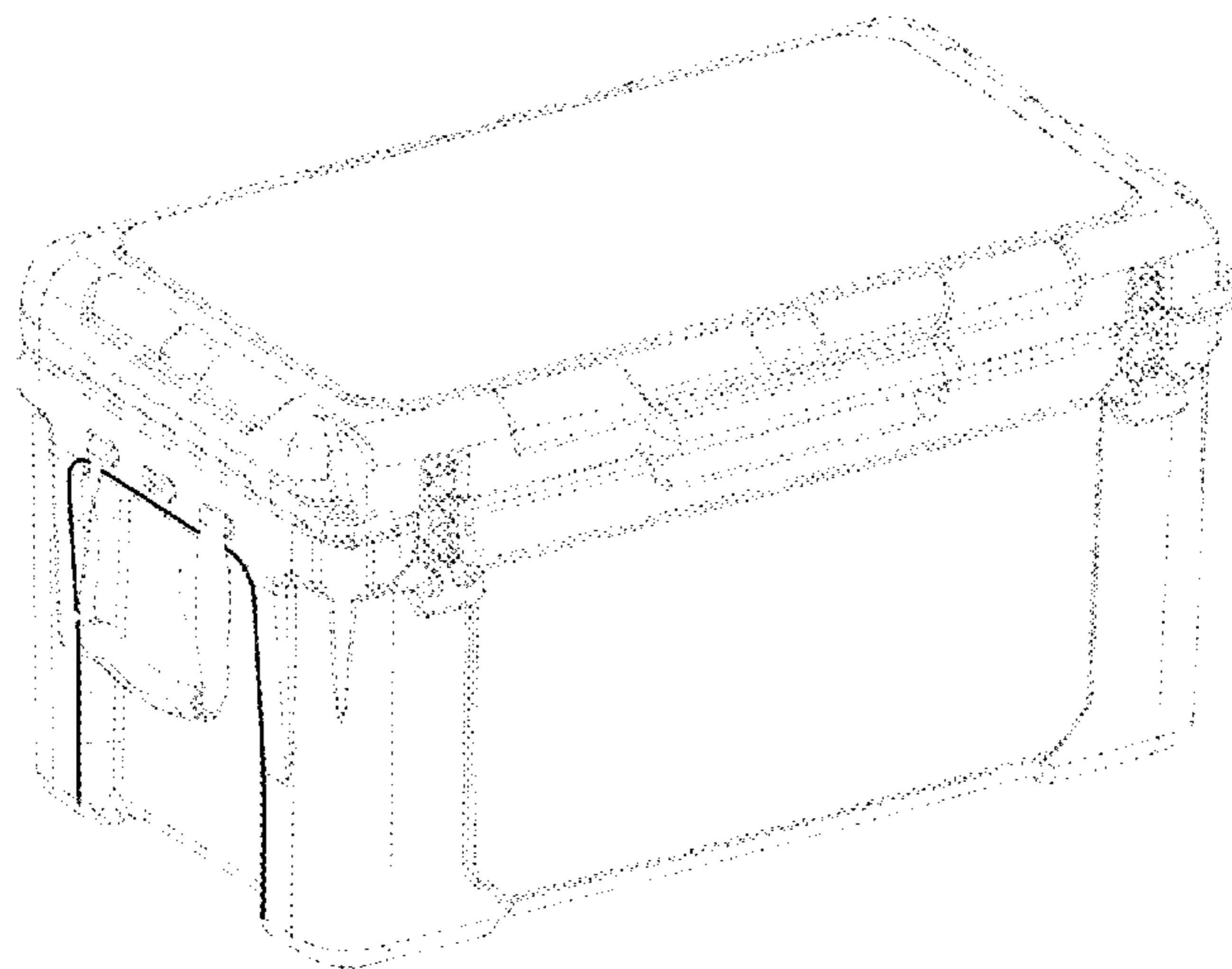

(56)

References Cited

U.S. PATENT DOCUMENTS

2,960,216 A	11/1960	Brady		D467,470 S	12/2002	Cantor et al.	
D210,795 S	4/1968	Birger		D467,770 S	12/2002	Blalock	
3,782,765 A	1/1974	Wallyn		D475,248 S	6/2003	Cantor et al.	
D232,798 S	9/1974	Roche		D486,457 S	2/2004	Lee	
D237,135 S	10/1975	Wiant		D494,021 S *	8/2004	Huthmaker	D7/605
4,024,731 A *	5/1977	Branscum	B65D 81/3823 62/457.2	D511,247 S	11/2005	Tsuchiya	
D257,934 S	1/1981	Buss		D511,624 S	11/2005	Rosine et al.	
D259,232 S	5/1981	Tarozzi		D521,810 S	5/2006	Estes	
D266,822 S	11/1982	Seager		D527,225 S *	8/2006	Krieger	D7/605
D270,604 S	9/1983	Zauft		D528,368 S	9/2006	Maldonado	
D281,695 S	12/1985	Ryan, Jr.		D536,580 S *	2/2007	Krieger	D7/605
D283,480 S	4/1986	Bailey		D552,426 S *	10/2007	Jones	D7/605
D283,966 S	5/1986	Carlson		D560,102 S	1/2008	Sumter	
D291,858 S	9/1987	Baker et al.		D563,731 S	3/2008	Thurston	
4,702,504 A	10/1987	Brothers		D566,479 S *	4/2008	Kabalin	D3/273
D305,397 S	1/1990	Balius		7,389,608 B1 *	6/2008	MacKay	A01K 97/05 206/315.11
D307,998 S	5/1990	Costello et al.		D575,059 S	8/2008	Cappiello et al.	
D318,175 S *	7/1991	Venanzini	D3/260	D587,972 S	3/2009	Dorisca et al.	
D322,198 S	12/1991	Dringenburg		7,533,782 B2	5/2009	Parker et al.	
D325,323 S *	4/1992	Kahl	D7/605	7,540,364 B2	6/2009	Sanderson	
D325,324 S	4/1992	Kahl		D604,994 S	12/2009	Greenlees et al.	
D325,853 S	5/1992	Kahl		D613,109 S	4/2010	Sanchez et al.	
D328,221 S	7/1992	Piccarillo		D613,560 S	4/2010	Robichaud et al.	
D328,689 S	8/1992	Riskowski		7,722,204 B1	5/2010	Sandberg	
D330,329 S	10/1992	Brightbill		D634,982 S	3/2011	Melchert et al.	
D333,775 S	3/1993	Krape		D637,459 S	5/2011	Giese	
D334,868 S	4/1993	Woon		D640,102 S	6/2011	Hawkins	
D340,167 S	10/1993	Kahl		D645,248 S	9/2011	Osiecki et al.	
D340,620 S	10/1993	Peters		D646,528 S	10/2011	Stallman et al.	
D349,007 S	7/1994	Costello		D651,860 S *	1/2012	Nie	D7/605
D351,318 S	10/1994	Wedi		D652,262 S *	1/2012	Yang	D7/605
D352,208 S	11/1994	Brookshire		D660,885 S	5/2012	Crawford	
D353,304 S	12/1994	Friedrich		8,210,702 B1	7/2012	Sandberg	
D354,419 S *	1/1995	Kahl	D7/605	D694,070 S	11/2013	Torres	
D366,599 S	1/1996	Brown et al.		D712,720 S	9/2014	Seiders	
D369,722 S	5/1996	Lopez et al.		D712,721 S	9/2014	Seiders	
D370,159 S	5/1996	Fenton et al.		D712,722 S	9/2014	Seiders	
D374,772 S *	10/1996	Hotaling	D3/273	D712,723 S	9/2014	Seiders	
D376,068 S	12/1996	Coy		D714,125 S	9/2014	Seiders	
5,607,195 A	3/1997	Antonucci		8,875,934 B2 *	11/2014	Deka	B65D 81/3823 220/23.88
D380,369 S	7/1997	Antonucci		8,887,515 B2 *	11/2014	Patstone	F25D 3/08 62/457.2
D386,649 S	11/1997	Arnfelt		8,910,819 B2	12/2014	Seiders	
5,683,097 A	11/1997	Fenton et al.		9,187,232 B2	11/2015	Seiders	
5,735,428 A	4/1998	Chern		D747,950 S	1/2016	Jacobsen et al.	
5,738,238 A	4/1998	Yang		D747,951 S	1/2016	Jacobsen et al.	
5,742,990 A	4/1998	Antonucci		D748,452 S	2/2016	Jacobsen et al.	
D394,550 S	5/1998	Tanji		D750,953 S	3/2016	Jacobsen et al.	
D396,779 S	8/1998	Moffett, III et al.		9,366,467 B2 *	6/2016	Kiedaisch	F25D 3/00
D397,585 S	9/1998	Rausch et al.		D807,123 S	1/2018	Carey et al.	
D398,816 S	9/1998	Koutsouflakis		2008/0025544 A1	1/2008	Maldonado	
D407,609 S	4/1999	Rausch		2008/0110892 A1	5/2008	House	
D415,393 S *	10/1999	Kei	D7/605	2009/0139245 A1 *	6/2009	Blackway	F25B 21/02 62/3.62
D415,658 S	10/1999	Frehse		2011/0203297 A1	8/2011	Oberweis	
D421,552 S	3/2000	Frehse		2012/0132657 A1 *	5/2012	Seiders	B65D 81/3816 220/592.2
D423,294 S	4/2000	Klein et al.		2013/0062356 A1 *	3/2013	Deka	B65D 81/3823 220/592.25
D429,606 S *	8/2000	Israel	D7/605	2014/0252010 A1	9/2014	Miller	
D437,736 S	2/2001	Moffett, III et al.		2015/0060470 A1 *	3/2015	Seiders	B65D 81/3816 292/194
6,182,462 B1 *	2/2001	Bania	A45C 11/20 62/264	2015/0369529 A1 *	12/2015	Monroe	F25D 3/08 62/457.2
D439,406 S	3/2001	Zimmerman					
D439,913 S	4/2001	Jobst					
D454,292 S	3/2002	Plummer et al.					
6,398,272 B1 *	6/2002	Plummer	E05C 19/06 292/246				

* cited by examiner

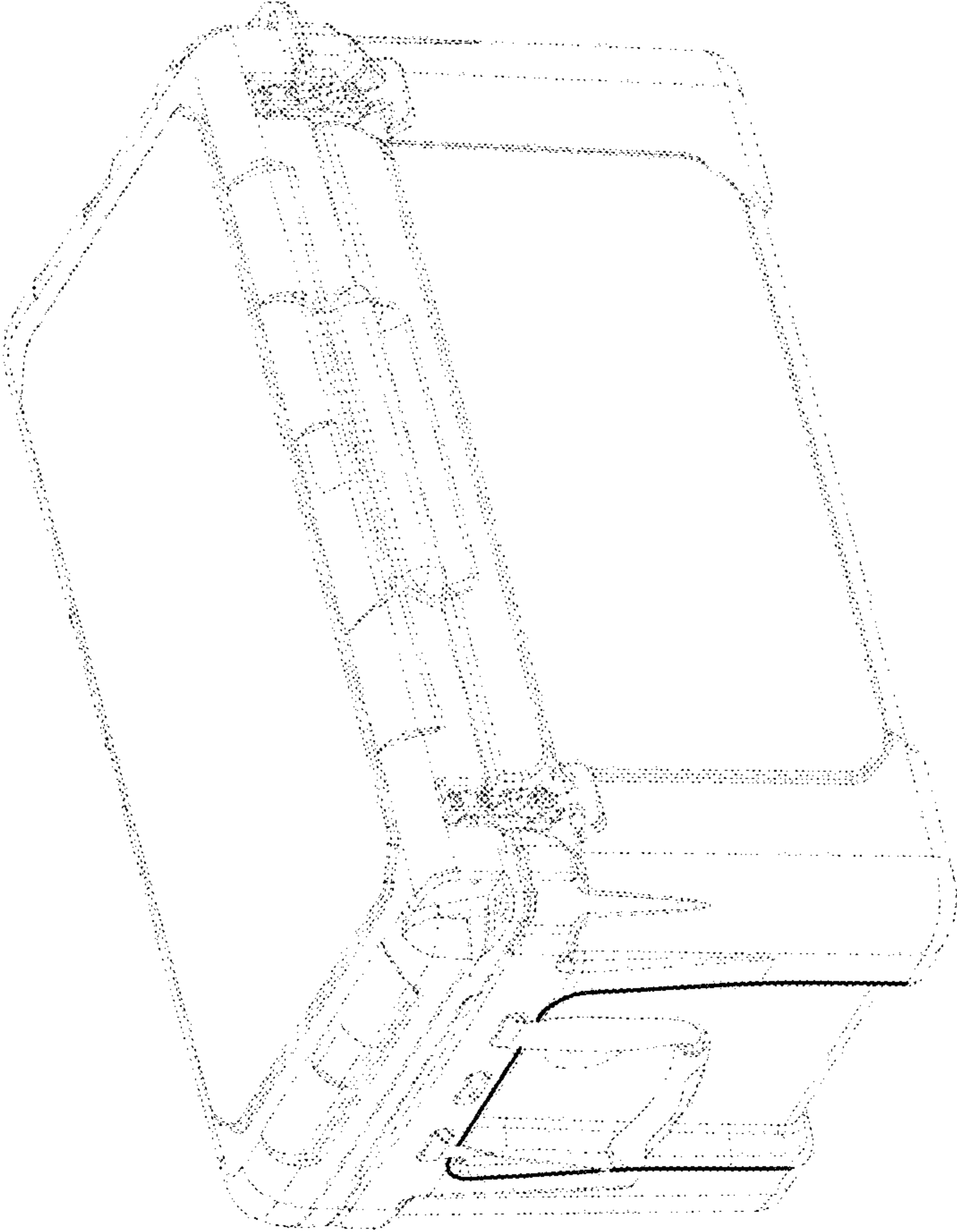

Figure 1

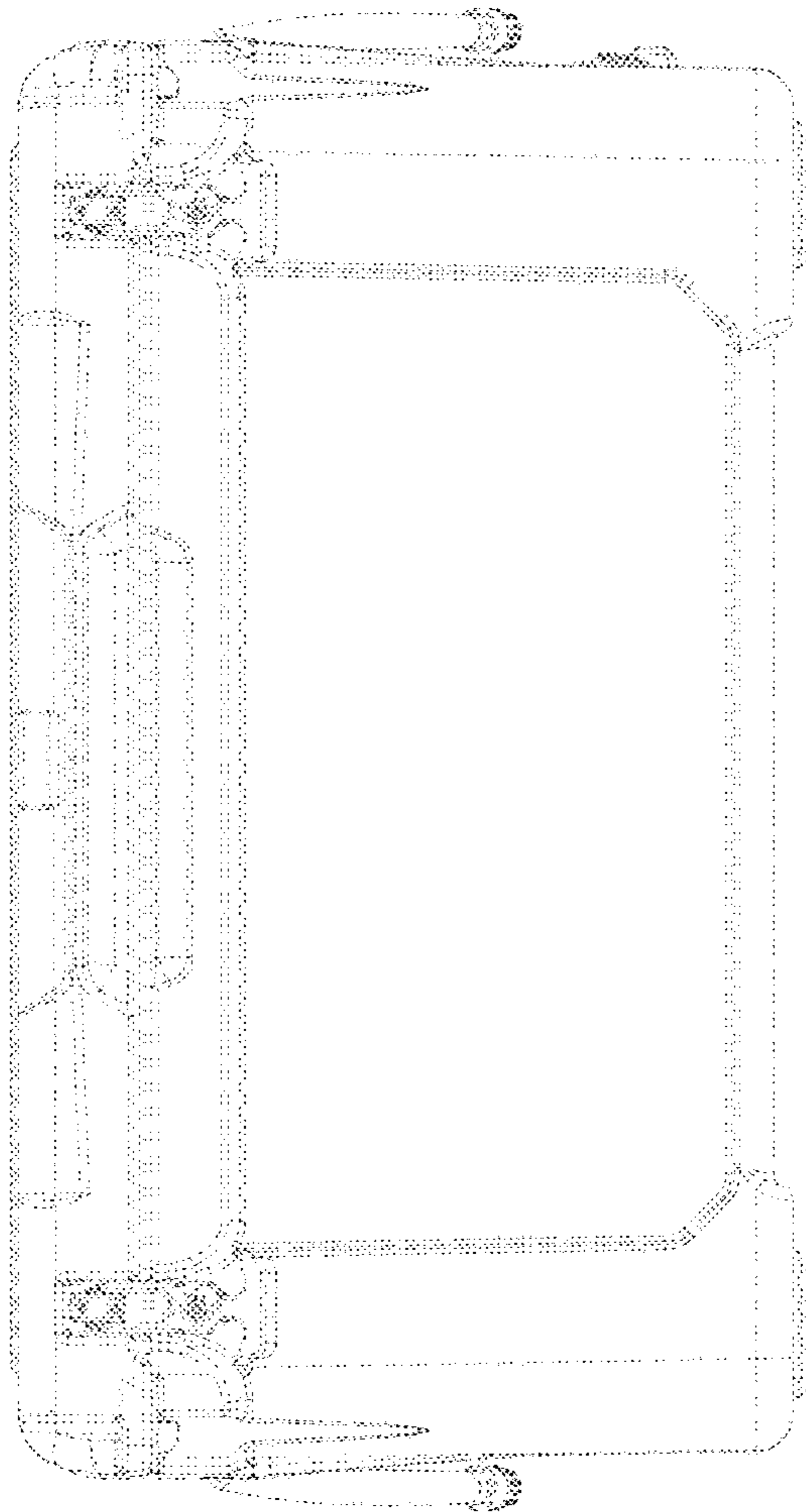

Figure 2

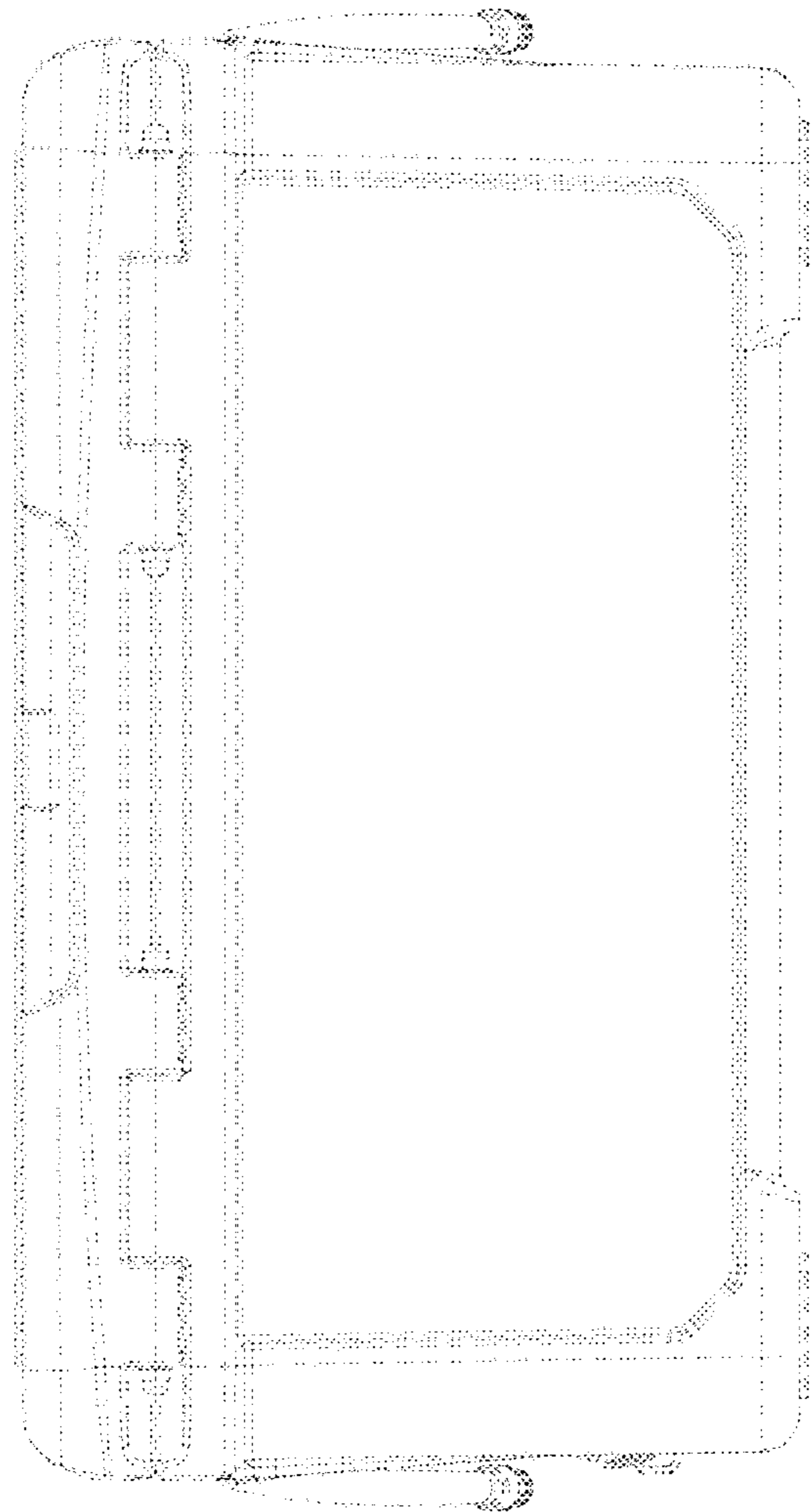

Figure 3

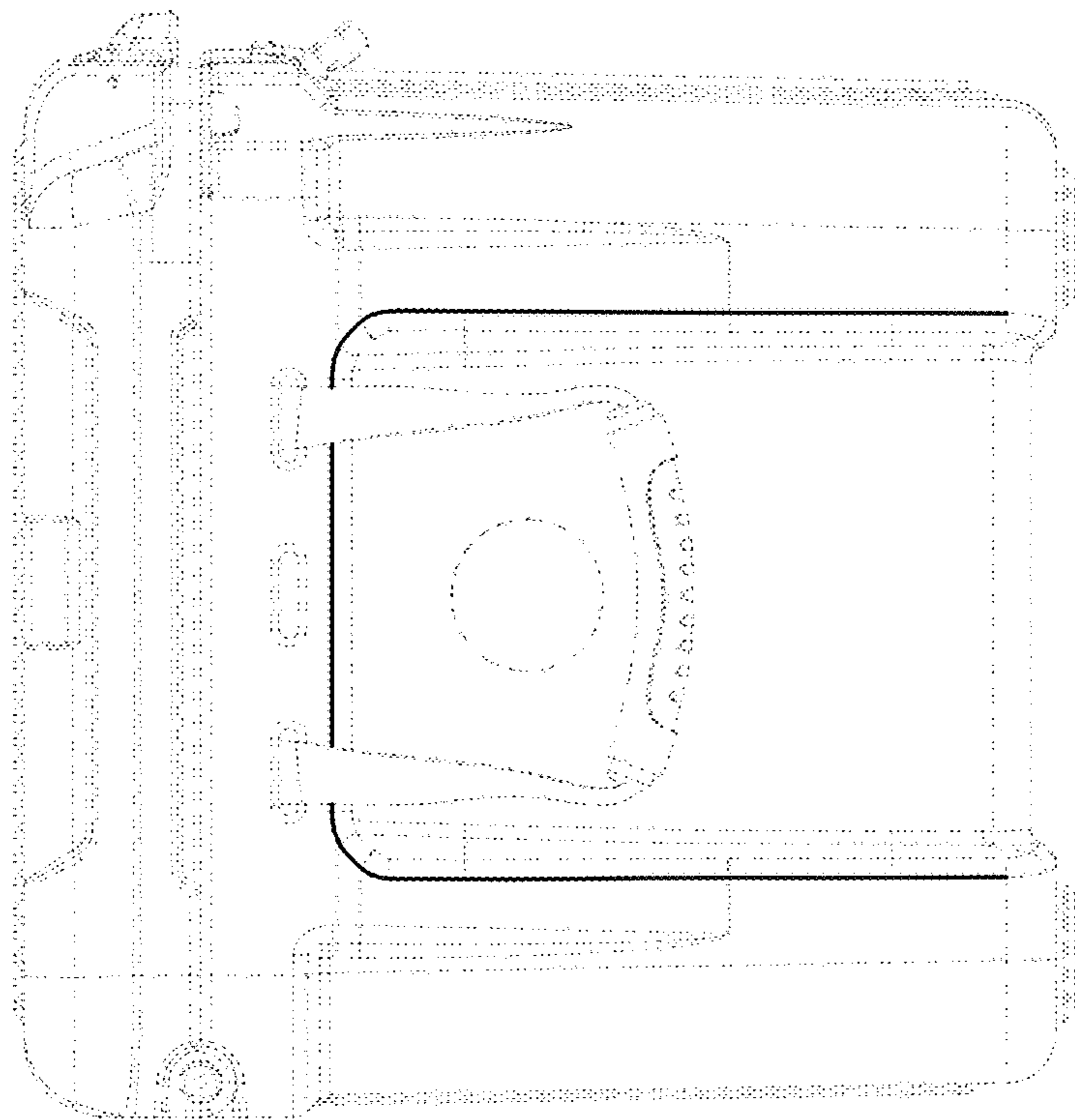

Figure 4

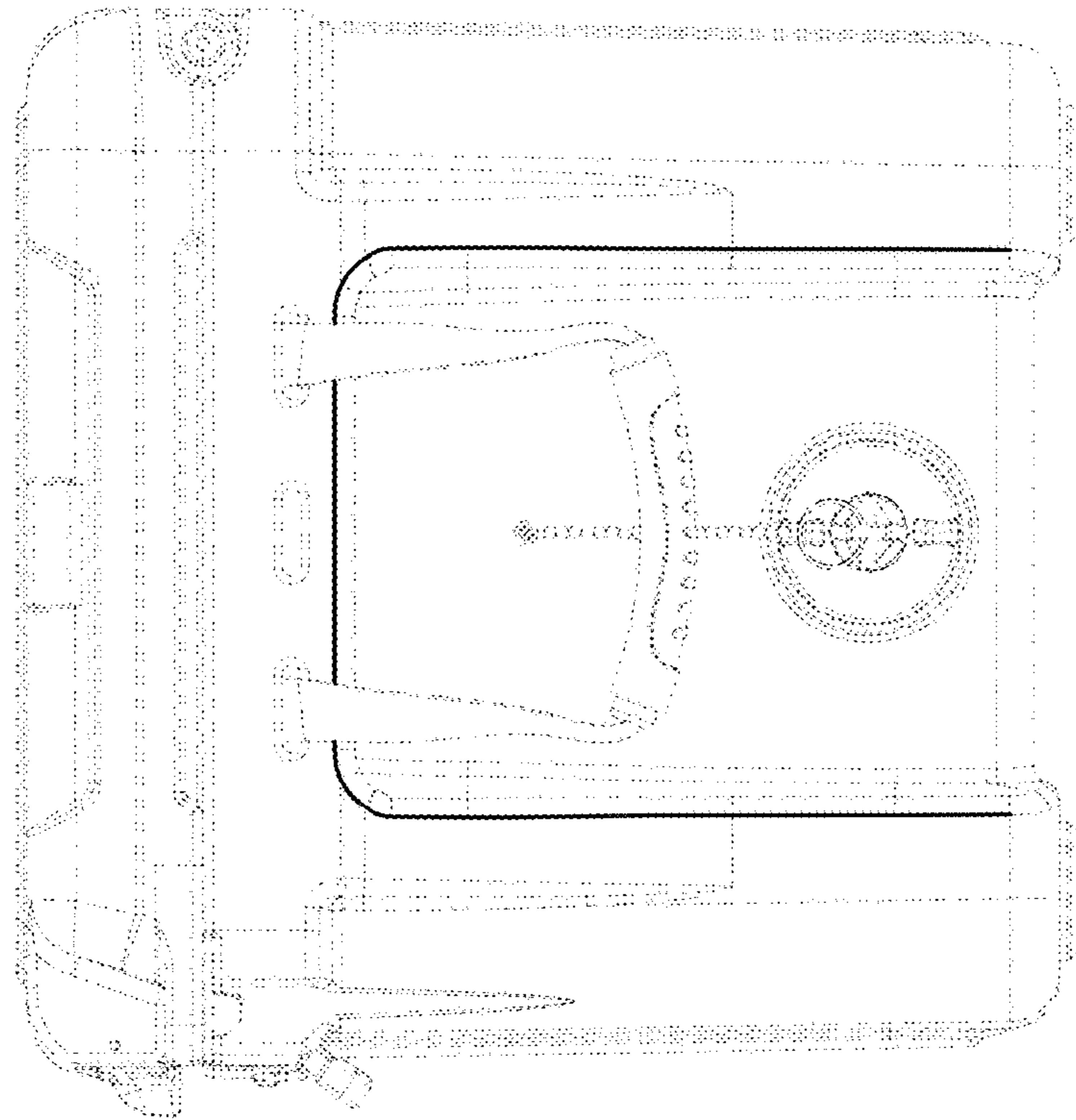

Figure 5

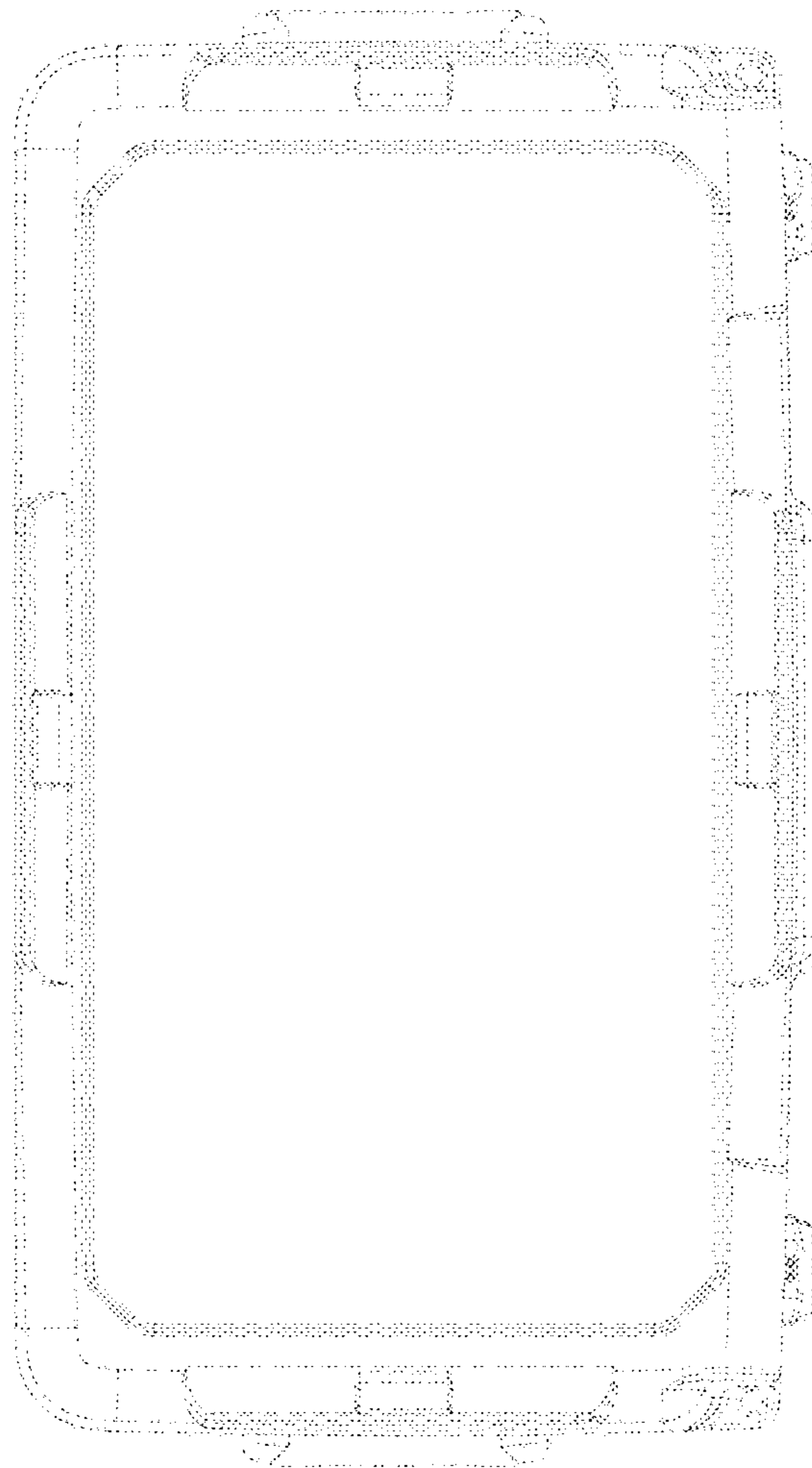

Figure 6

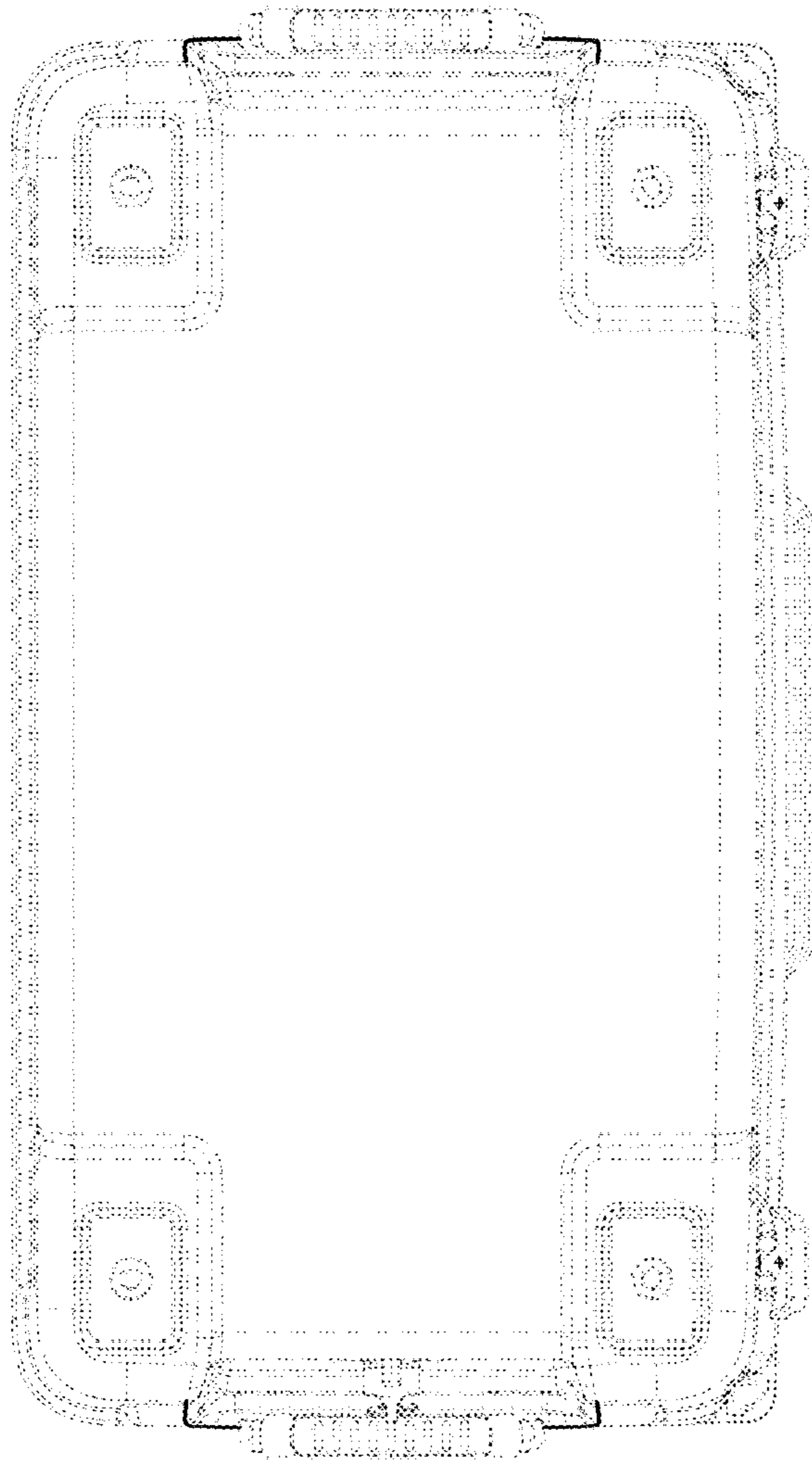

Figure 7

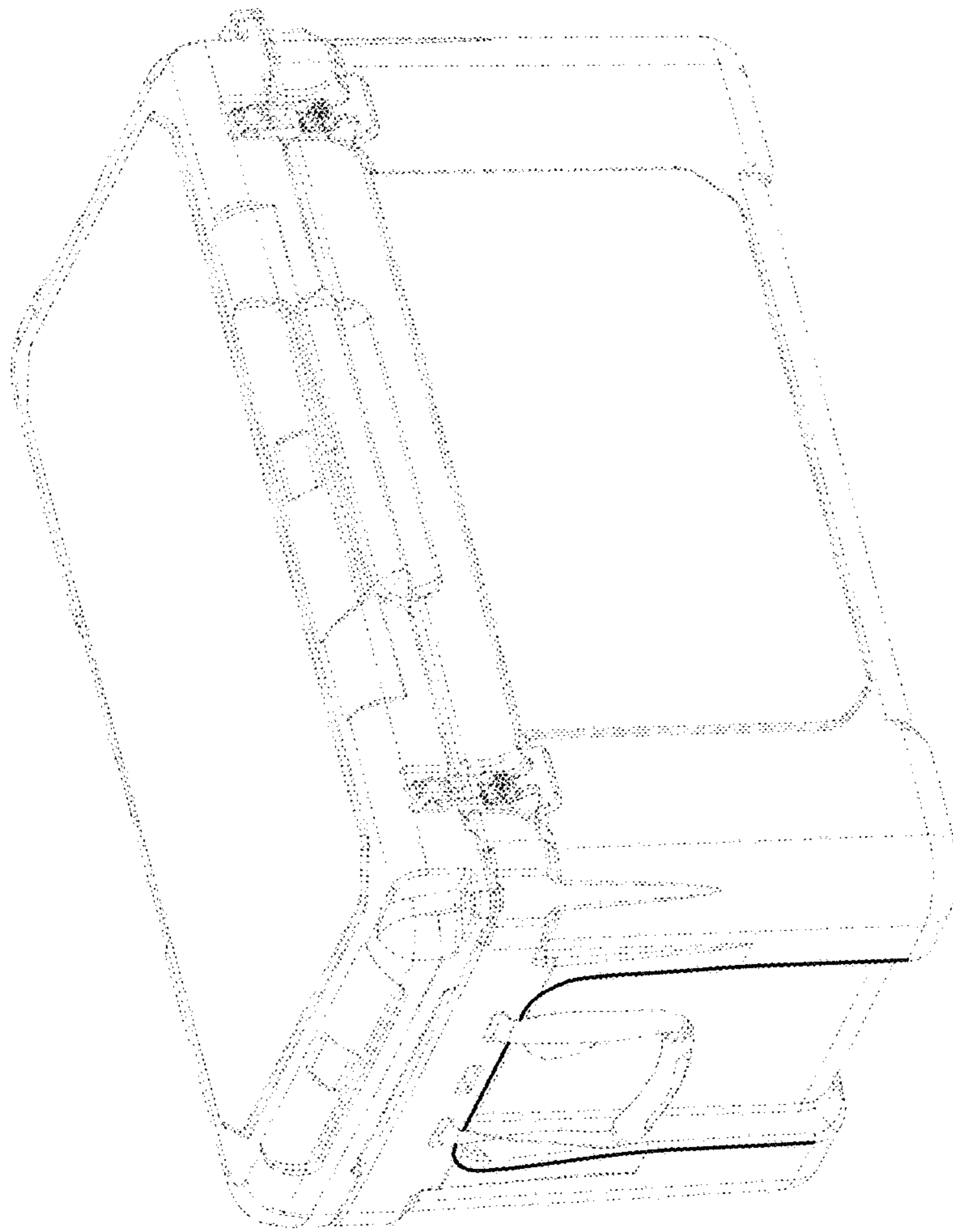

Figure 8

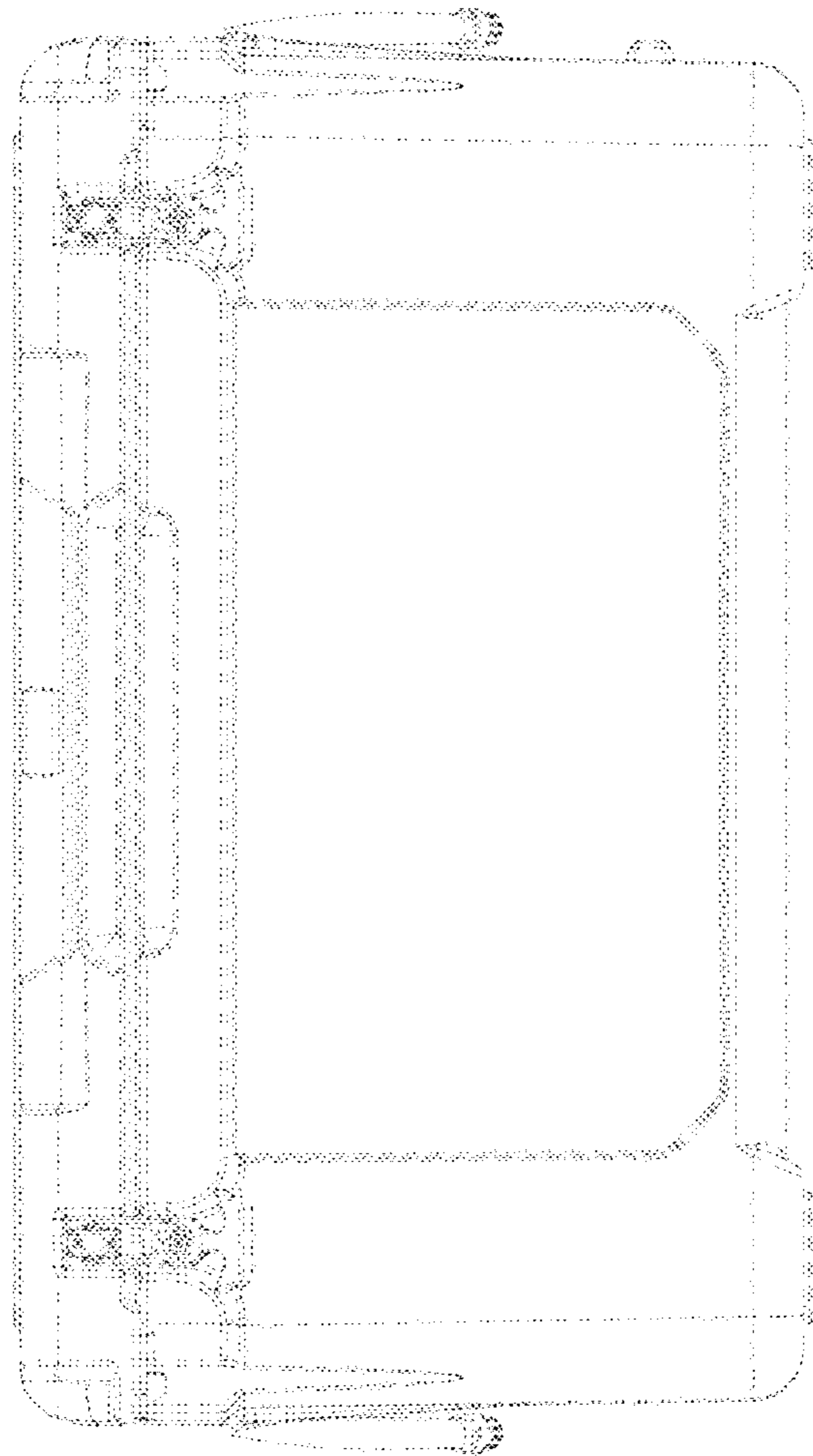

Figure 9

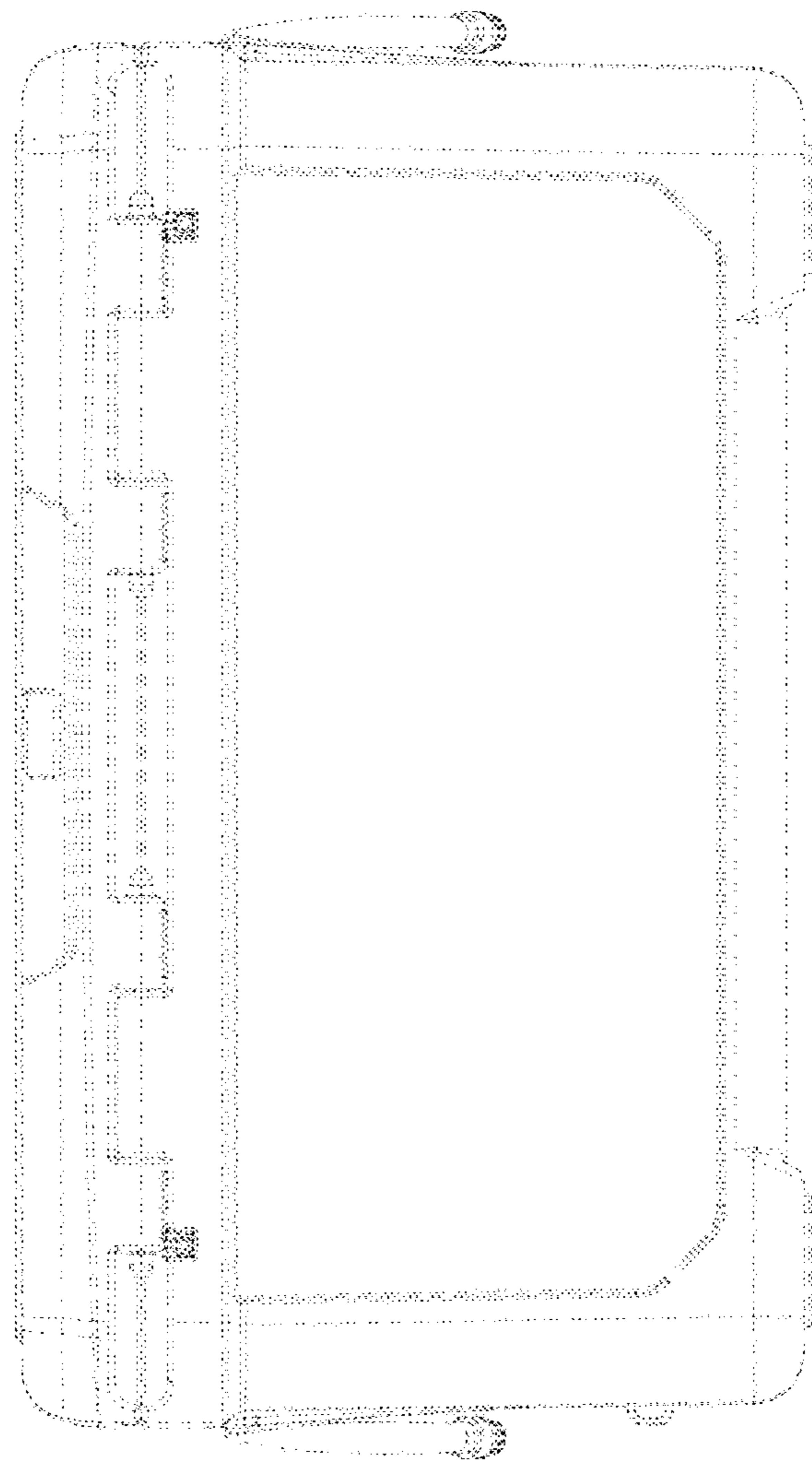

Figure 10

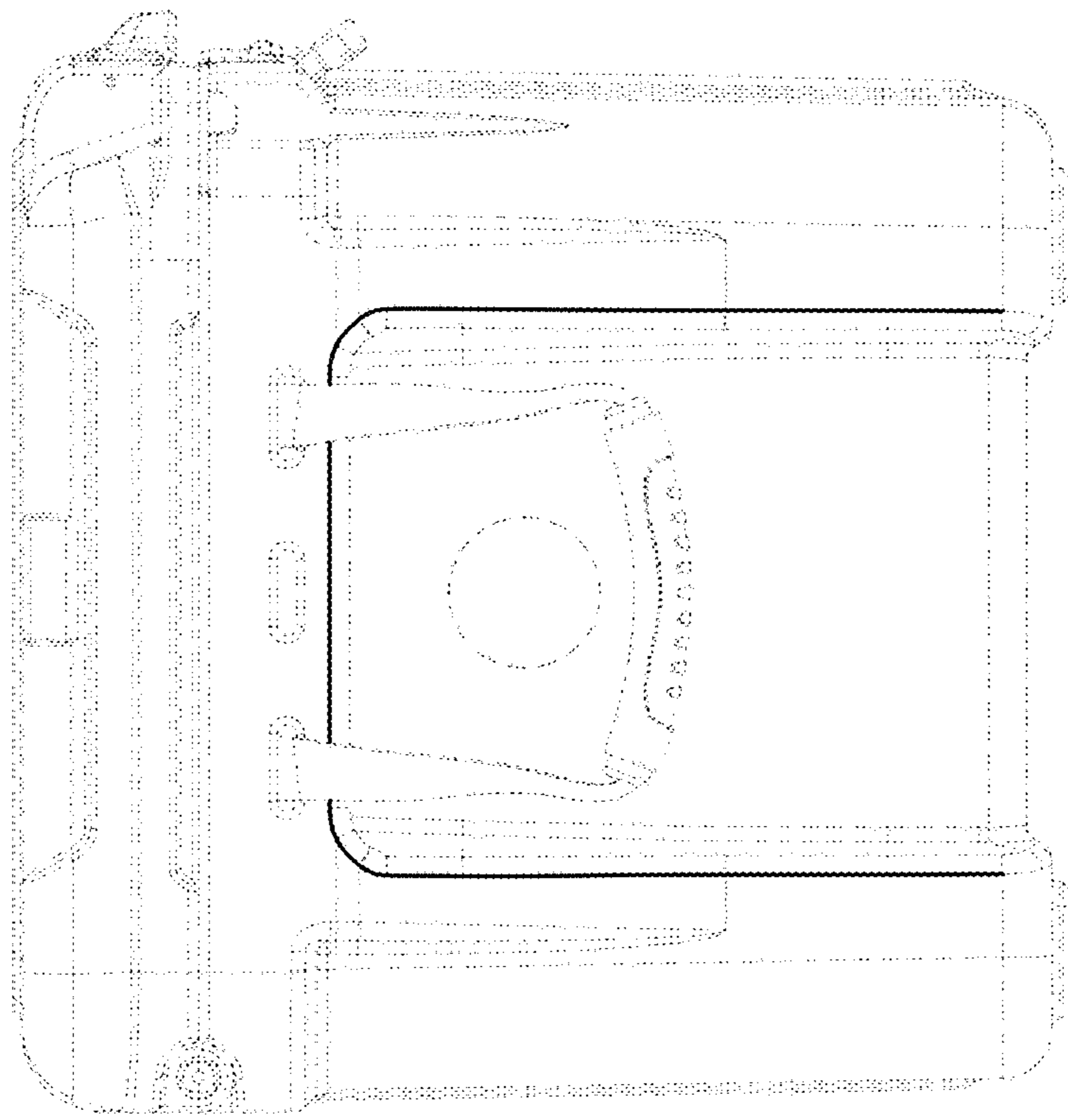

Figure 11

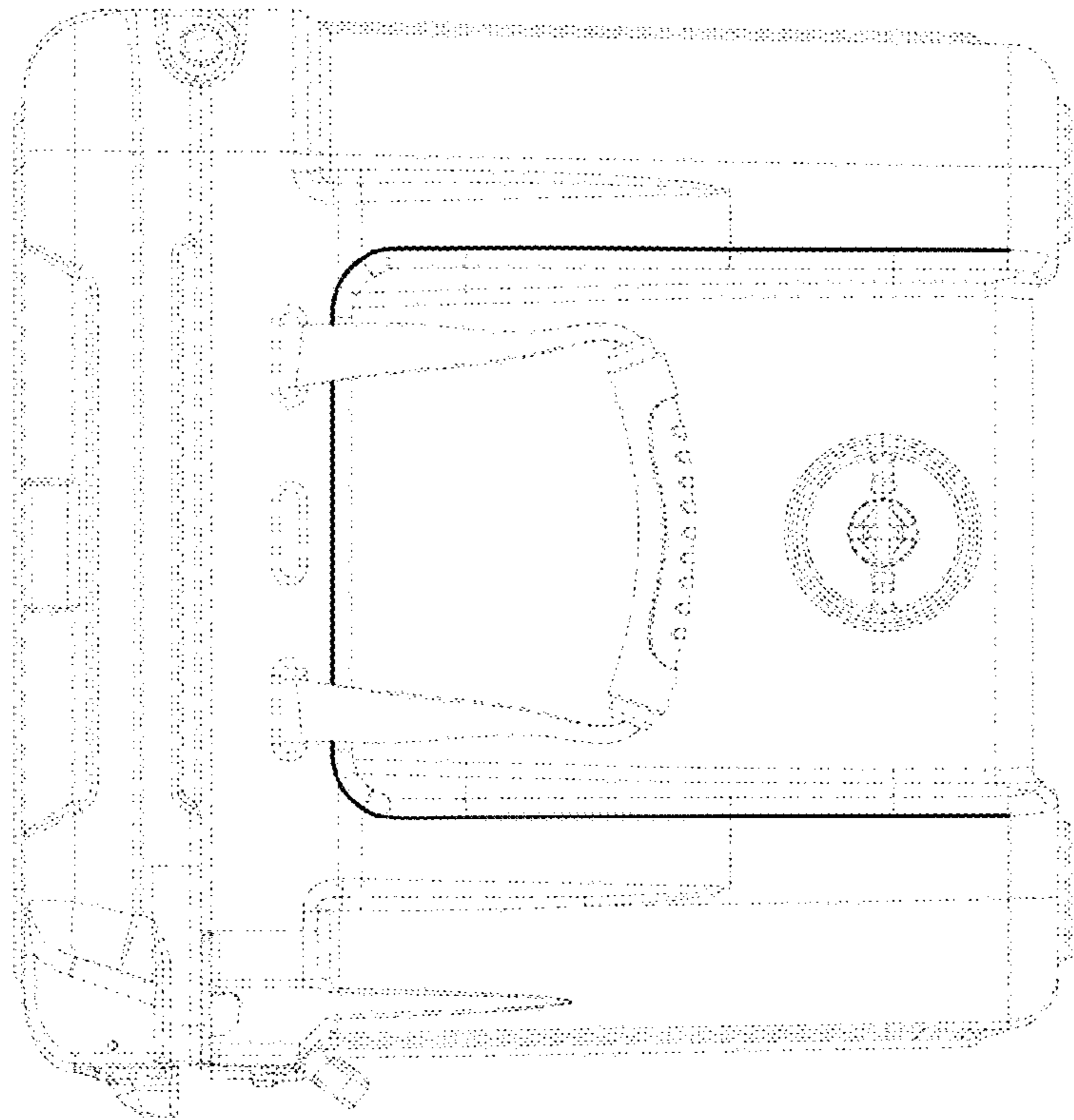

Figure 12

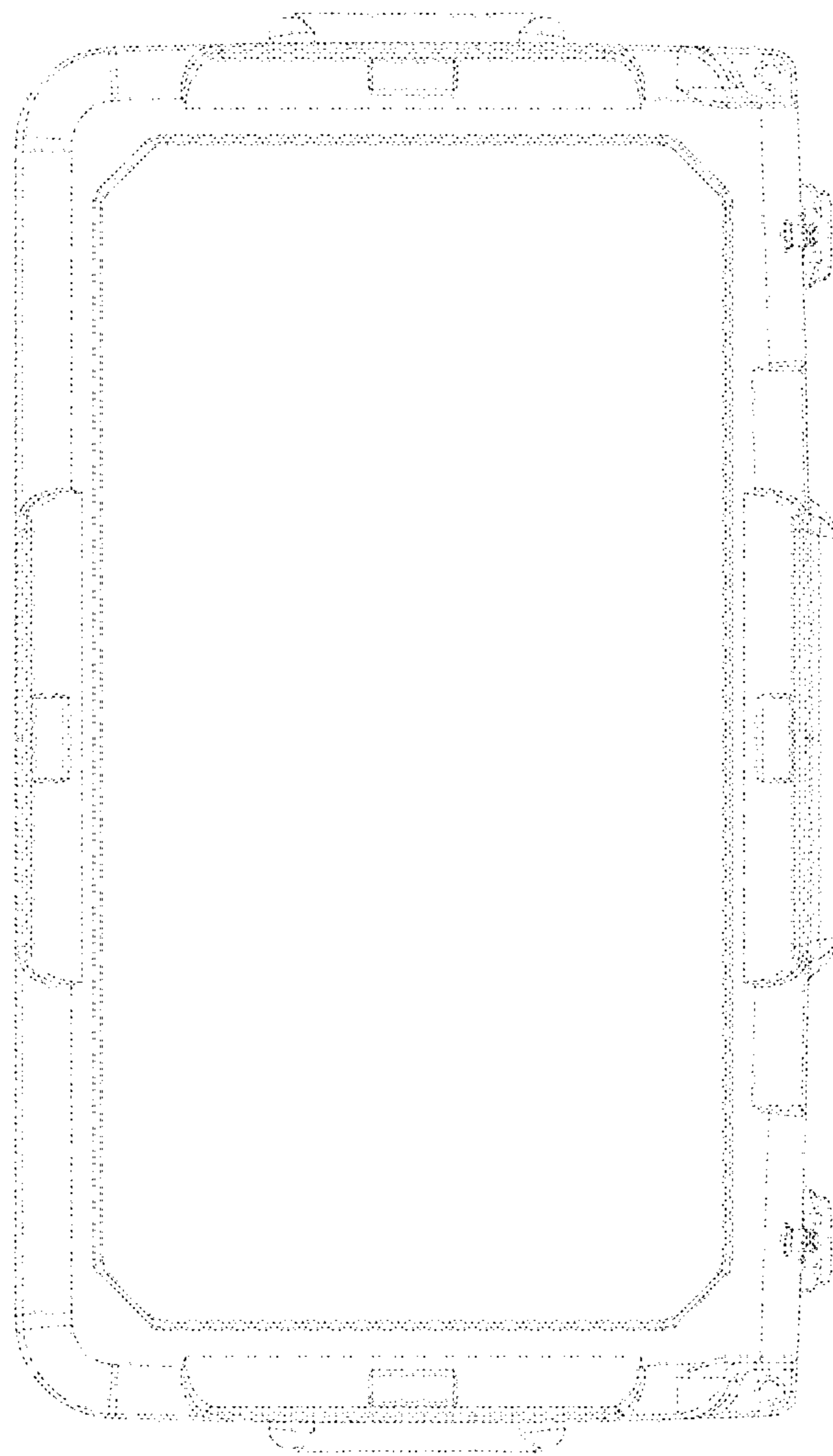

Figure 13

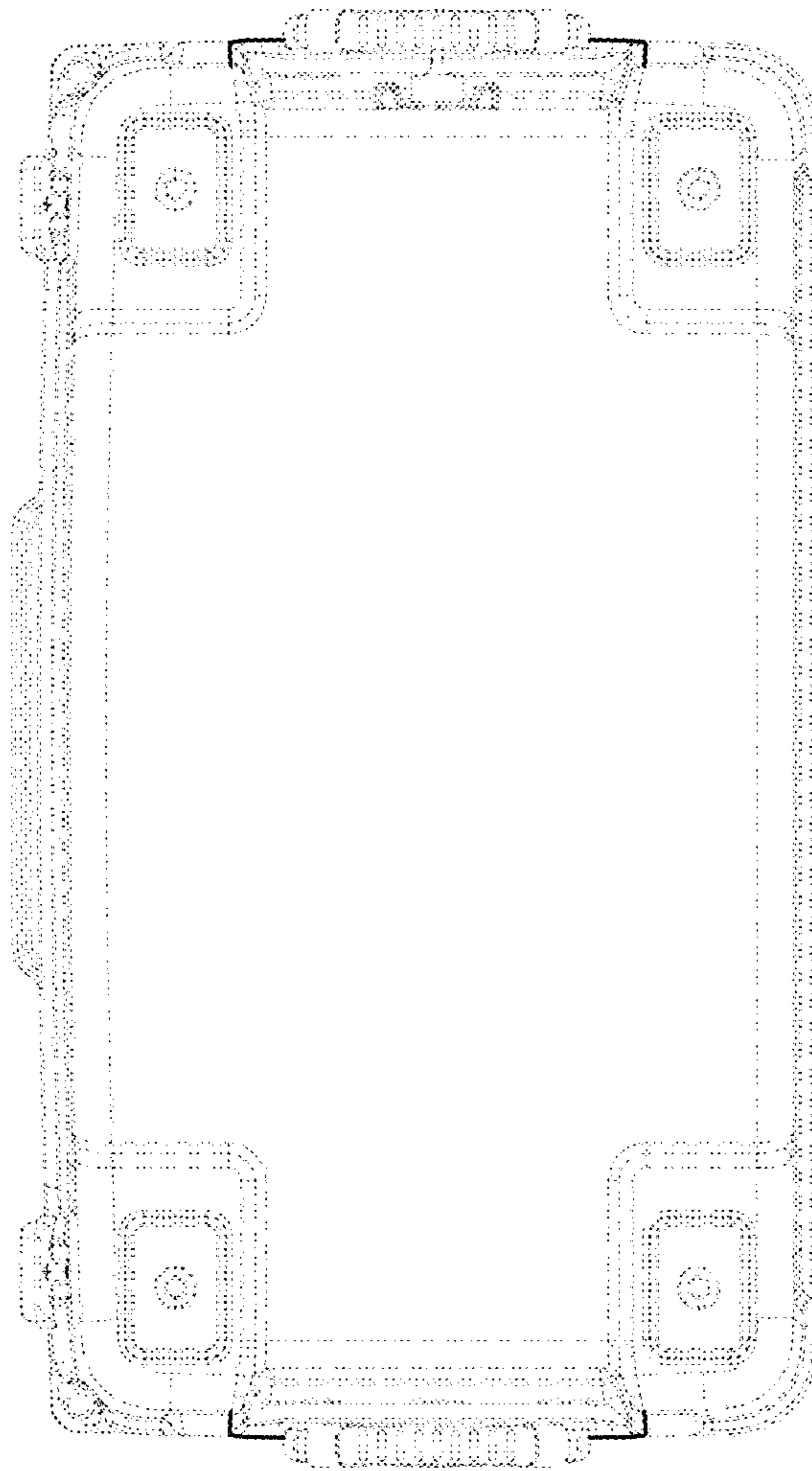

Figure 14

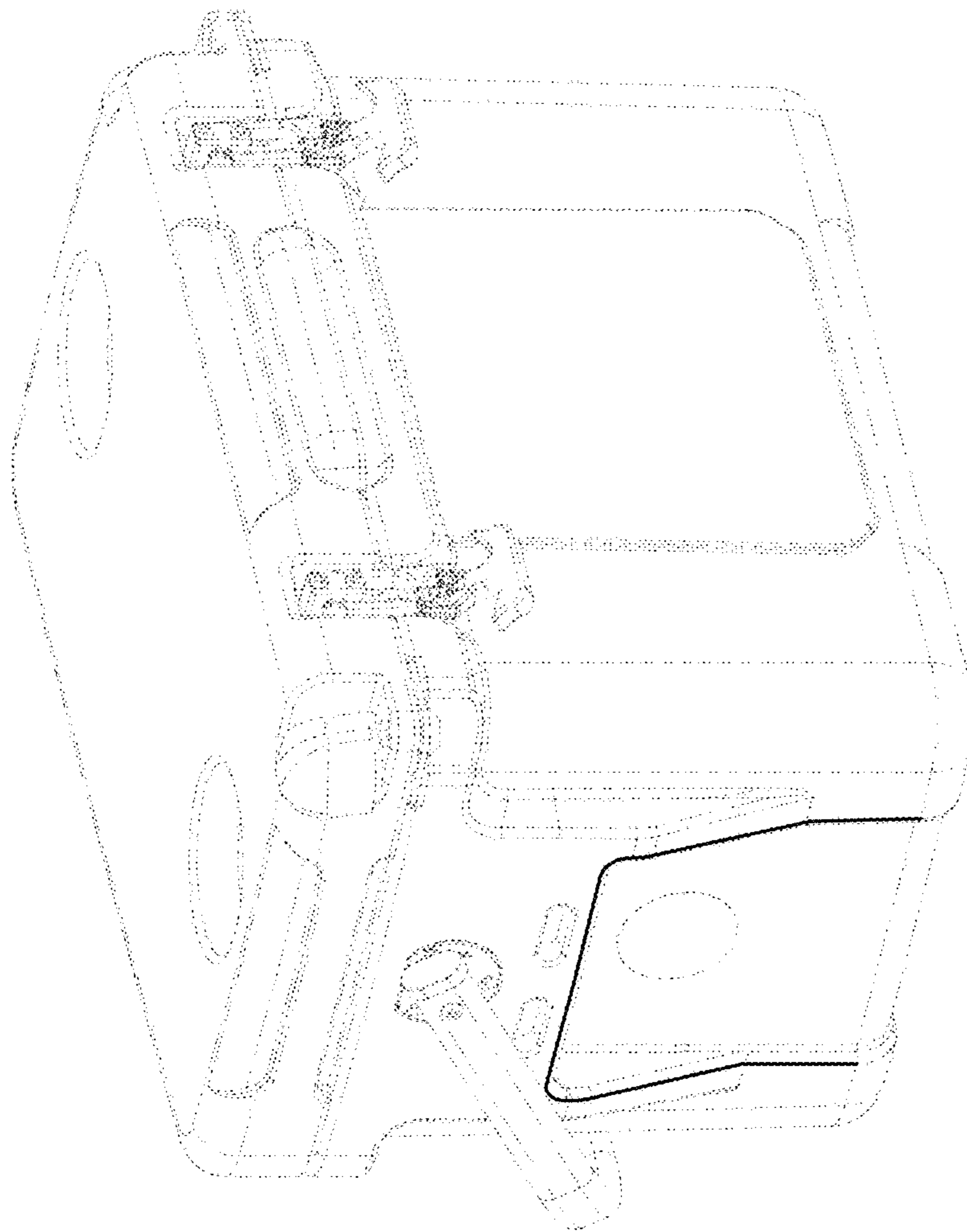

Figure 15

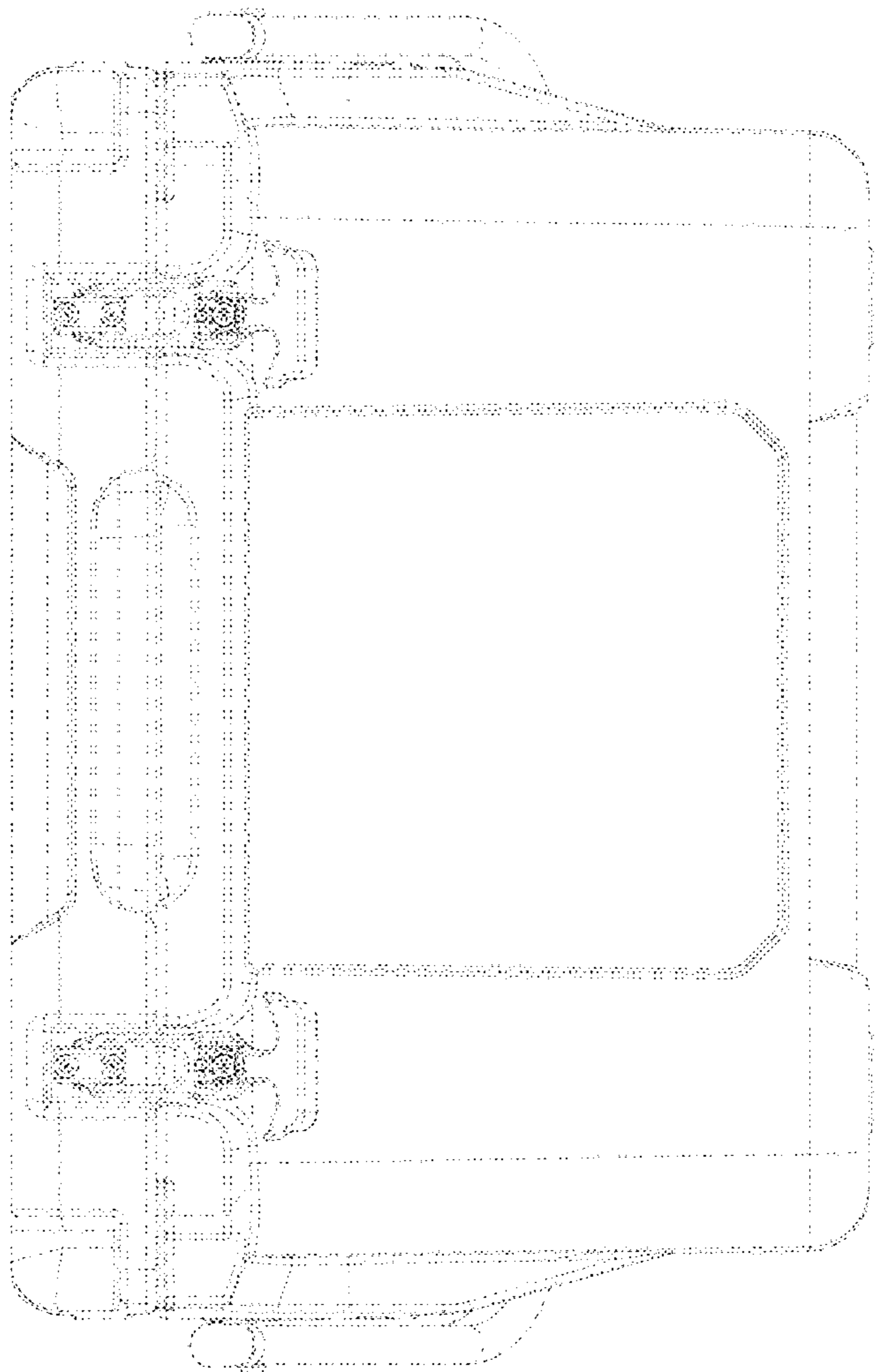

Figure 16

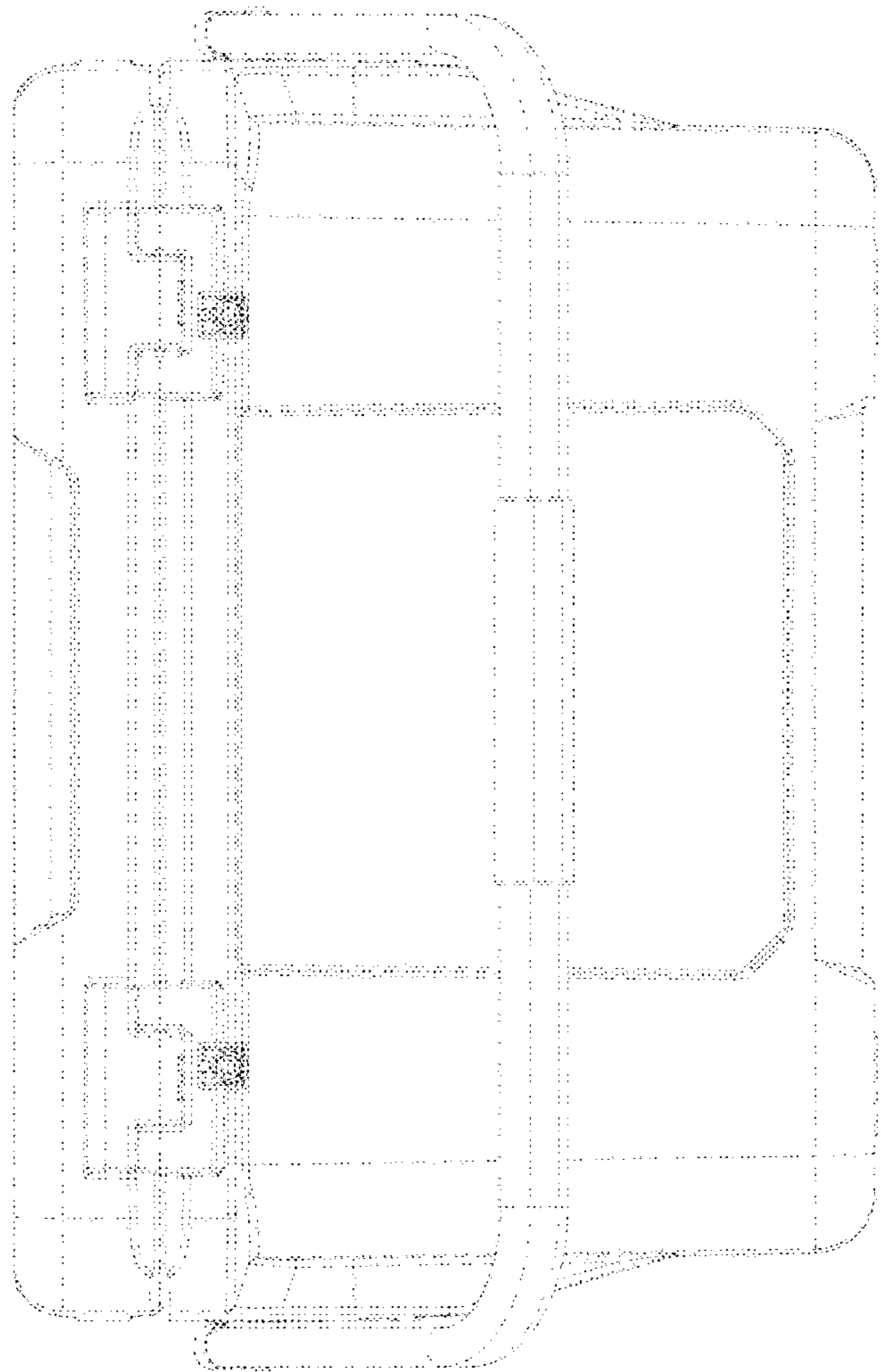

Figure 17

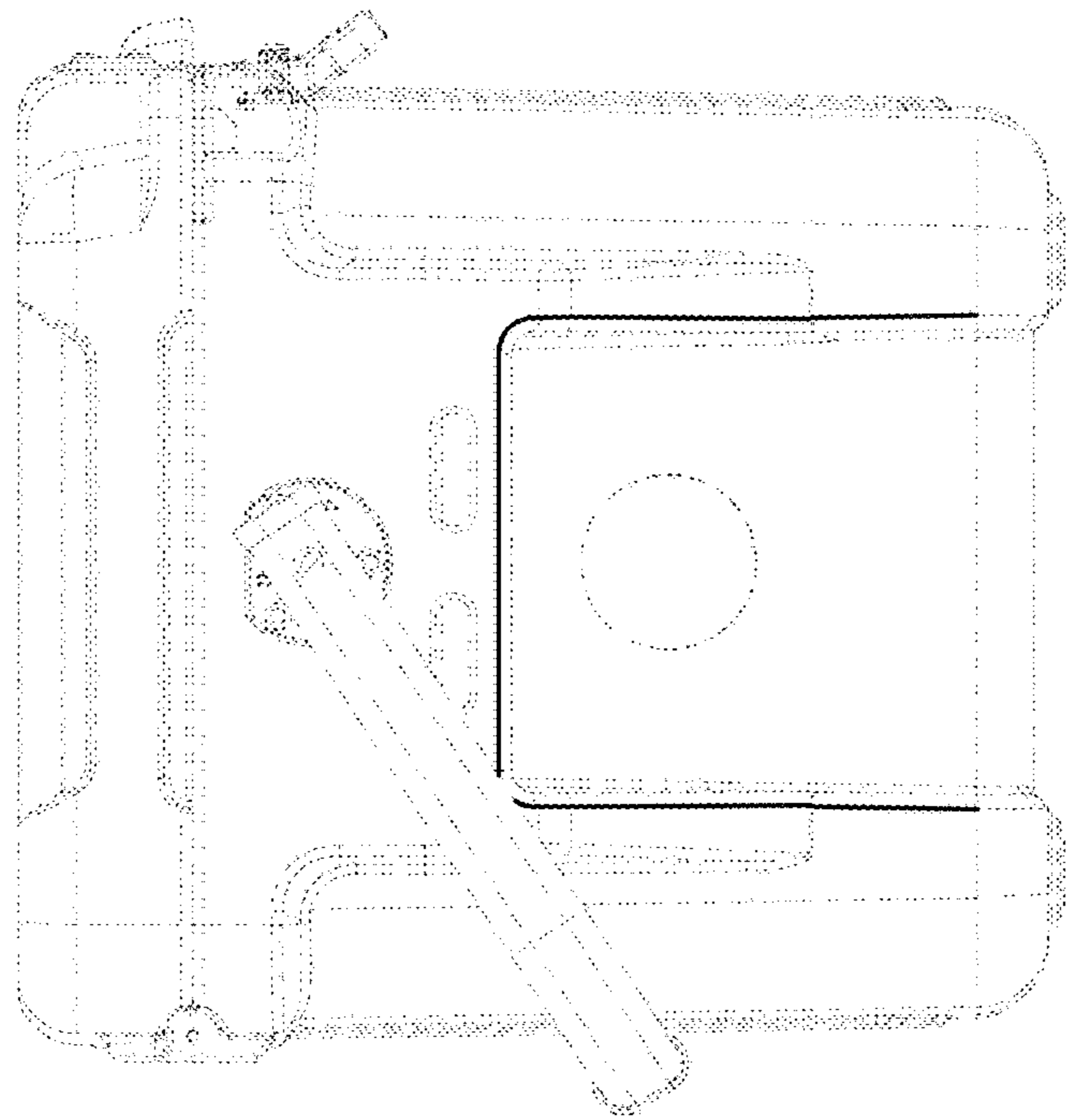

Figure 18

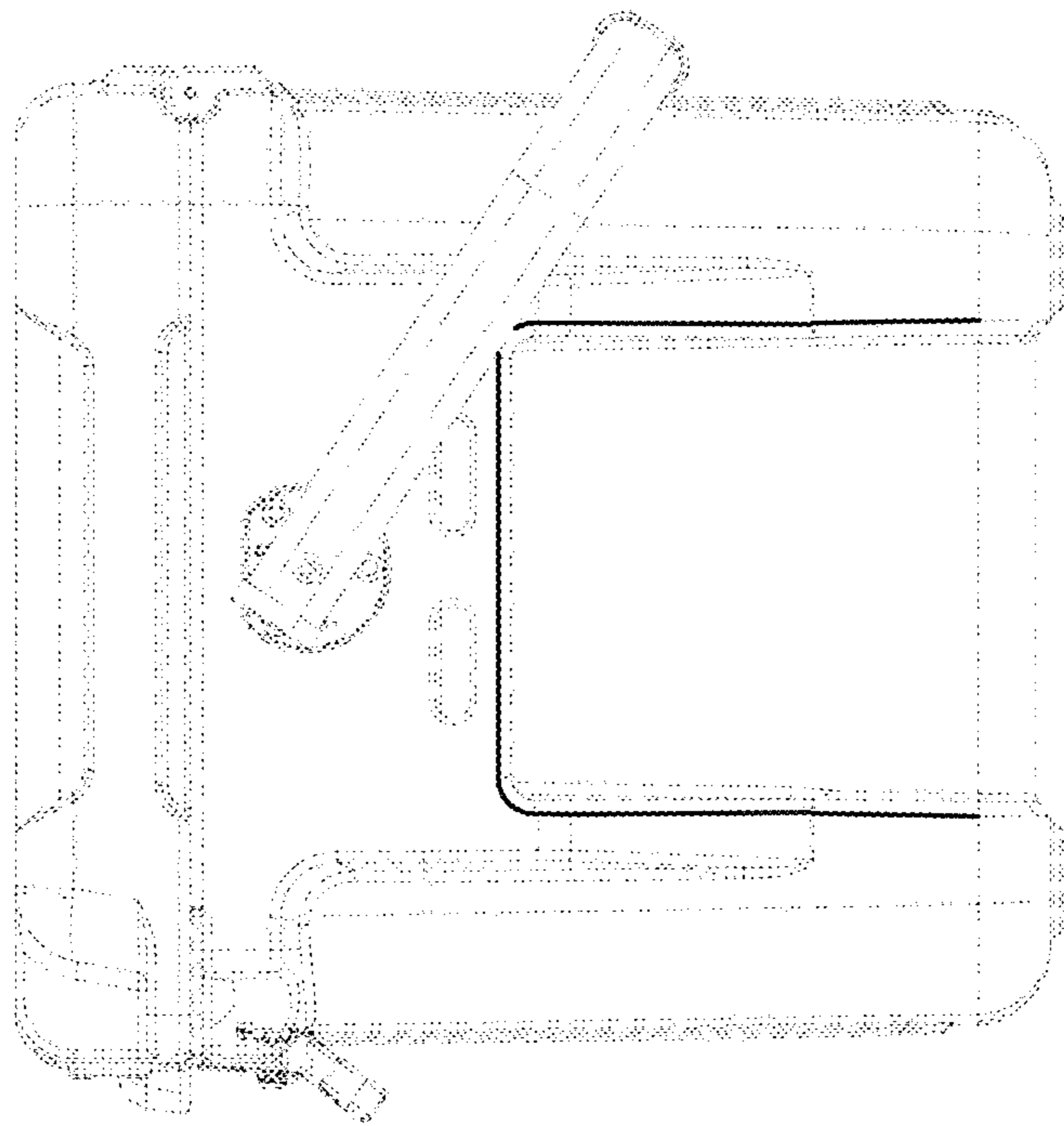

Figure 19

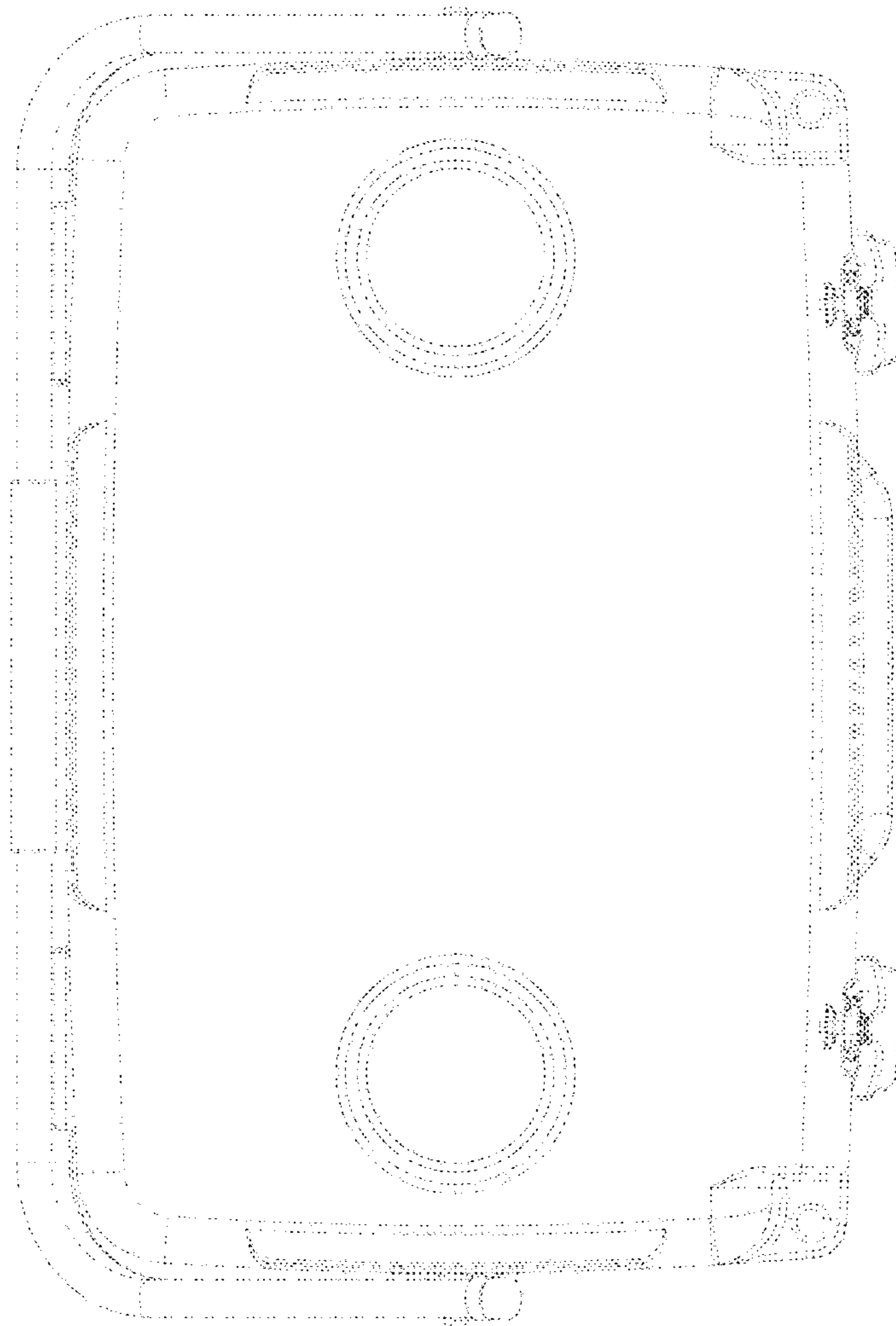

Figure 20

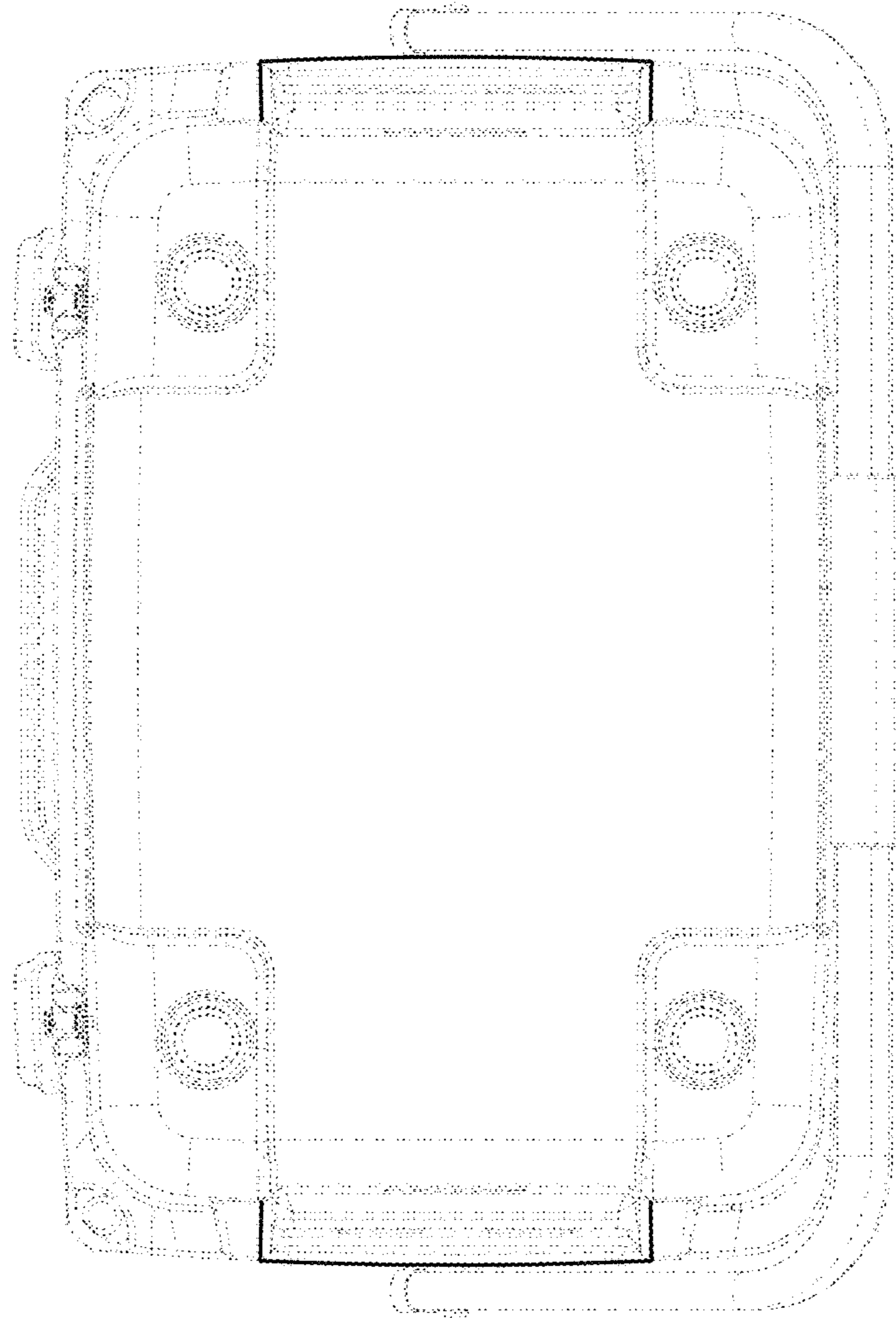

Figure 21