

US00D866099S

(12) **United States Design Patent** (10) **Patent No.:** **US D866,099 S**
Yoon et al. (45) **Date of Patent:** **** Nov. 5, 2019**

(54) **WASHING MACHINE**
(71) Applicant: **SAMSUNG ELECTRONICS CO., LTD.**, Suwon-si, Gyeonggi-do (KR)
(72) Inventors: **Sanghun Yoon**, Seoul (KR); **Yuna Park**, Seoul (KR); **Myunggyu Kim**, Seoul (KR); **Ahjung Joo**, Seoul (KR)
(73) Assignee: **SAMSUNG ELECTRONICS CO., LTD.**, Gyeonggi-Do (KR)
(**) Term: **15 Years**

D359,602 S 6/1995 Swartz et al.
D360,500 S 7/1995 Millet et al.
D374,954 S 10/1996 Katz et al.
D380,883 S 7/1997 Katz et al.
D457,991 S 5/2002 Baldwin et al.
D465,308 S 11/2002 Resuello et al.
D470,632 S 2/2003 Oda
D489,496 S 5/2004 Sneddon
D491,324 S 6/2004 Kim et al.
D492,073 S 6/2004 Sneddon
D516,258 S 2/2006 Matsusaki et al.
D517,257 S 3/2006 Kim et al.
D519,692 S 4/2006 Jun
D524,000 S 6/2006 Kim et al.

(Continued)

(21) Appl. No.: **29/683,753**
(22) Filed: **Mar. 15, 2019**

Related U.S. Application Data

(63) Continuation of application No. 29/656,104, filed on Jul. 10, 2018, now Pat. No. Des. 848,092, which is a continuation of application No. 29/590,829, filed on Jan. 13, 2017, now Pat. No. Des. 826,489.

(30) **Foreign Application Priority Data**

Nov. 29, 2016 (KR) 30-2016-0057634

(51) **LOC (12) Cl.** **15-05**

(52) **U.S. Cl.**
USPC **D32/6**

(58) **Field of Classification Search**
USPC D32/1, 5, 6, 8, 12, 25, 28, 29
CPC D06F 33/02; D06F 39/02; D06F 2204/065;
D06F 25/00; D06F 35/006; D06F 58/00;
D06F 58/02; D06F 58/04; D06F 58/20;
D06F 23/04; G05B 19/042

See application file for complete search history.

(56) **References Cited**

U.S. PATENT DOCUMENTS

4,307,588 A 12/1981 Smith et al.
4,429,817 A 2/1984 Ikeda

FOREIGN PATENT DOCUMENTS

CN 303423821 S 10/2015
KR 300387514 S 7/2005
KR 300768037 S 11/2014

Primary Examiner — Michelle E. Wilson

(74) *Attorney, Agent, or Firm* — Cantor Colburn LLP

(57) **CLAIM**

We claim the ornamental design for a washing machine, as shown and described.

DESCRIPTION

FIG. 1 is the front perspective view of a washing machine showing our new design;
FIG. 2 is the front view thereof;
FIG. 3 is the rear view thereof;
FIG. 4 is the left-side view thereof;
FIG. 5 is the right-side view thereof;
FIG. 6 is the top view thereof; and,
FIG. 7 is the bottom view thereof.
The broken lines in the figures depict environmental subject matter and form no part of the claimed design.

1 Claim, 7 Drawing Sheets

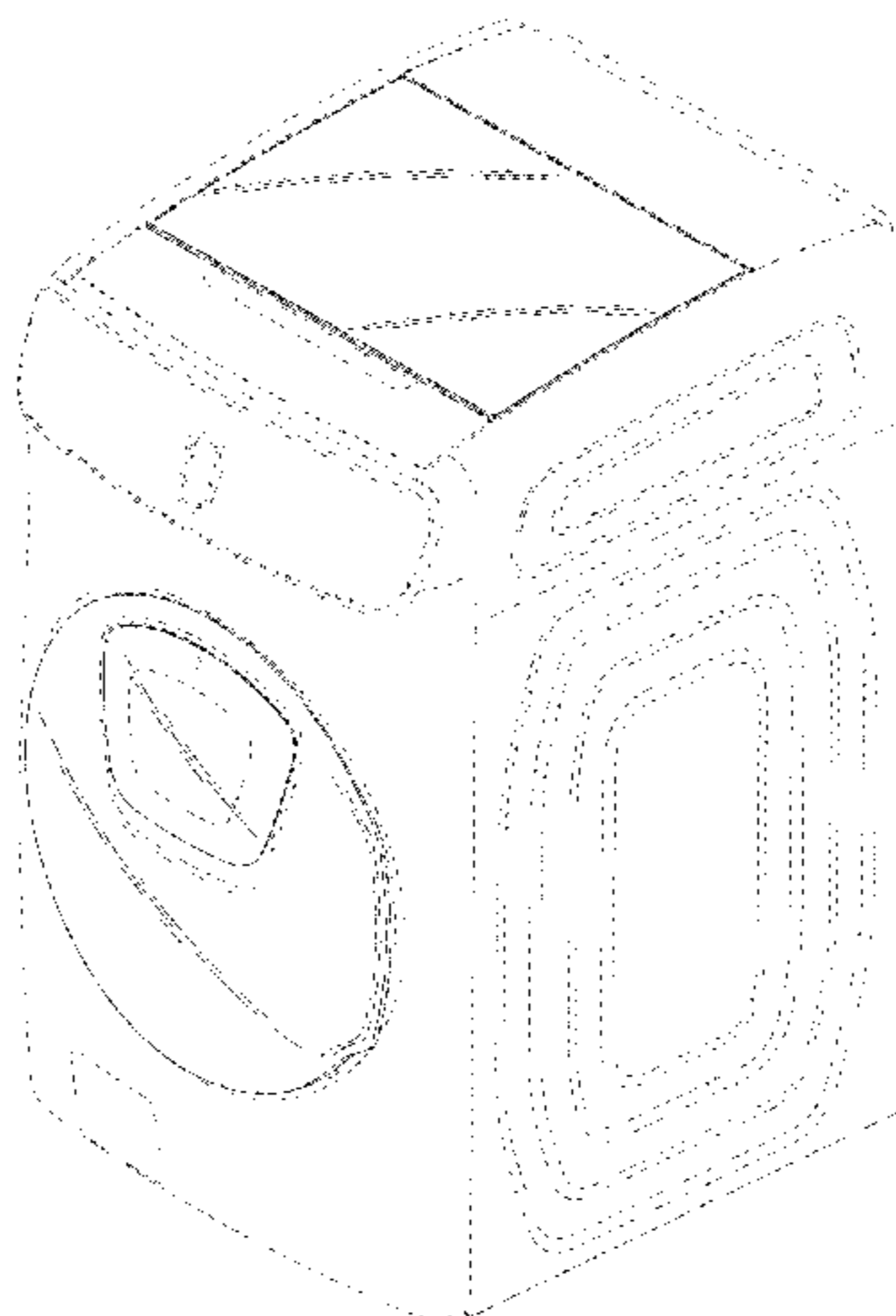

(56)

References Cited

U.S. PATENT DOCUMENTS

D526,453 S	8/2006	Jun	D733,372 S	6/2015	Song et al.
D527,150 S	8/2006	Jun	D739,096 S	9/2015	Qin et al.
D527,853 S	9/2006	Carey et al.	D739,097 S	9/2015	Qin et al.
D528,712 S	9/2006	Ha et al.	D742,602 S	11/2015	Kim
D528,713 S	9/2006	Ha et al.	D746,521 S	12/2015	Ha et al.
D532,941 S	11/2006	Carey et al.	D747,836 S	1/2016	Cho et al.
D536,144 S	1/2007	Seo et al.	D748,355 S	1/2016	Sim et al.
D538,488 S	3/2007	Carey et al.	D752,830 S	3/2016	Choi et al.
D542,487 S	5/2007	Jun	D759,325 S	6/2016	Jeon et al.
D542,986 S	5/2007	Crookshanks	D759,909 S	6/2016	Kim et al.
D542,987 S	5/2007	Crookshanks	D759,912 S	6/2016	Bixby et al.
D554,307 S	10/2007	Kim	D760,454 S	6/2016	Joo et al.
D556,394 S	11/2007	Kim	D761,503 S	7/2016	Choi et al.
D571,964 S	6/2008	Kim	D762,021 S	7/2016	Qin et al.
D575,012 S	8/2008	Rossetto et al.	D762,025 S	7/2016	Joo et al.
D575,464 S	8/2008	Rossetto et al.	D762,027 S	7/2016	Choi et al.
D575,913 S	8/2008	Jeon et al.	D764,120 S	8/2016	Choi et al.
D577,162 S	9/2008	Shail et al.	D764,121 S	8/2016	Choi et al.
D588,757 S	3/2009	Park et al.	D764,122 S	8/2016	Jo
D597,712 S	8/2009	Jeon et al.	D764,123 S	8/2016	Kim et al.
D617,960 S	6/2010	Bohm et al.	D764,123 S	8/2016	Kim et al.
D620,650 S	7/2010	Lee	D764,722 S	8/2016	Jo
D625,476 S	10/2010	Lee et al.	D769,553 S	10/2016	Lee
D626,299 S	10/2010	Lee et al.	D770,103 S	10/2016	Ha et al.
D630,807 S	1/2011	Song et al.	D770,698 S	11/2016	Lee et al.
D631,215 S	1/2011	Song et al.	D770,705 S	11/2016	Kang et al.
D631,624 S	1/2011	Chung et al.	D770,706 S	11/2016	Ha et al.
D632,033 S	2/2011	Song et al.	D770,707 S	11/2016	Ha et al.
D633,261 S	2/2011	Song et al.	D771,330 S	11/2016	Ha et al.
D642,752 S	8/2011	Kim	D772,499 S	11/2016	Yoon et al.
D642,753 S	8/2011	Ha	D772,500 S	11/2016	Park et al.
D648,084 S	11/2011	Browne et al.	D772,502 S	11/2016	Choi et al.
D648,085 S	11/2011	Miller et al.	D773,128 S	11/2016	Kim et al.
D648,497 S	11/2011	Bhattacharya	D773,753 S	12/2016	Kim et al.
D648,907 S	11/2011	Jeon et al.	D773,754 S	12/2016	Choi et al.
D649,722 S	11/2011	Chung et al.	D773,755 S	12/2016	Hwang et al.
D653,006 S	1/2012	Takahashi	D773,757 S	12/2016	Hwang et al.
D654,640 S	2/2012	Song et al.	D774,714 S	12/2016	Kang et al.
D658,340 S	4/2012	Jeon et al.	D774,715 S	12/2016	Kim et al.
D659,307 S	5/2012	Geyer et al.	D774,716 S	12/2016	Kim
D661,852 S	6/2012	Song et al.	D787,759 S	5/2017	Geyer et al.
D663,907 S	7/2012	Jeon et al.	D795,512 S	8/2017	Joo et al.
D665,544 S	8/2012	Jeon et al.	D796,752 S	9/2017	Bixby et al.
D667,179 S	9/2012	Jeon et al.	D798,004 S	9/2017	Bixby et al.
D679,462 S	4/2013	Zhang et al.	D800,976 S	10/2017	Im et al.
D693,973 S	11/2013	Geyer et al.	D801,602 S	10/2017	Im et al.
D694,965 S	12/2013	Lee et al.	D812,325 S	3/2018	Bixby et al.
D695,474 S	12/2013	Calmeise	D824,607 S	7/2018	Bixby et al.
D697,680 S	1/2014	Hwang et al.	D825,867 S	* 8/2018	Yoon D32/6
D699,907 S	2/2014	Choi et al.	D825,871 S	* 8/2018	Kim D32/28
D701,656 S	3/2014	Choi et al.	D826,489 S	* 8/2018	Yoon D32/6
D701,657 S	3/2014	Chung et al.	D831,906 S	* 10/2018	Lidija D32/6
D701,658 S	3/2014	Chung et al.	D832,534 S	* 10/2018	Ha D32/6
D703,885 S	4/2014	Ha et al.	D833,091 S	11/2018	Ayers et al.
D703,886 S	4/2014	Ha et al.	D834,265 S	* 11/2018	Kim D32/6
D705,508 S	5/2014	Calmeise	D835,368 S	* 12/2018	Ha D32/6
D712,603 S	9/2014	Geyer et al.	D835,865 S	* 12/2018	Lee D32/6
D729,996 S	5/2015	Hwang et al.	D836,265 S	* 12/2018	Kim D32/6
D729,998 S	5/2015	Jeon et al.	D839,513 S	1/2019	Ayers et al.
D730,596 S	5/2015	Kim et al.	D841,905 S	* 2/2019	Kim D32/6
D732,763 S	6/2015	Hwang et al.	D843,670 S	* 3/2019	Yoon D32/6
D732,767 S	6/2015	Ha et al.	D848,092 S	* 5/2019	Yoon D32/6
			D850,033 S	* 5/2019	Yoon D32/6
			D850,034 S	* 5/2019	Yoon D32/6

* cited by examiner

FIG. 1

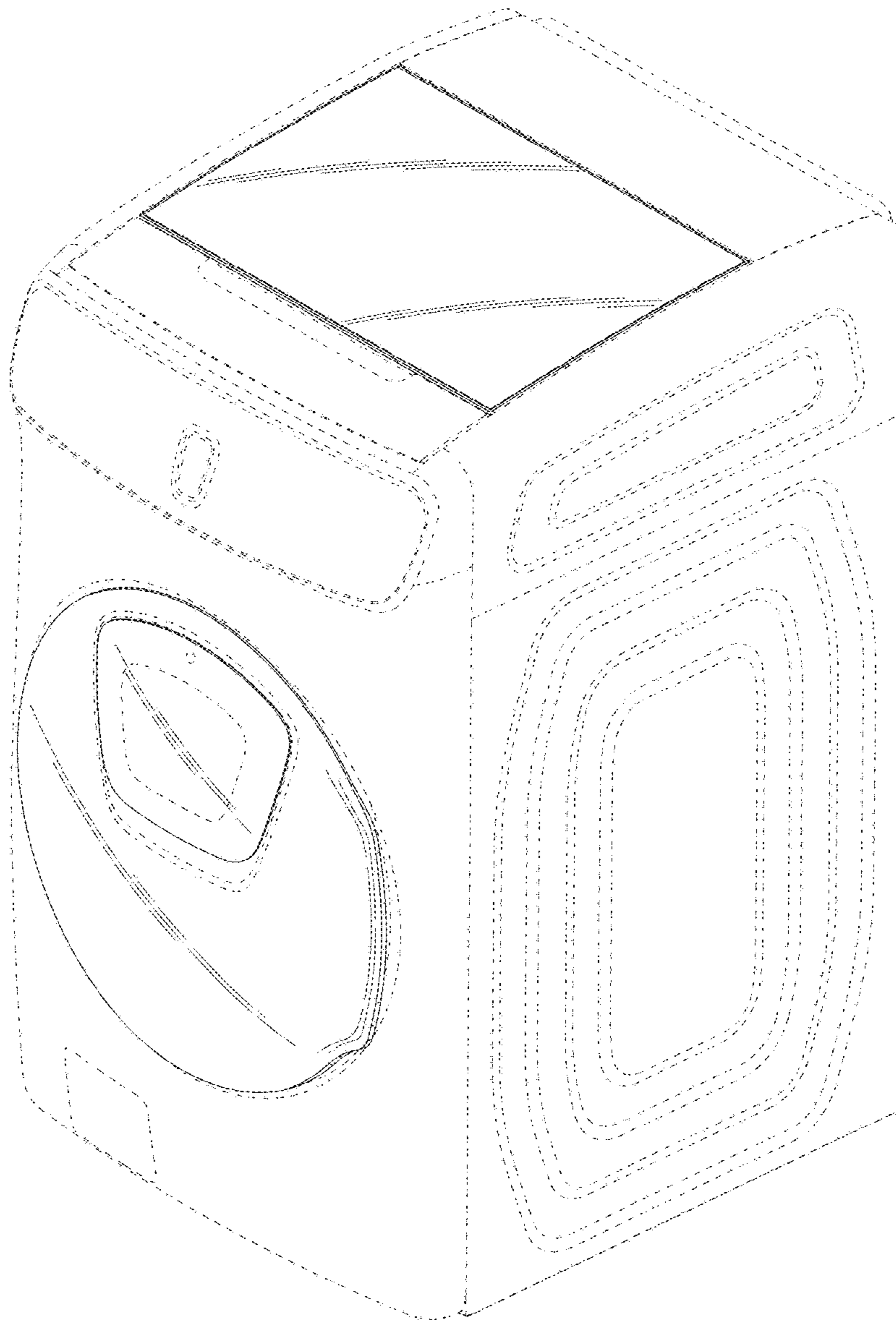

FIG. 2

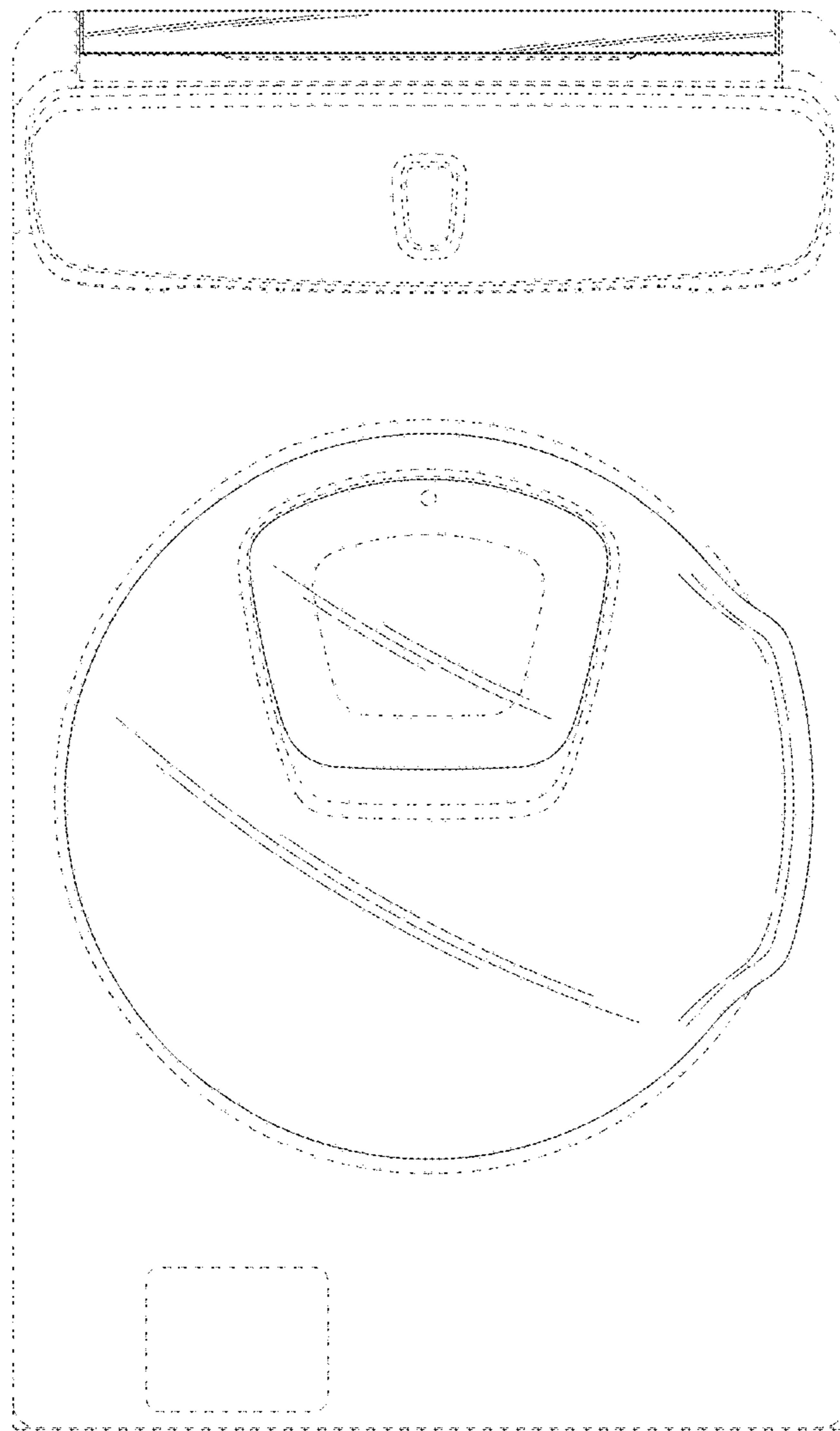

FIG. 3

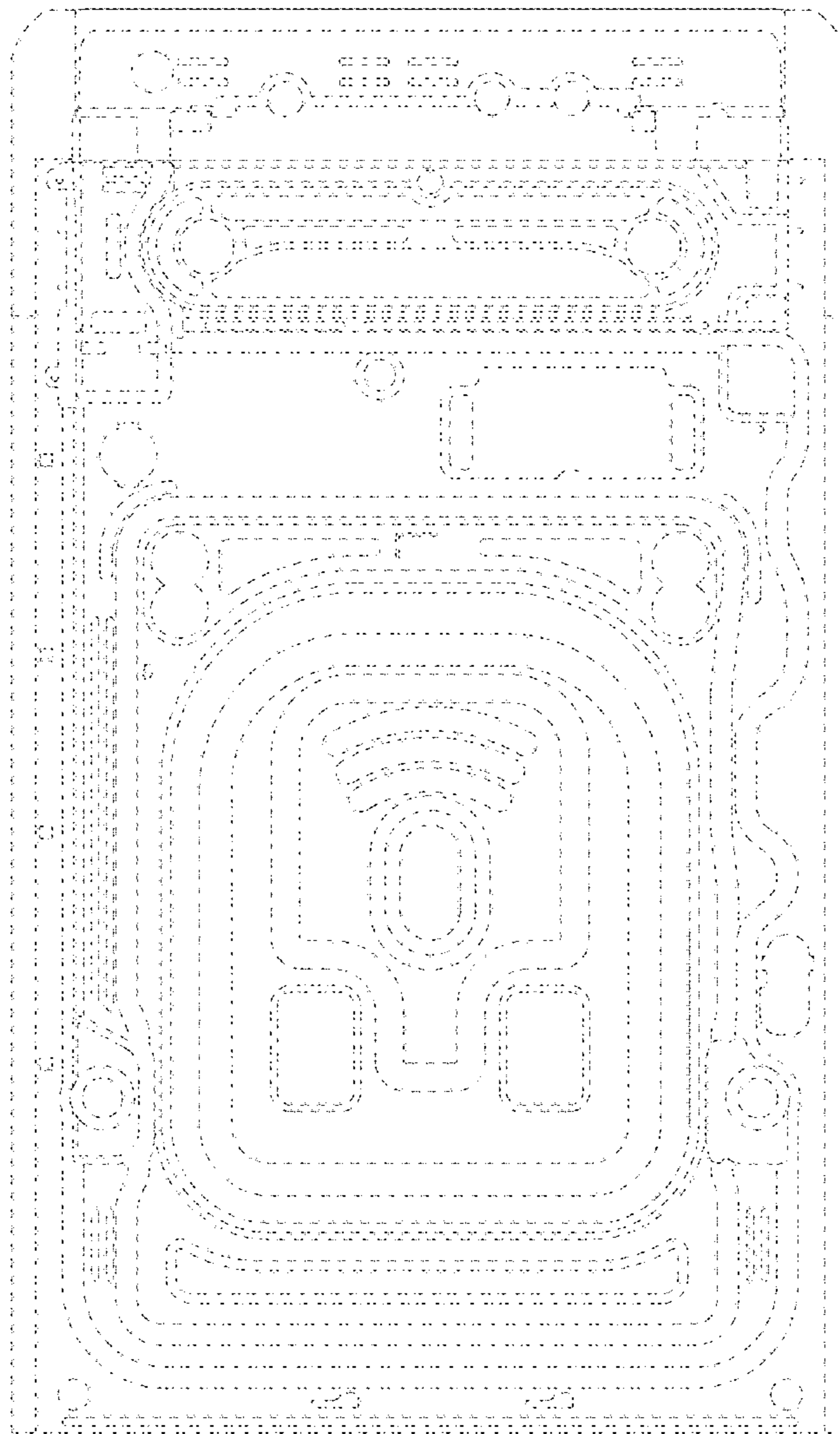

FIG. 4

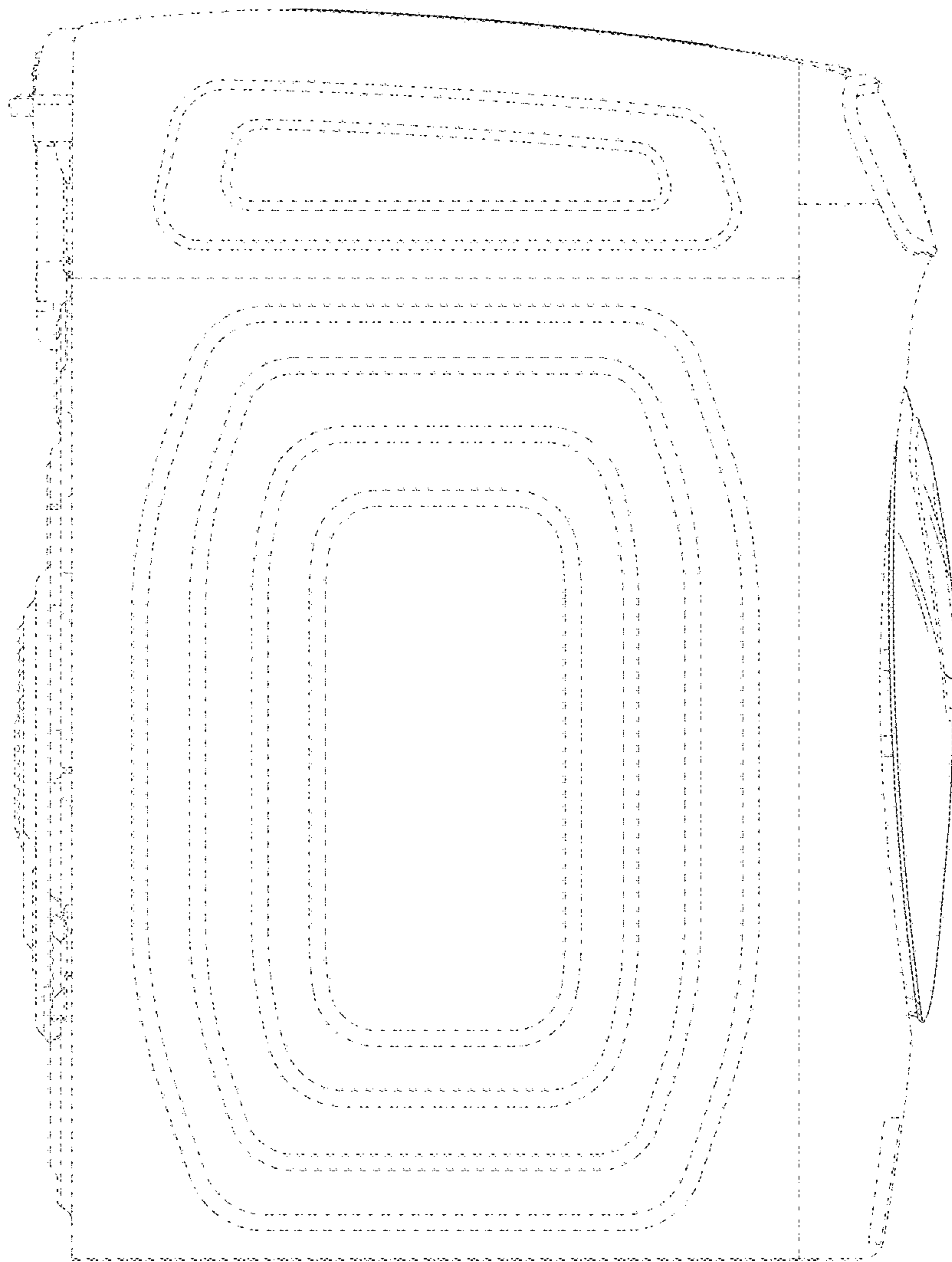

FIG. 5

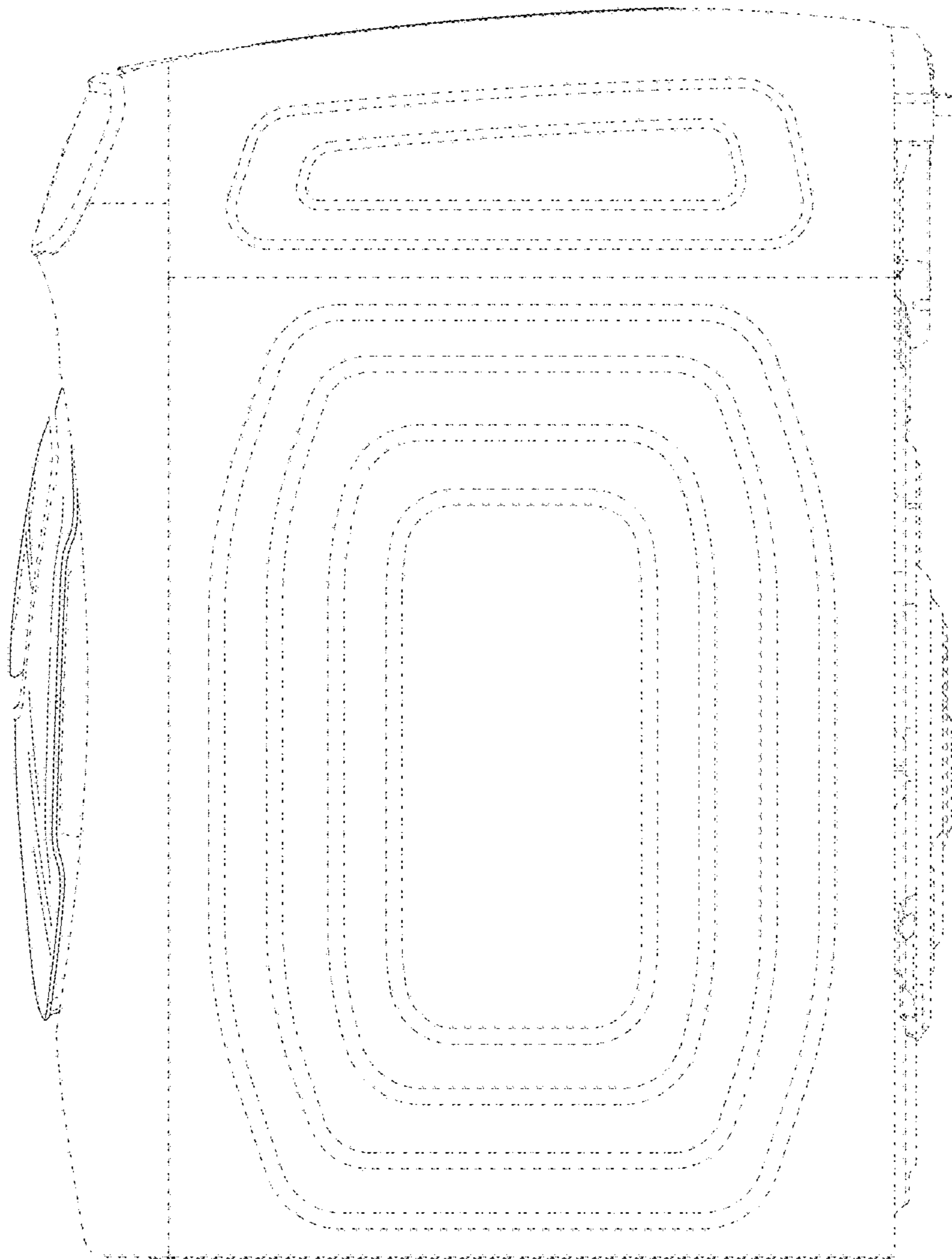

FIG. 6

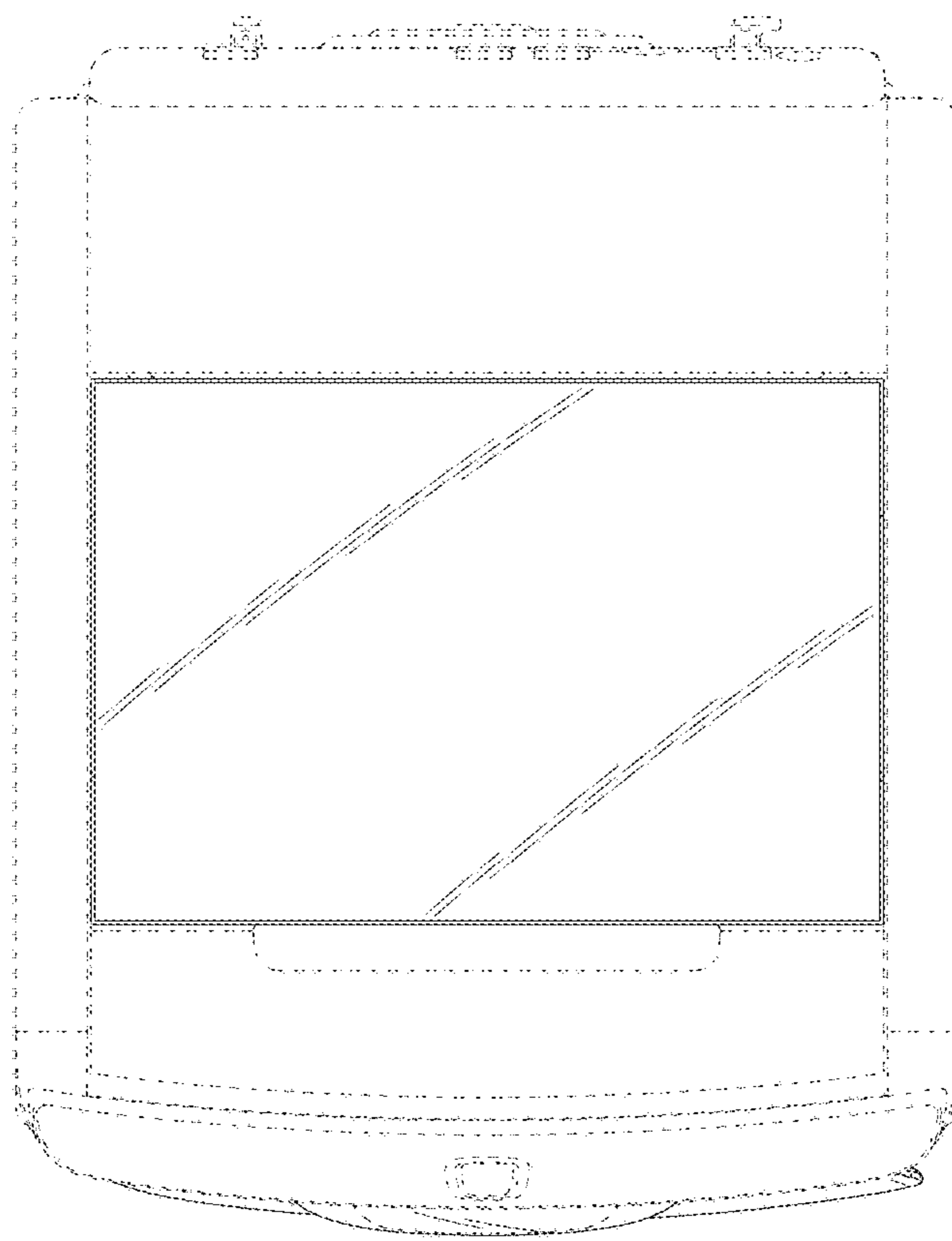

FIG. 7

