

US00D866075S

(12) **United States Design Patent**
Tammabattula

(10) **Patent No.:** **US D866,075 S**
(45) **Date of Patent:** **** Nov. 5, 2019**

- (54) **SONIC SKINCARE BRUSH**
- (71) Applicant: **Qyk Brands, LLC**, Santa Ana, CA (US)
- (72) Inventor: **Rakesh Tammabattula**, Santa Ana, CA (US)
- (73) Assignee: **Qyk Brands, LLC**, Santa Ana, CA (US)
- (**) Term: **15 Years**
- (21) Appl. No.: **29/699,183**
- (22) Filed: **Jul. 23, 2019**

- D716,961 S 11/2014 Sedic
 - D734,481 S 7/2015 Sedic
 - D764,172 S 8/2016 Pan
 - D767,226 S 9/2016 Albers
 - D769,455 S 10/2016 Sedic
- (Continued)

FOREIGN PATENT DOCUMENTS

- CN 303109591 S 2/2015
 - CN 303193705 S 5/2015
- (Continued)

OTHER PUBLICATIONS

Screenshots of QYK Sonic's Zoe Sonic Skincare Device from YouTube.com, video posted by a Brianna Stanko on Aug. 13, 2018 [online]. Retrieved from the Internet Jul. 17, 2019. URL: <https://www.youtube.com/watch?v=fMmJLA6Q8kU> 7 pages (Year: 2018).

(Continued)

Primary Examiner — Karen E Eldridge Powers
(74) *Attorney, Agent, or Firm* — Eric Kelly

Related U.S. Application Data

- (62) Division of application No. 29/680,596, filed on Feb. 18, 2019, now Pat. No. Des. 857,299.
- (51) **LOC (12) Cl.** **28-03**
- (52) **U.S. Cl.**
USPC **D28/63; D24/214; D4/100**
- (58) **Field of Classification Search**
USPC D4/100, 102, 121, 127, 128, 129, 130, D4/132, 133, 134, 136, 138, 199; D28/7, D28/63; D24/211, 214, 215; D32/35, 40
CPC . A47K 7/00; A47K 7/02; A47K 7/002; A47K 7/04; A47K 7/043; A61H 7/002; A61H 7/003; A61H 7/005; A61H 2205/022; A61H 2201/1692; A46B 2200/102; A46B 7/08; A46B 9/02; A46B 13/02; A46B 13/001
See application file for complete search history.

(57) **CLAIM**

What is claimed is the ornamental design for a sonic skincare brush, as shown and described.

DESCRIPTION

FIG. 1 illustrates a perspective view of a new and ornamental sonic skincare brush;
FIG. 2 illustrates a front elevation view thereof;
FIG. 3 illustrates a rear (back) elevation view thereof;
FIG. 4 illustrates a right-side elevation view thereof;
FIG. 5 illustrates a left-side elevation view thereof;
FIG. 6 illustrates a top plan view thereof; and,
FIG. 7 illustrates a bottom plan view thereof.
The broken lines in the figures depict portions of the sonic skincare brush that form no part of the claimed design.

(56) **References Cited**
U.S. PATENT DOCUMENTS

- 17,505,249 3/1929 Henry
- 7,500,282 B1 3/2009 Park
- D698,455 S 1/2014 Sedic

1 Claim, 5 Drawing Sheets

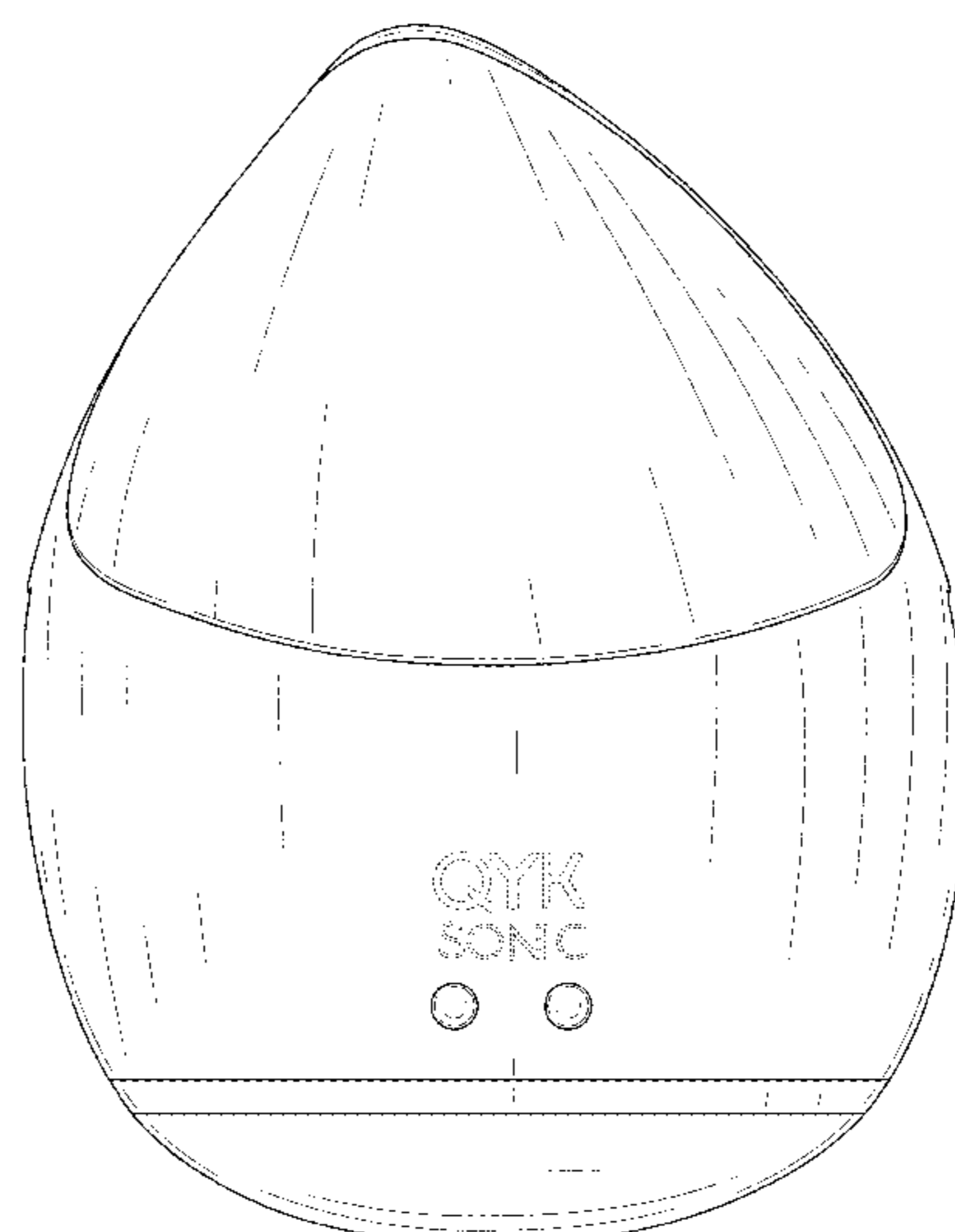
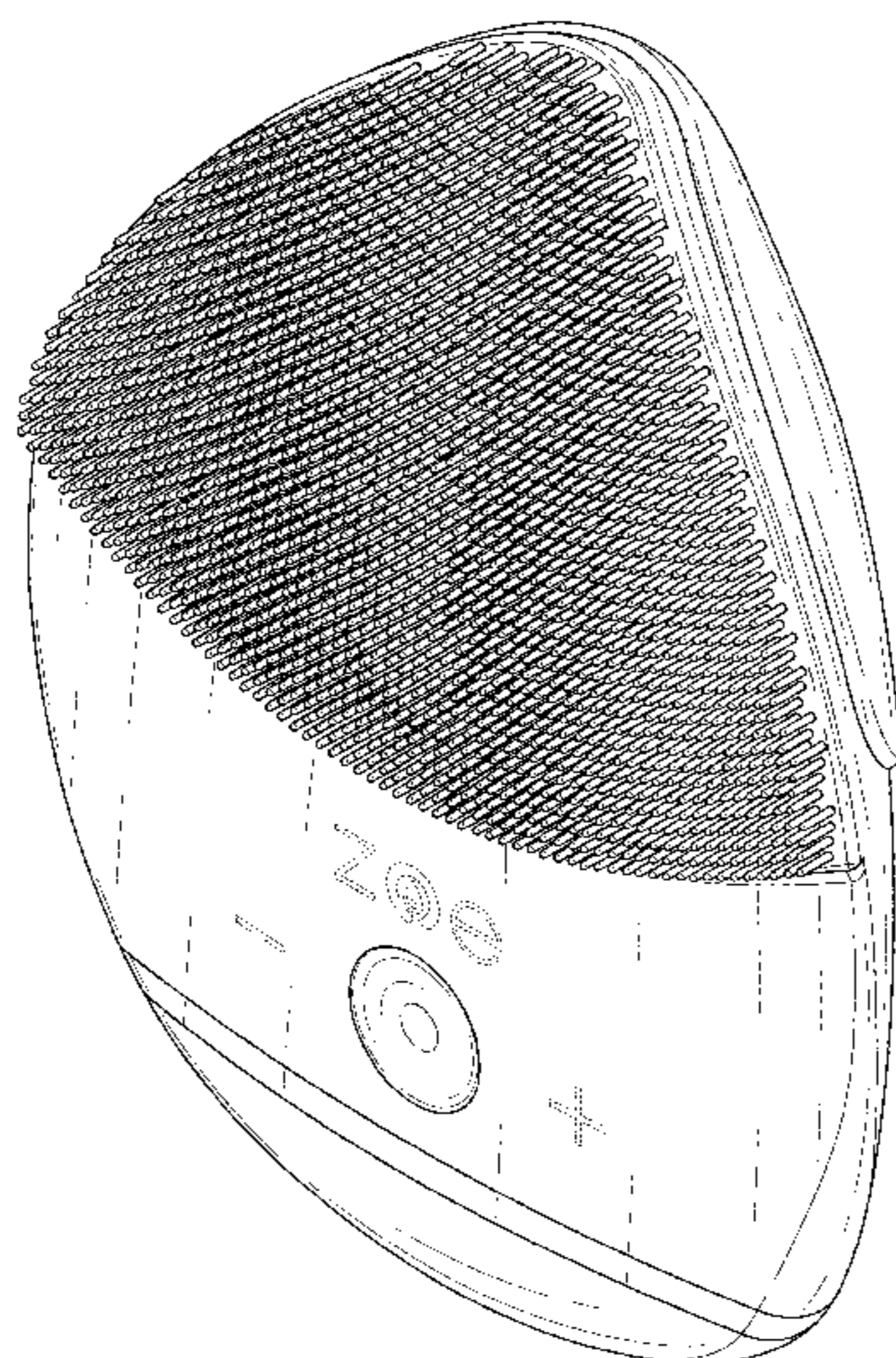

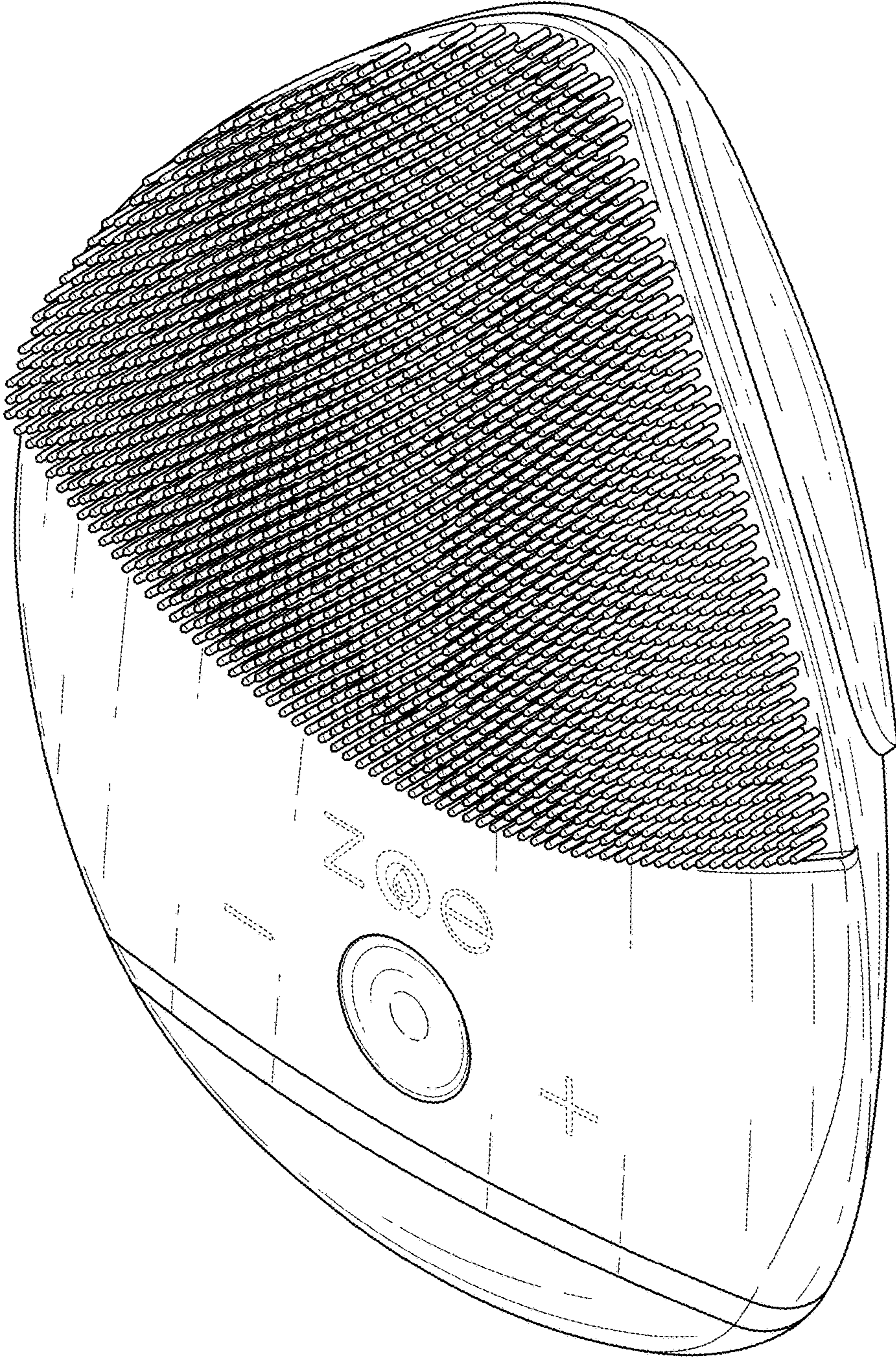

FIG. 1

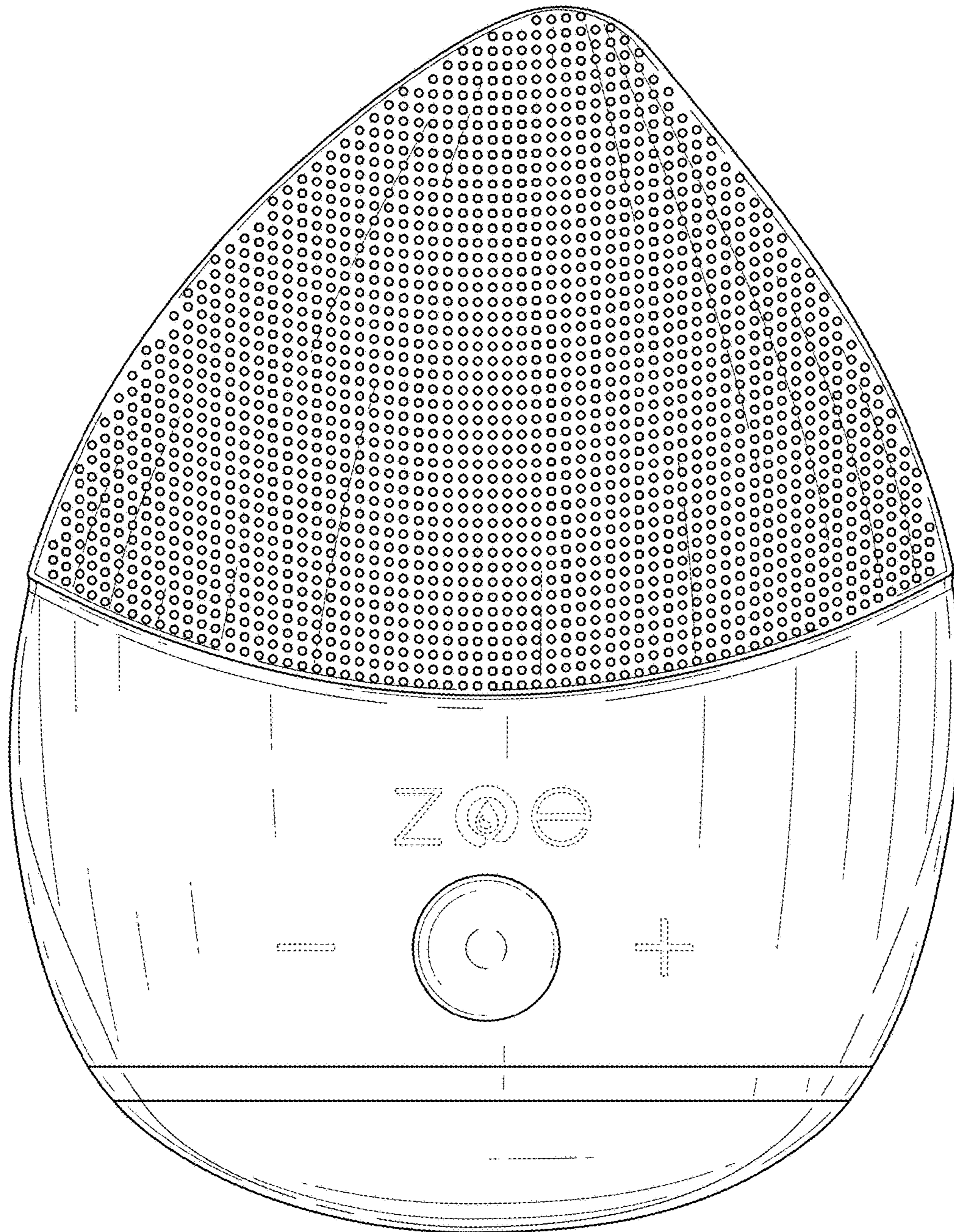

FIG. 2

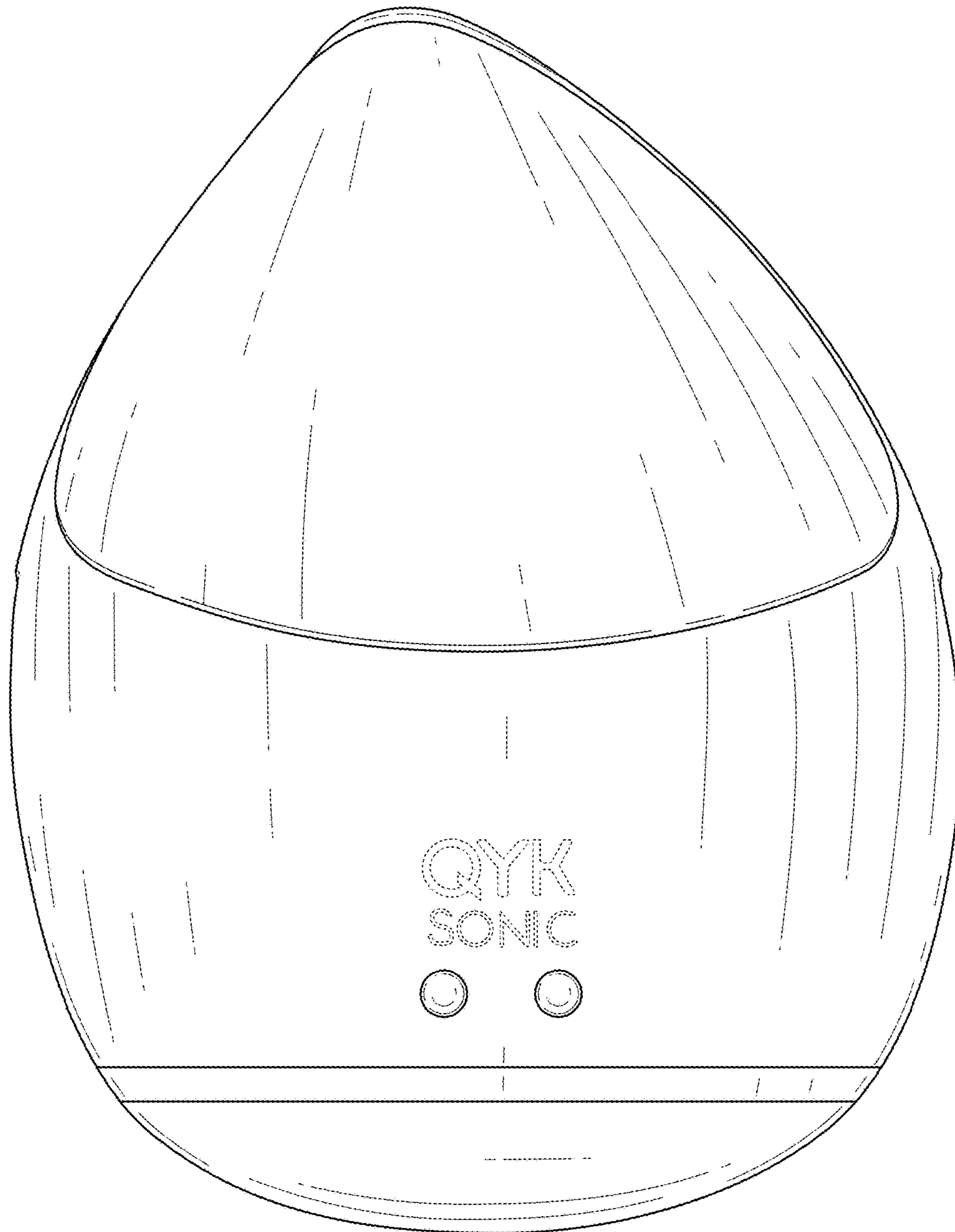

FIG. 3

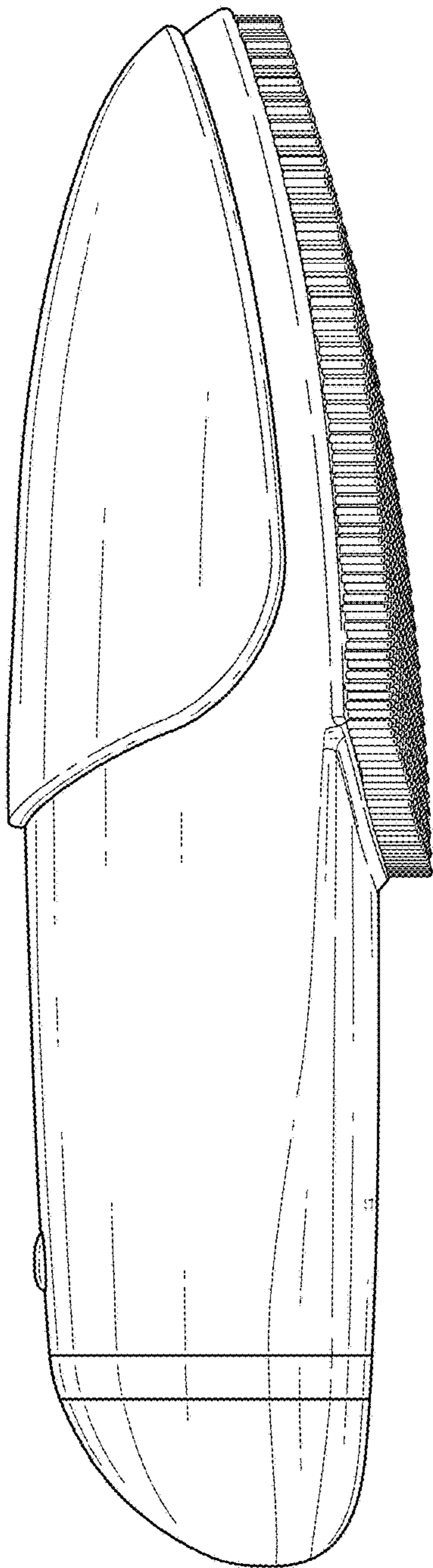

FIG. 4

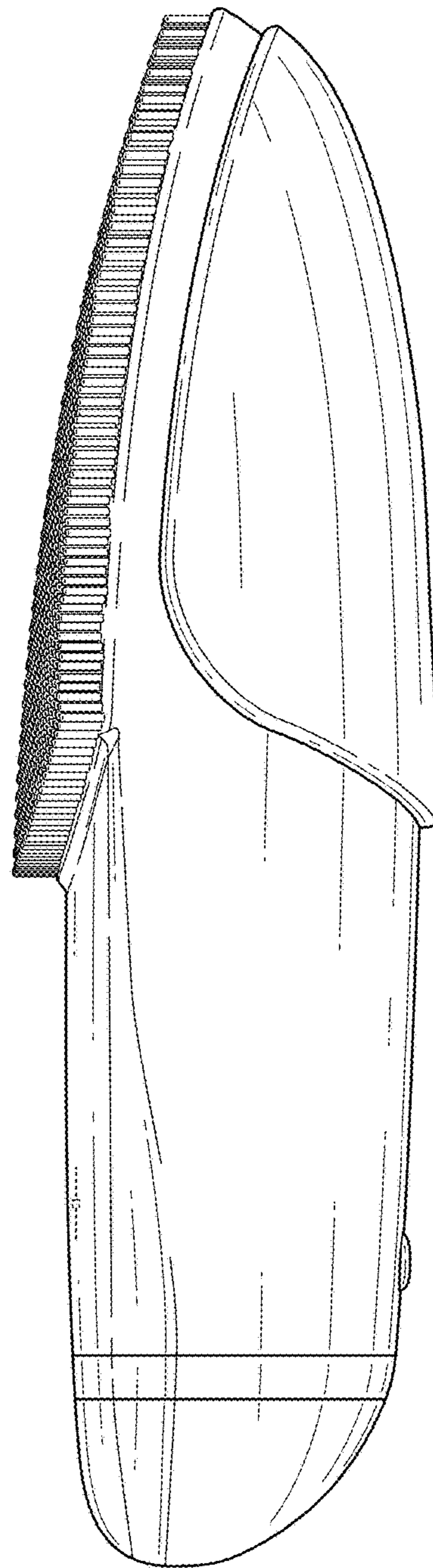

FIG. 5

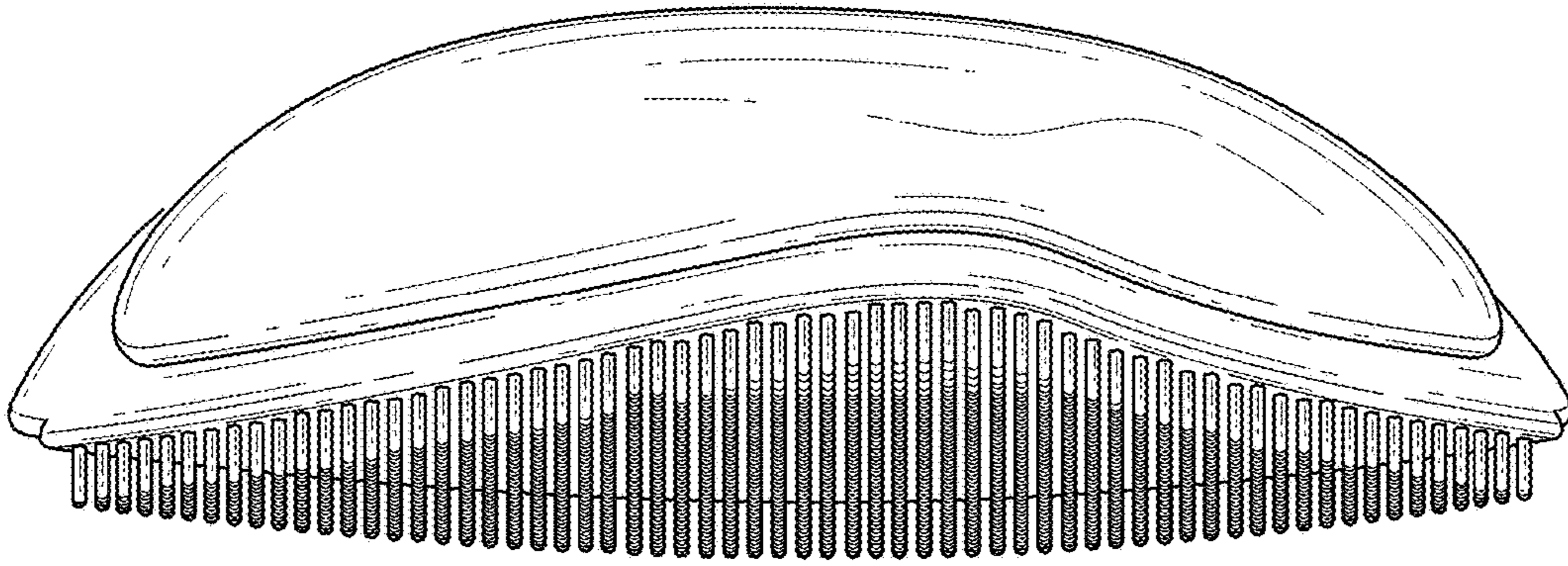

FIG. 6

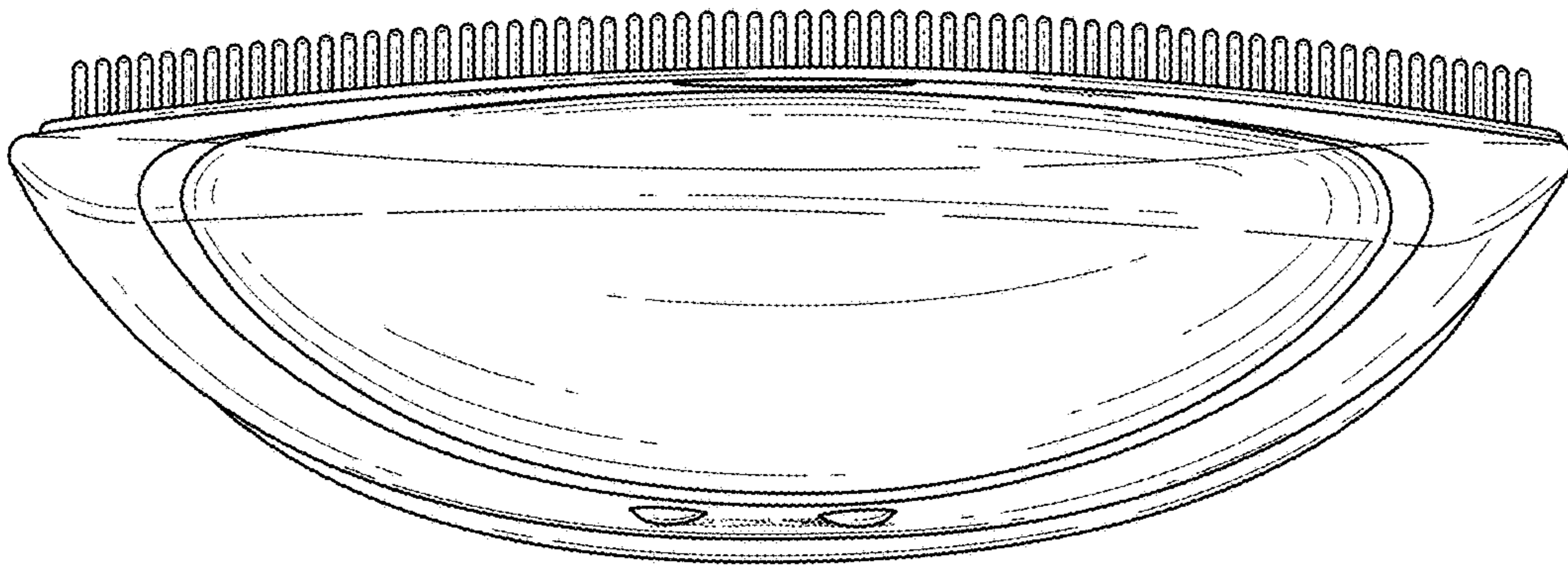

FIG. 7