



US00D866052S

(12) **United States Design Patent**
Jung et al.

(10) **Patent No.:** **US D866,052 S**

(45) **Date of Patent:** **** *Nov. 5, 2019**

(54) **CEILING LIGHT**

(71) Applicant: **LG DISPLAY CO., LTD.**, Seoul (KR)

(72) Inventors: **Seon Wook Jung**, Paju-si (KR); **Chi Young Lee**, Paju-si (KR); **Duck Su Oh**, Paju-si (KR); **Hye Cho Shin**, Paju-si (KR)

(73) Assignee: **LG DISPLAY CO., LTD.**, Seoul (KR)

(*) Notice: This patent is subject to a terminal disclaimer.

(**) Term: **15 Years**

(21) Appl. No.: **29/639,612**

(22) Filed: **Mar. 7, 2018**

(30) **Foreign Application Priority Data**

Sep. 7, 2017 (KR) 30-2017-0041998

(51) **LOC (12) Cl.** **26-03**

(52) **U.S. Cl.**
USPC **D26/91**

(58) **Field of Classification Search**
USPC D26/72, 80, 81, 82, 84, 85, 86, 88, 90, D26/91, 118, 120
CPC F21S 8/04; F21S 8/043; F21S 8/046; F21S 8/06; F21S 8/063; F21S 8/065; F21S 8/066; F21S 8/068
See application file for complete search history.

(56) **References Cited**

U.S. PATENT DOCUMENTS

- D45,521 S * 3/1914 Brinckerhoff D26/120
- D309,955 S * 8/1990 Gismondi D26/87
- D325,998 S * 5/1992 Shaw D26/131
- 6,227,687 B1 * 5/2001 Kahwaji F21S 6/005
362/248
- D540,978 S * 4/2007 Cormier D26/120
- D610,299 S * 2/2010 Ngai D26/120

- D613,449 S * 4/2010 Ngai D26/120
- D618,839 S * 6/2010 Ngai D26/120
- D636,521 S * 4/2011 Lovegrove D26/88
- D641,921 S * 7/2011 Sabernig D26/120
- D675,774 S * 2/2013 Stathis D26/120
- D675,775 S * 2/2013 Stathis D26/120
- D688,410 S * 8/2013 Ng D26/93
- D700,989 S * 3/2014 Rampolla D26/88
- D745,735 S * 12/2015 Tran D26/80
- D759,292 S * 6/2016 Zahn D26/120
- D769,507 S * 10/2016 Raasch F21S 6/005
D26/88

(Continued)

OTHER PUBLICATIONS

News Item dated Mar. 14, 2016 titled "LG Display to Showcase Cutting-edge OLED Light Products and Solutions at Light+Building 2016 in Frankfurt". <www.lgdisplay.com/eng/prcenter/newsList#> and <www.lgdisplay.com/eng/prcenter/newsView> (Year: 2016).*

(Continued)

Primary Examiner — Clare E Heflin

(74) *Attorney, Agent, or Firm* — Birch, Stewart, Kolasch & Birch, LLP

(57) **CLAIM**

The ornamental design for a ceiling light, as shown and described.

DESCRIPTION

FIG. 1 is a perspective view of the ceiling light showing our new design;
FIG. 2 is a front view thereof;
FIG. 3 is a rear view thereof;
FIG. 4 is a left-side view thereof;
FIG. 5 is a right-side view thereof;
FIG. 6 is a top plan view thereof;
FIG. 7 is a bottom view thereof; and,
FIG. 8 is an exploded perspective view thereof.

1 Claim, 8 Drawing Sheets

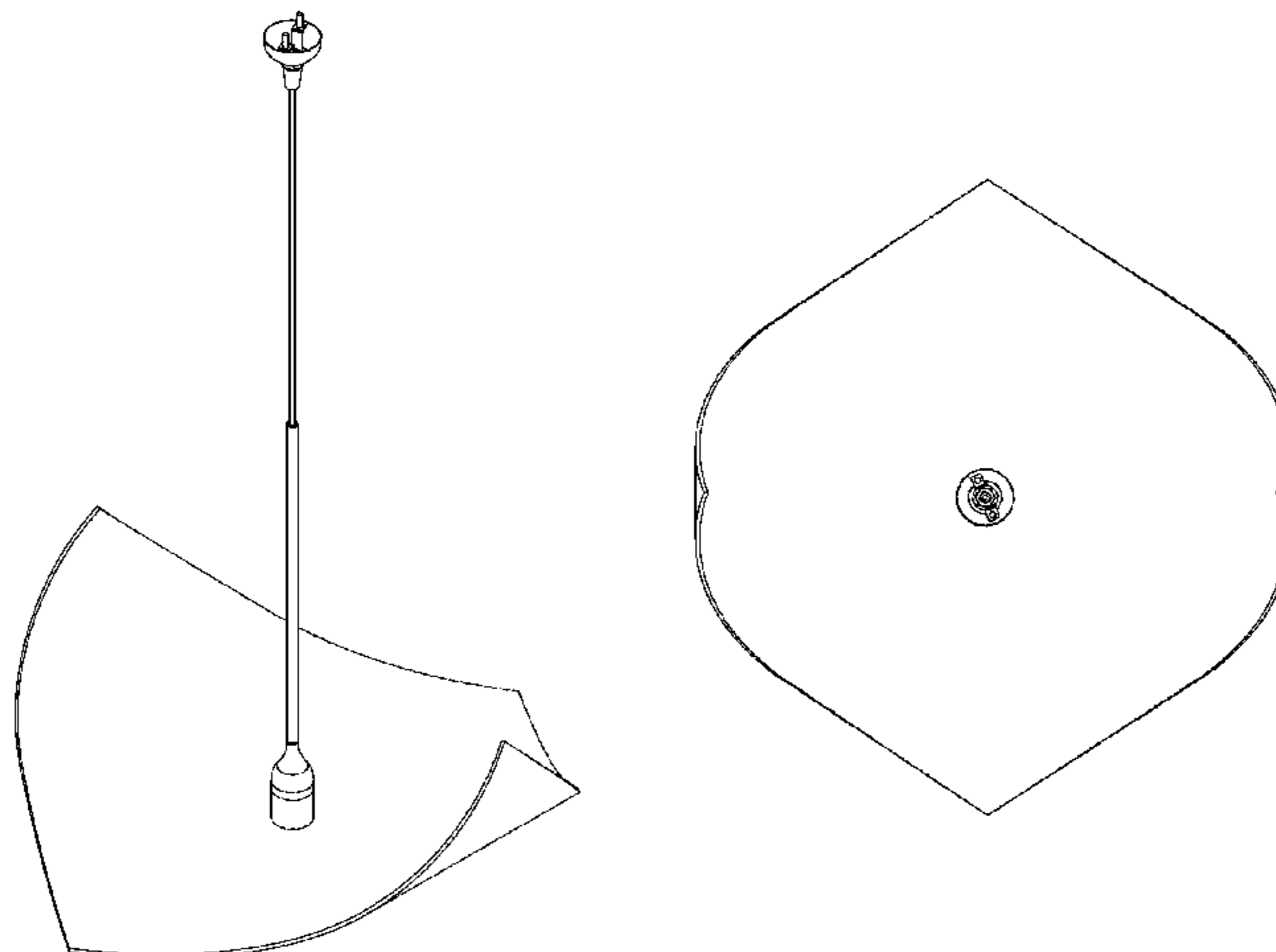

(56)

References Cited

U.S. PATENT DOCUMENTS

D781,493 S * 3/2017 Urquiola D26/118
D791,386 S * 7/2017 Arndt D26/88
D792,005 S * 7/2017 Sonneman D26/87
D797,347 S * 9/2017 Sonneman D26/86
D801,575 S * 10/2017 Chung D26/120
D807,561 S * 1/2018 Ng D26/88
D829,958 S * 10/2018 Brennenstuhl D26/88

OTHER PUBLICATIONS

Article titled, "LG Display to Build World's First 5th Generation OLED Light Panel Plant" from PR Newswire, published Mar. 17, 2016. <<https://www.prnewswire.com/news-releases/lg-display-to-build-worlds-first-5th-generation-oled-light-panel-plant-300237655.html>> (Year: 2016).*

LG Display OLED light at Light+Building 2016 video, published Mar. 29, 2016. <https://www.youtube.com/watch?time_continue=30&v=NufH1LwIERA> (Year: 2016).*

* cited by examiner

FIG. 1

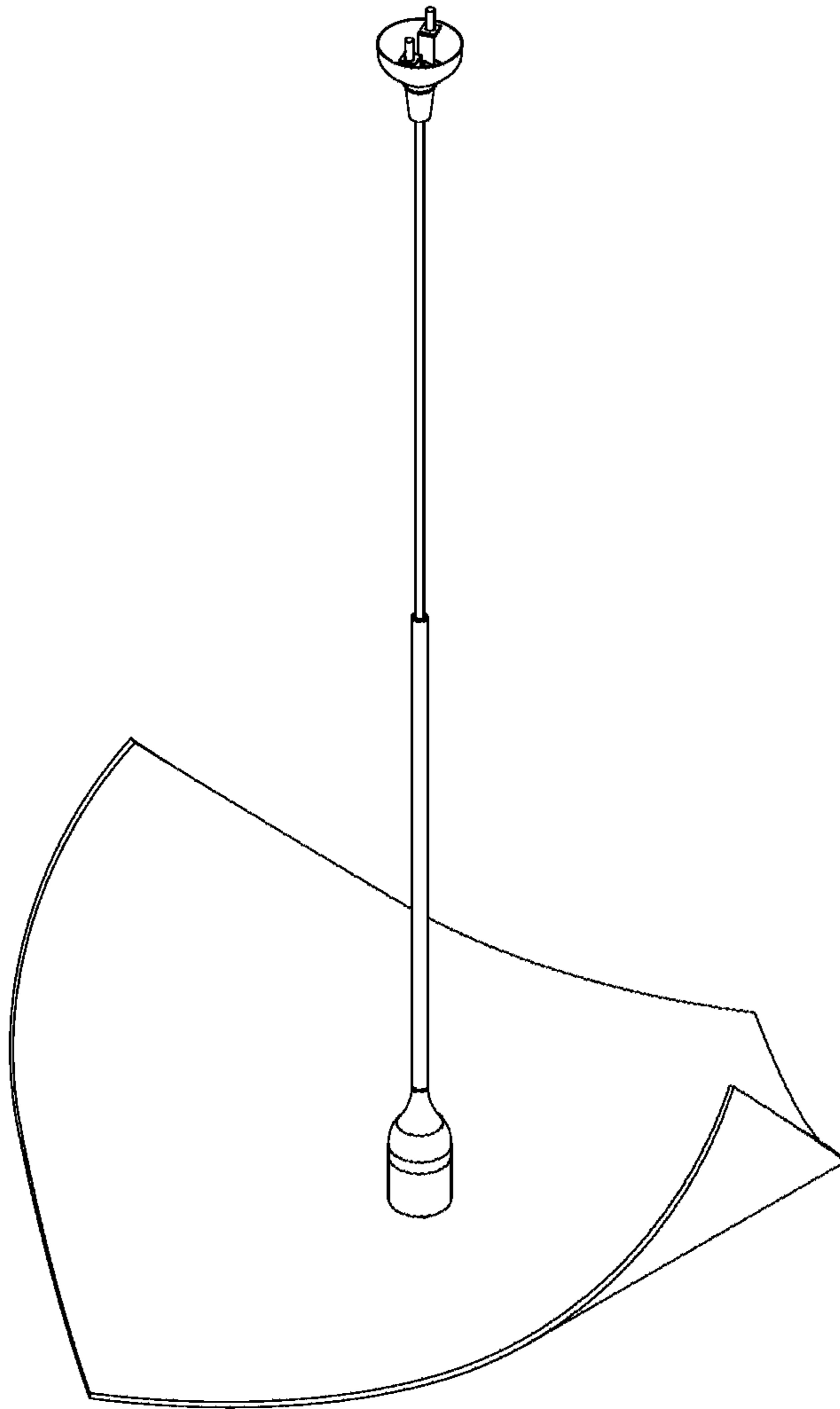

FIG. 2

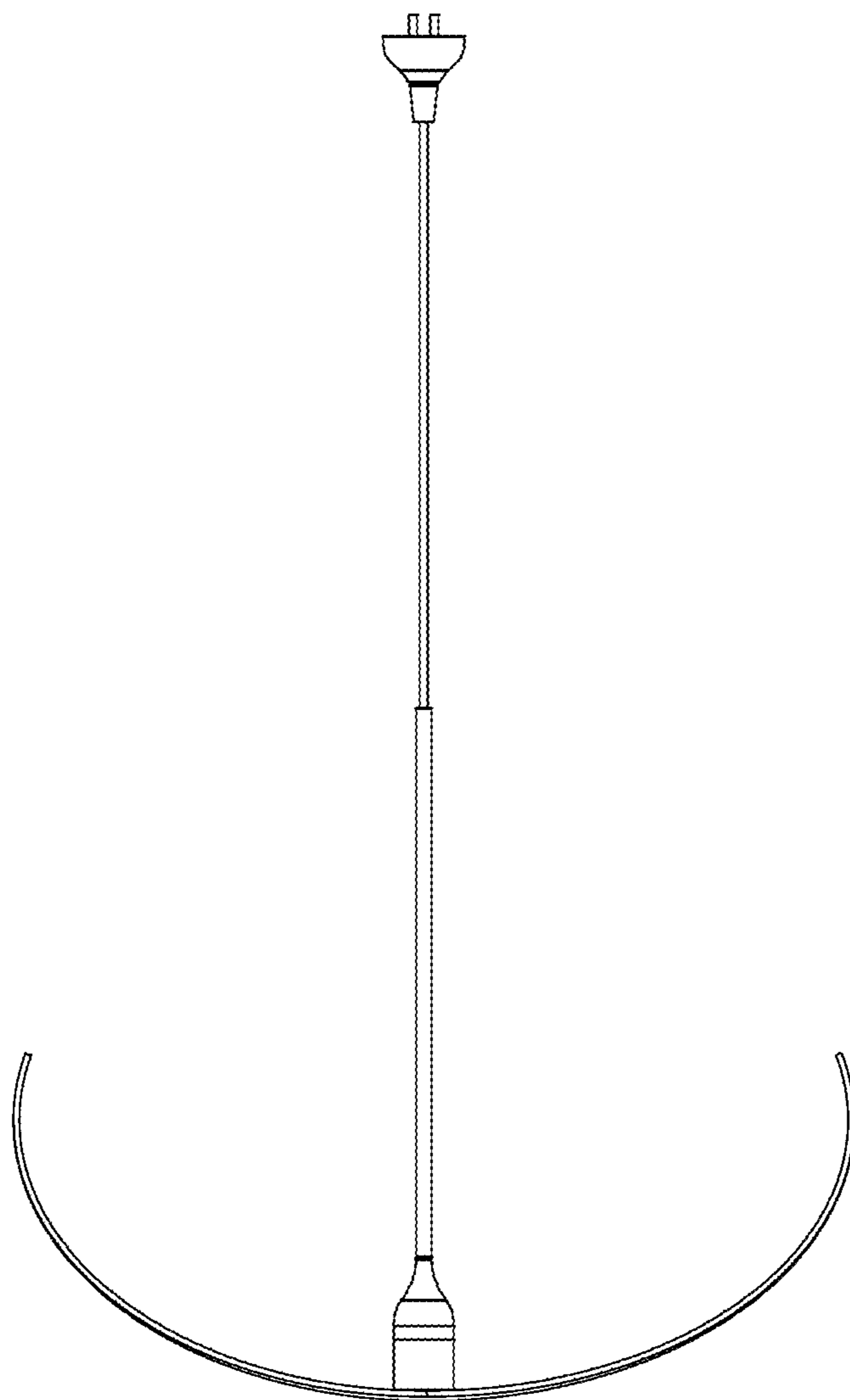

FIG. 3

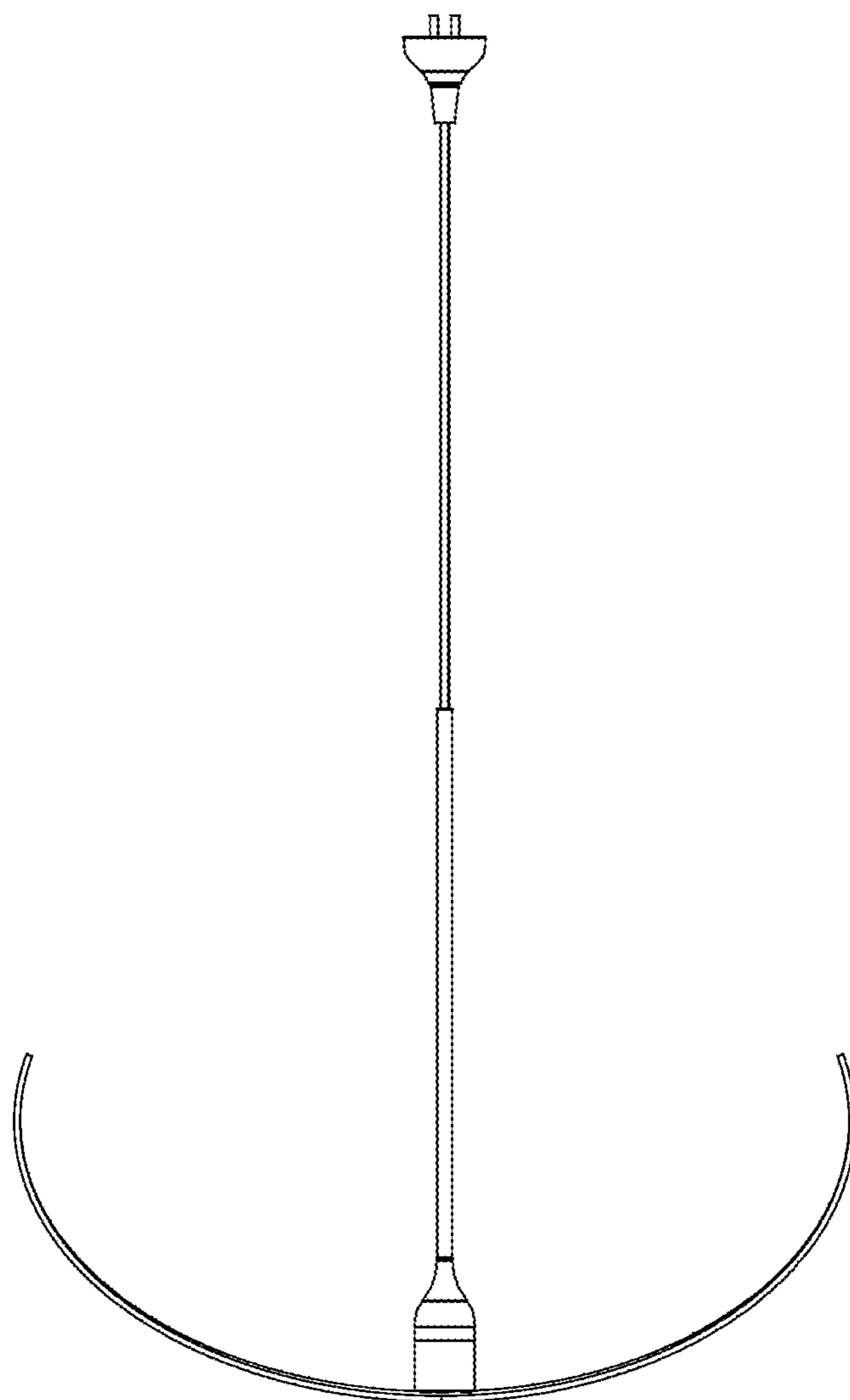

FIG. 4

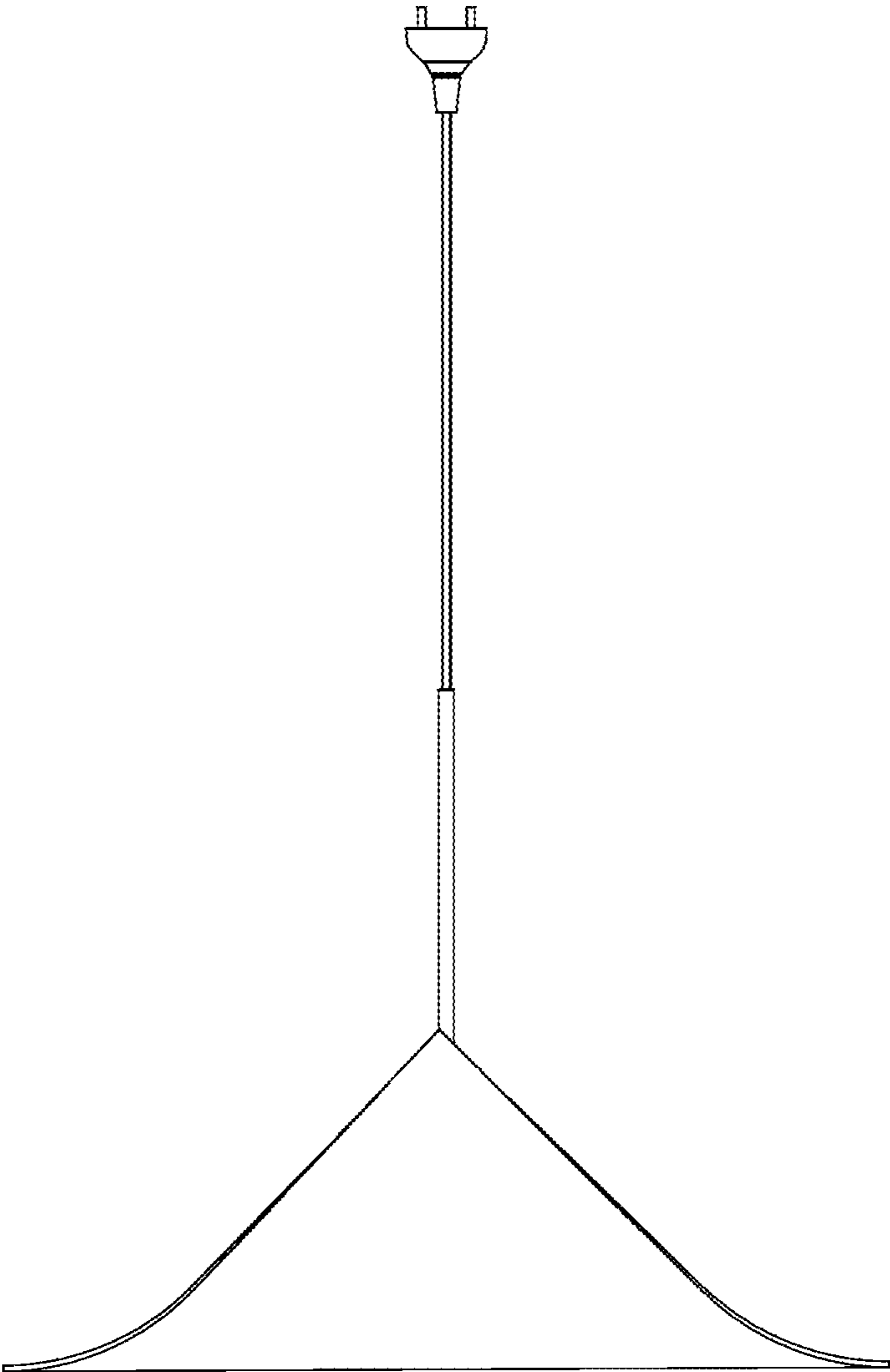

FIG. 5

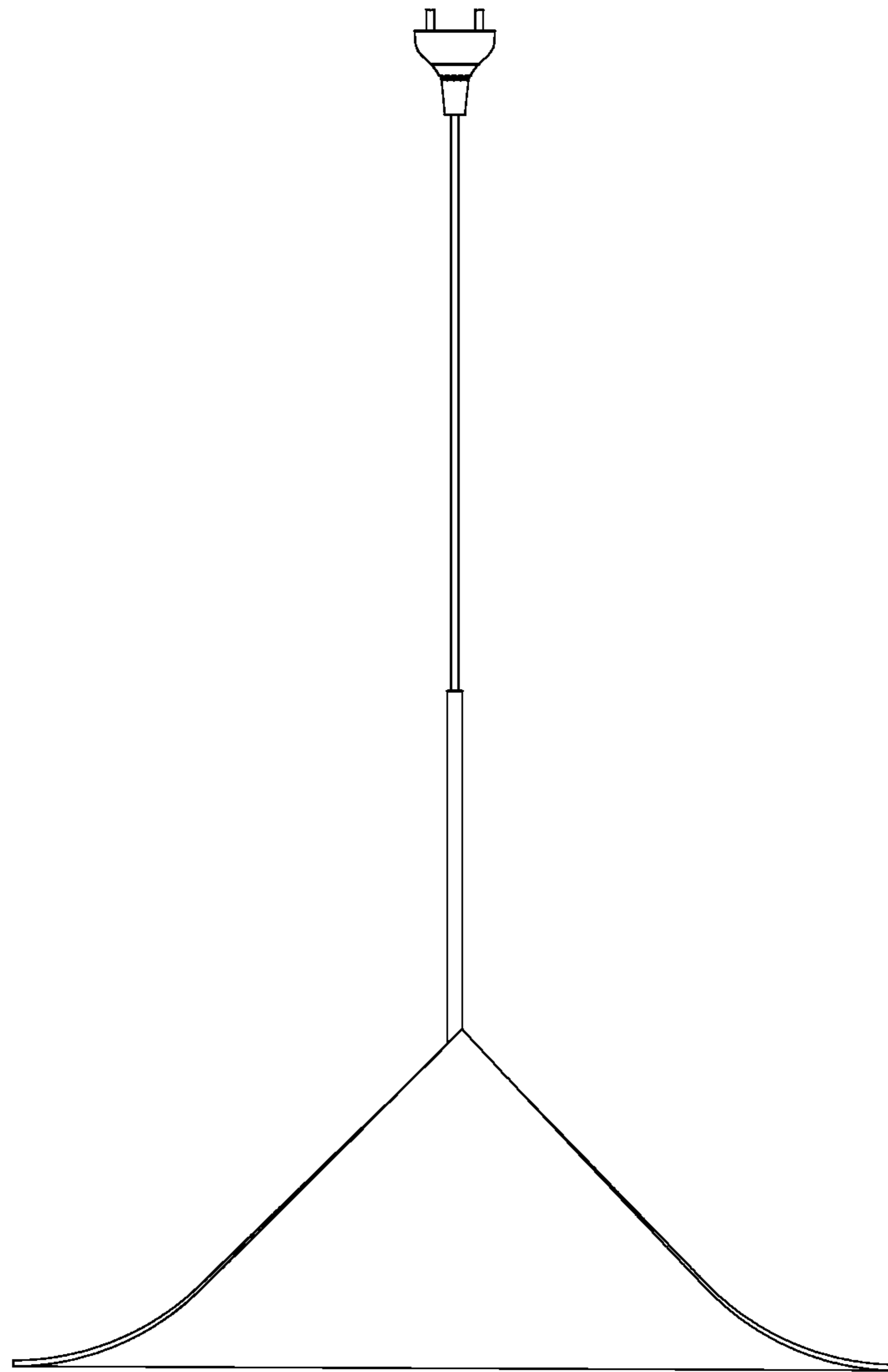

FIG. 6

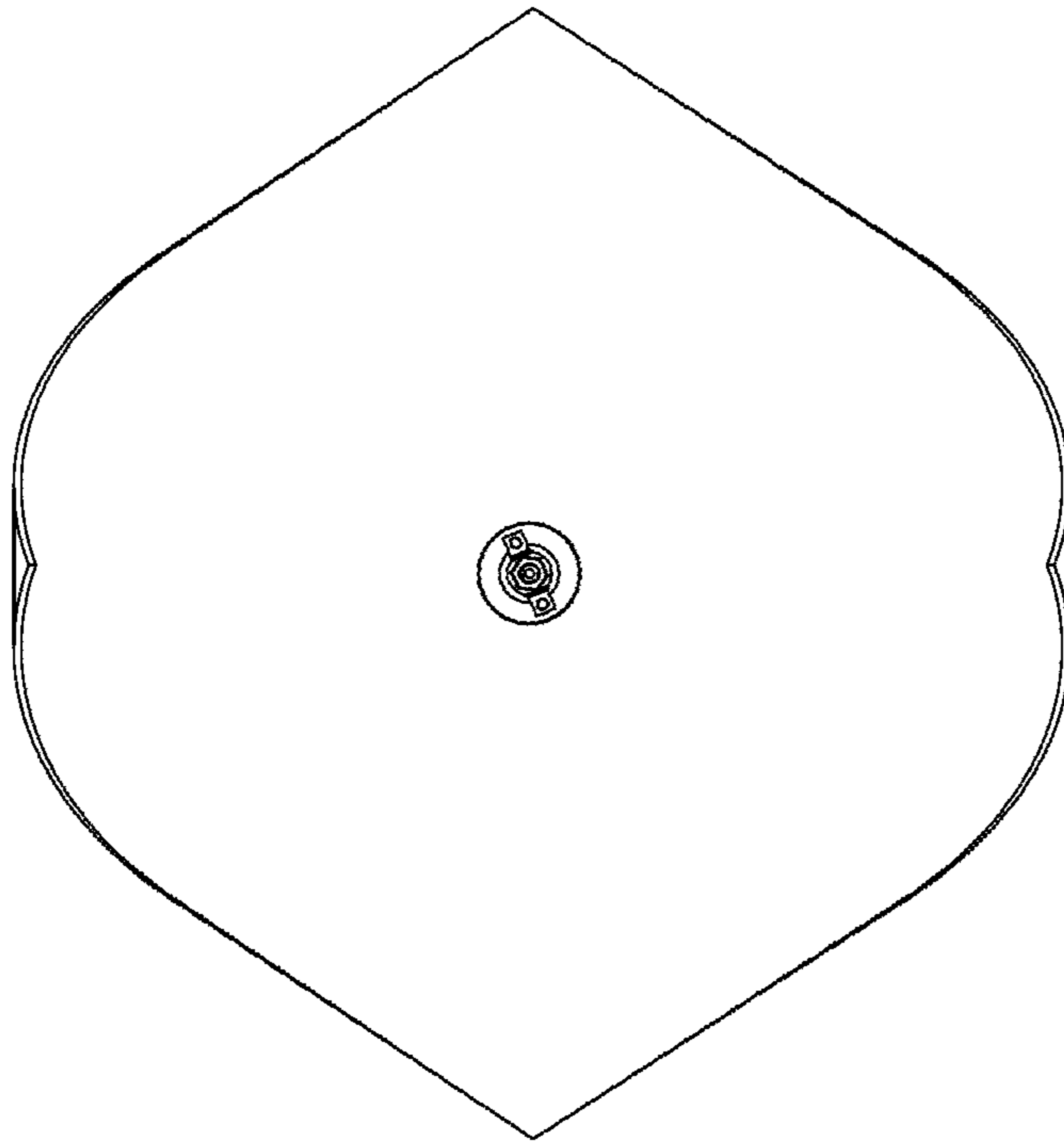

FIG. 7

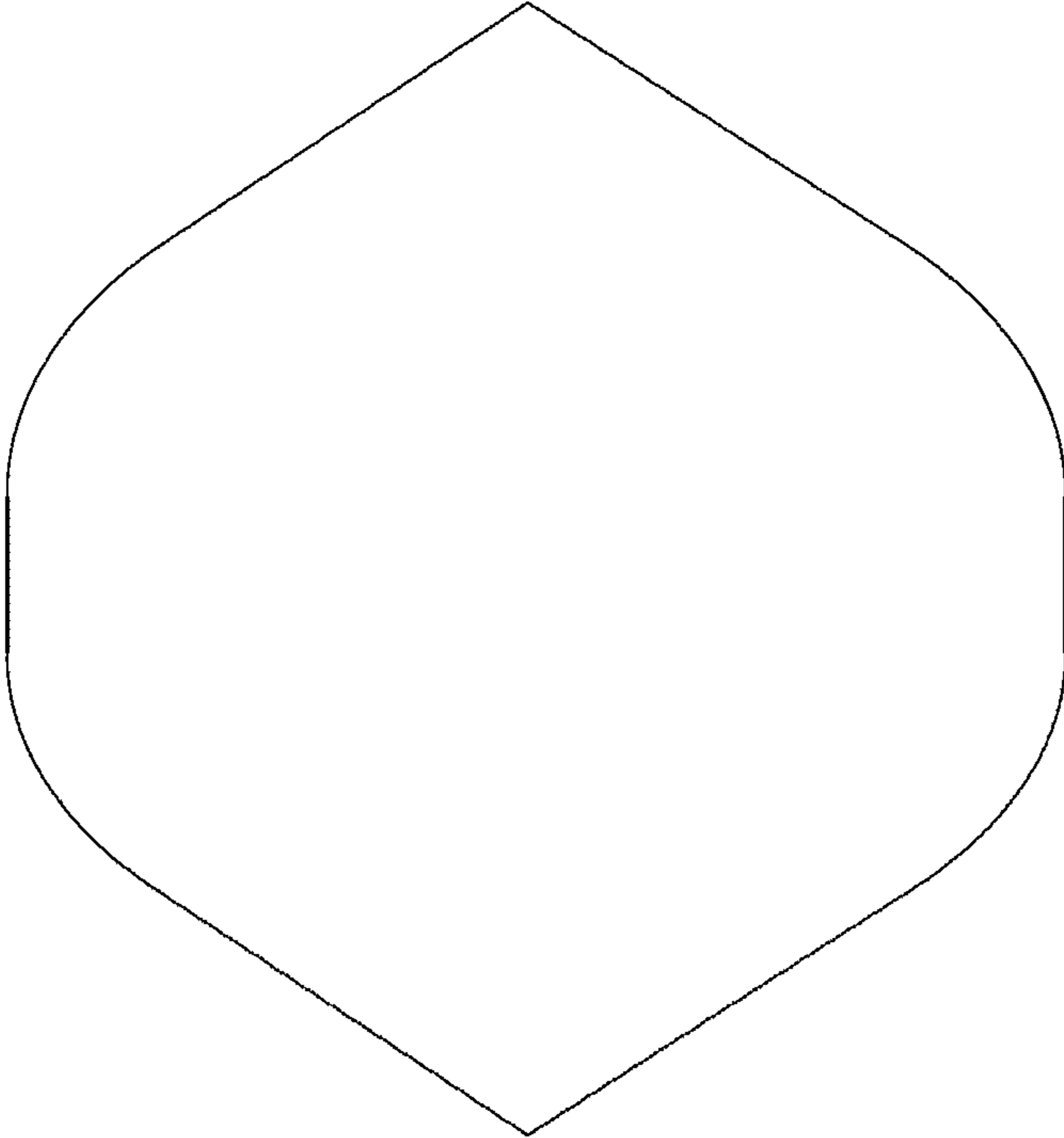

FIG. 8

