



US00D865966S

(12) **United States Design Patent** (10) **Patent No.:** **US D865,966 S**
Guyon (45) **Date of Patent:** **** Nov. 5, 2019**

(54) **KNEE PROSTHESIS**
 (71) Applicant: **PROTEOR**, Saint-Apollinaire (FR)
 (72) Inventor: **Jerome Guyon**, Labergement les Seurre (FR)

D523,959 S * 6/2006 Muehlenberend D24/155
 D525,709 S * 7/2006 Boiten D24/155
 D721,810 S * 1/2015 Sigurdsson D24/155
 D736,385 S * 8/2015 Nakaya D24/155
 D745,677 S * 12/2015 Sigurdsson D24/155
 D785,177 S * 4/2017 Gonzalez D24/155

* cited by examiner

(73) Assignee: **PROTEOR**, Saint-Apollinaire (FR)

(**) Term: **15 Years**

Primary Examiner — Charles D Hanson
 (74) *Attorney, Agent, or Firm* — Patricia Wilczynski Brozek; Pokalsky Wilczynski Brozek

(21) Appl. No.: **29/589,910**

(22) Filed: **Jan. 5, 2017**

(30) **Foreign Application Priority Data**

Jul. 19, 2016 (EM) 003311687

(51) **LOC (12) Cl.** **24-03**

(52) **U.S. Cl.**
USPC **D24/155**

(58) **Field of Classification Search**
 USPC D24/155
 CPC A61F 2/80; A61F 2/60; A61F 2/76; A61F 2/68; A61F 2/64; A61F 2220/0025; A61F 2220/41; A61F 2002/607; A61F 2002/802; A61F 2002/5007
 See application file for complete search history.

(56) **References Cited**

U.S. PATENT DOCUMENTS

D383,542 S * 9/1997 Wellershaus D24/155
 D522,142 S * 5/2006 Boiten D24/155

(57) **CLAIM**

The ornamental design for a knee prosthesis, as shown and described.

DESCRIPTION

FIG. 1 is a perspective view of a knee prosthesis showing my new design;
 FIG. 2 is a left side view thereof;
 FIG. 3 is a right side view thereof;
 FIG. 4 is a front elevation view thereof;
 FIG. 5 is a back elevation view thereof;
 FIG. 6 is a top plan view thereof; and,
 FIG. 7 is a bottom plan view thereof.
 The broken lines where shown are for illustrative purposes only and form no part of the claimed design.

1 Claim, 6 Drawing Sheets

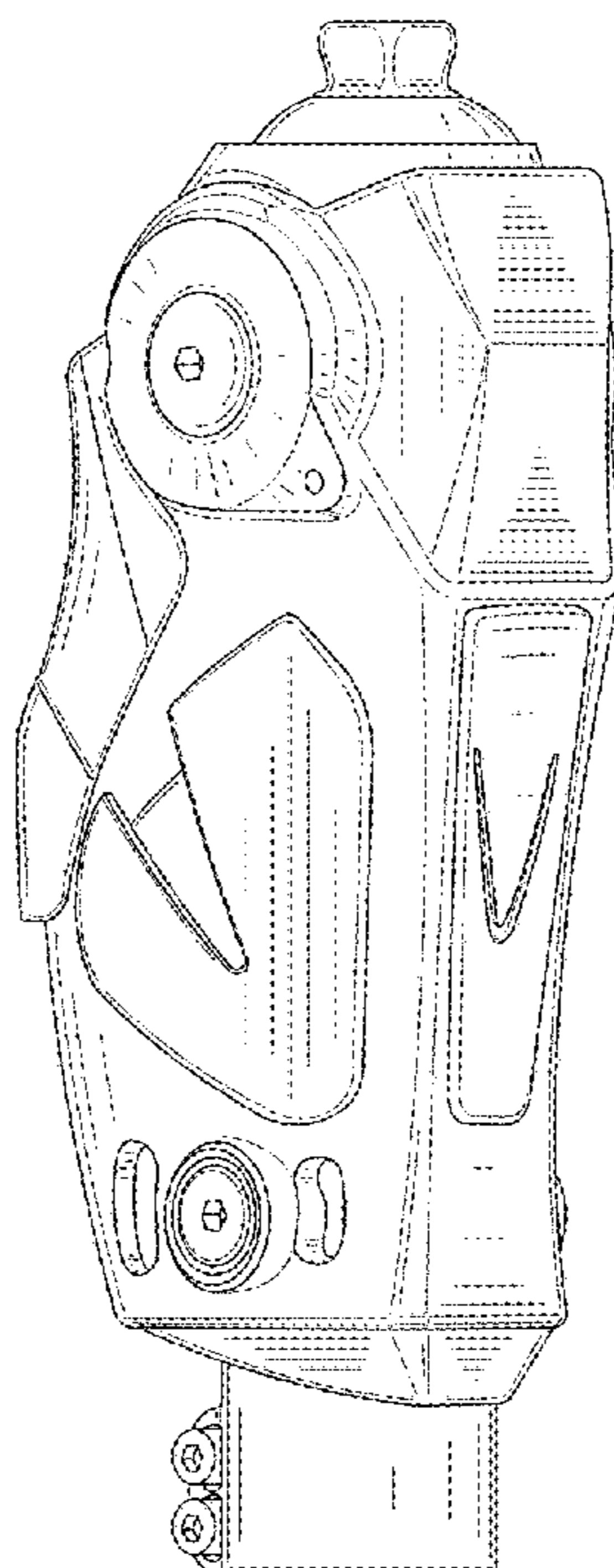

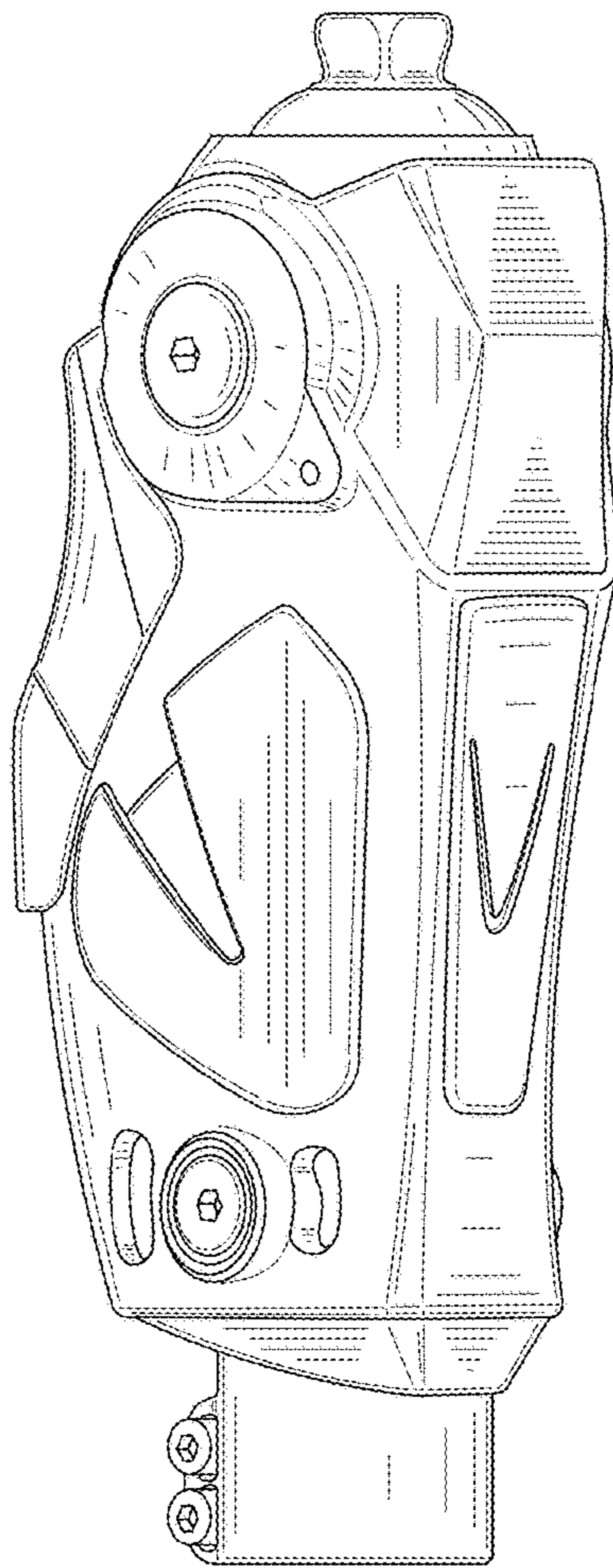

FIG. 1

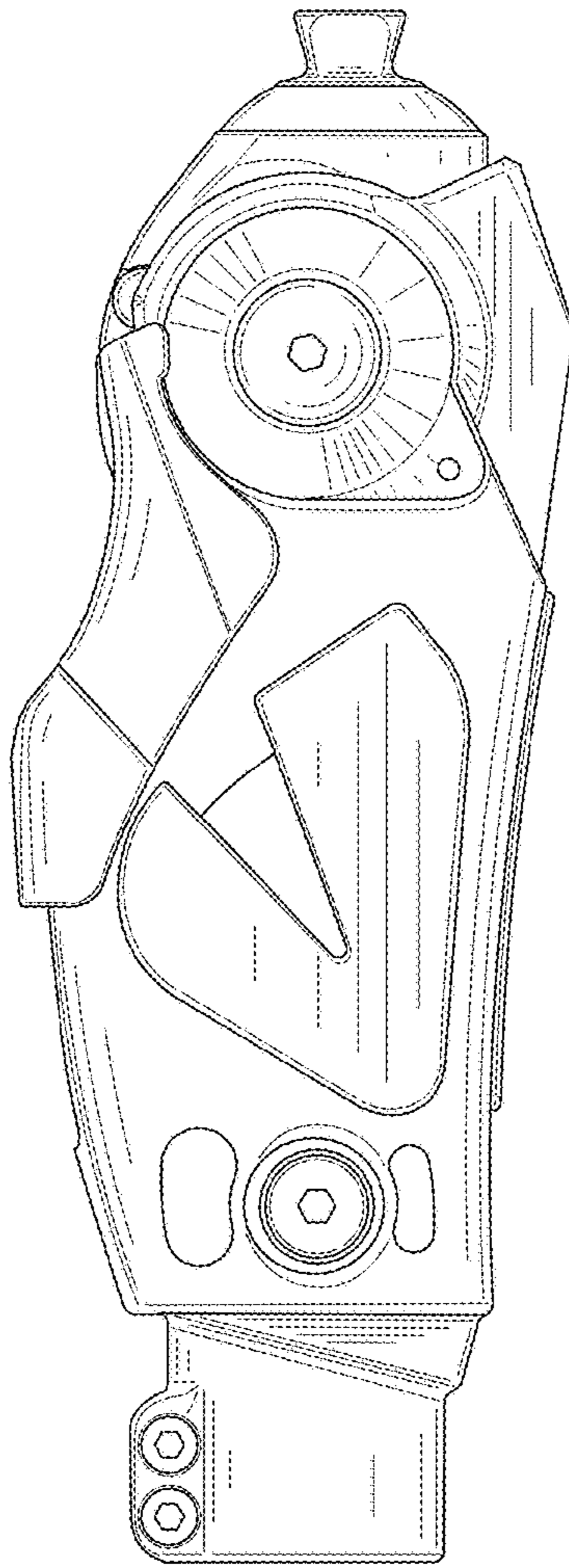

FIG. 2

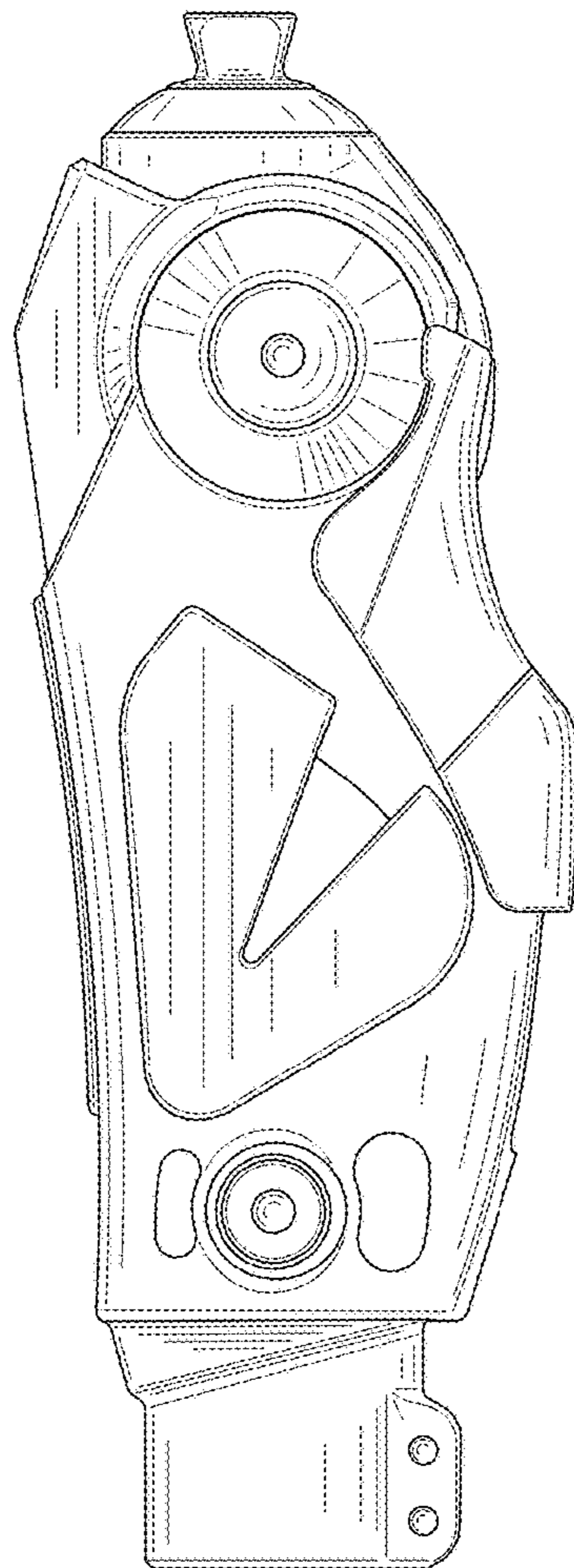

FIG. 3

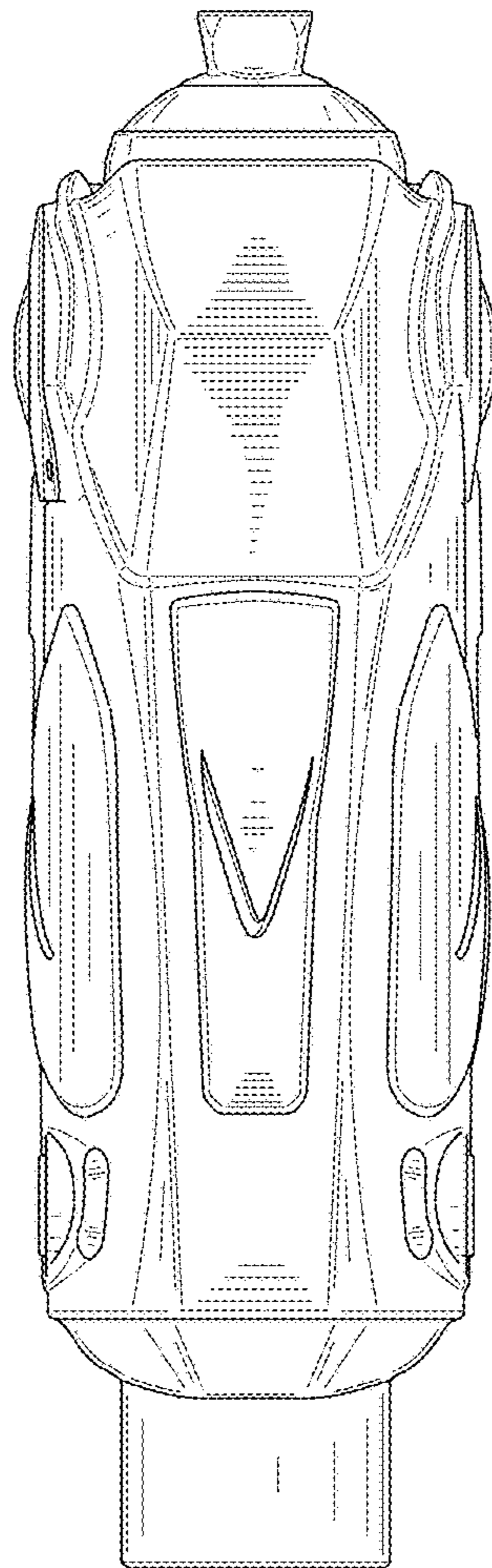

FIG. 4

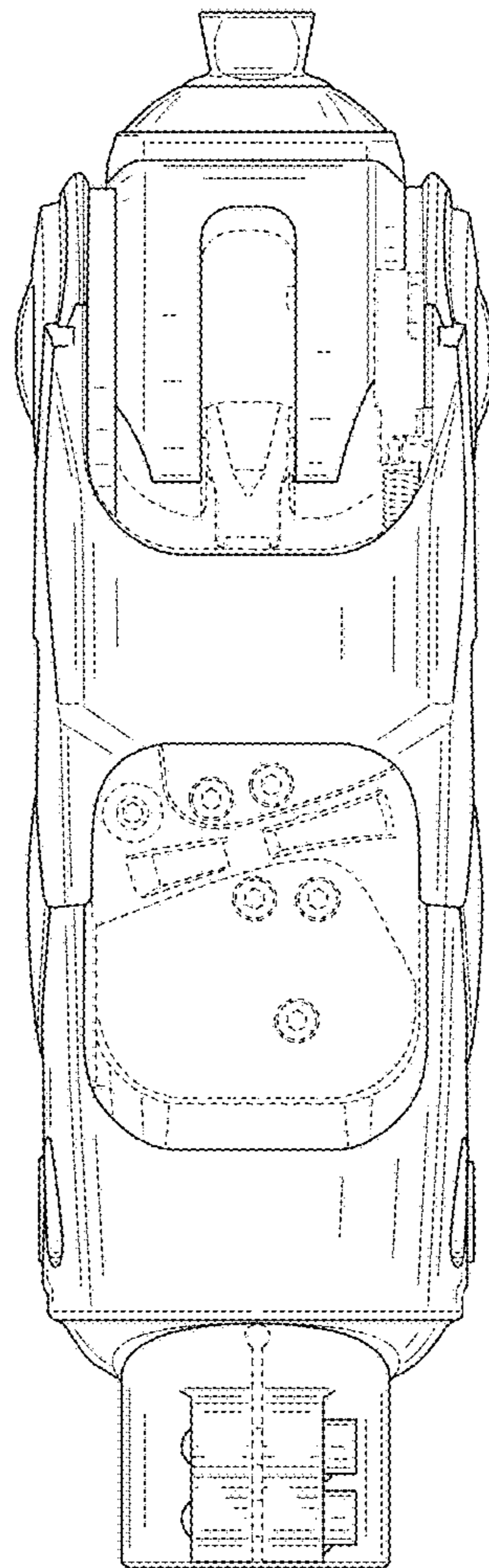

FIG. 5

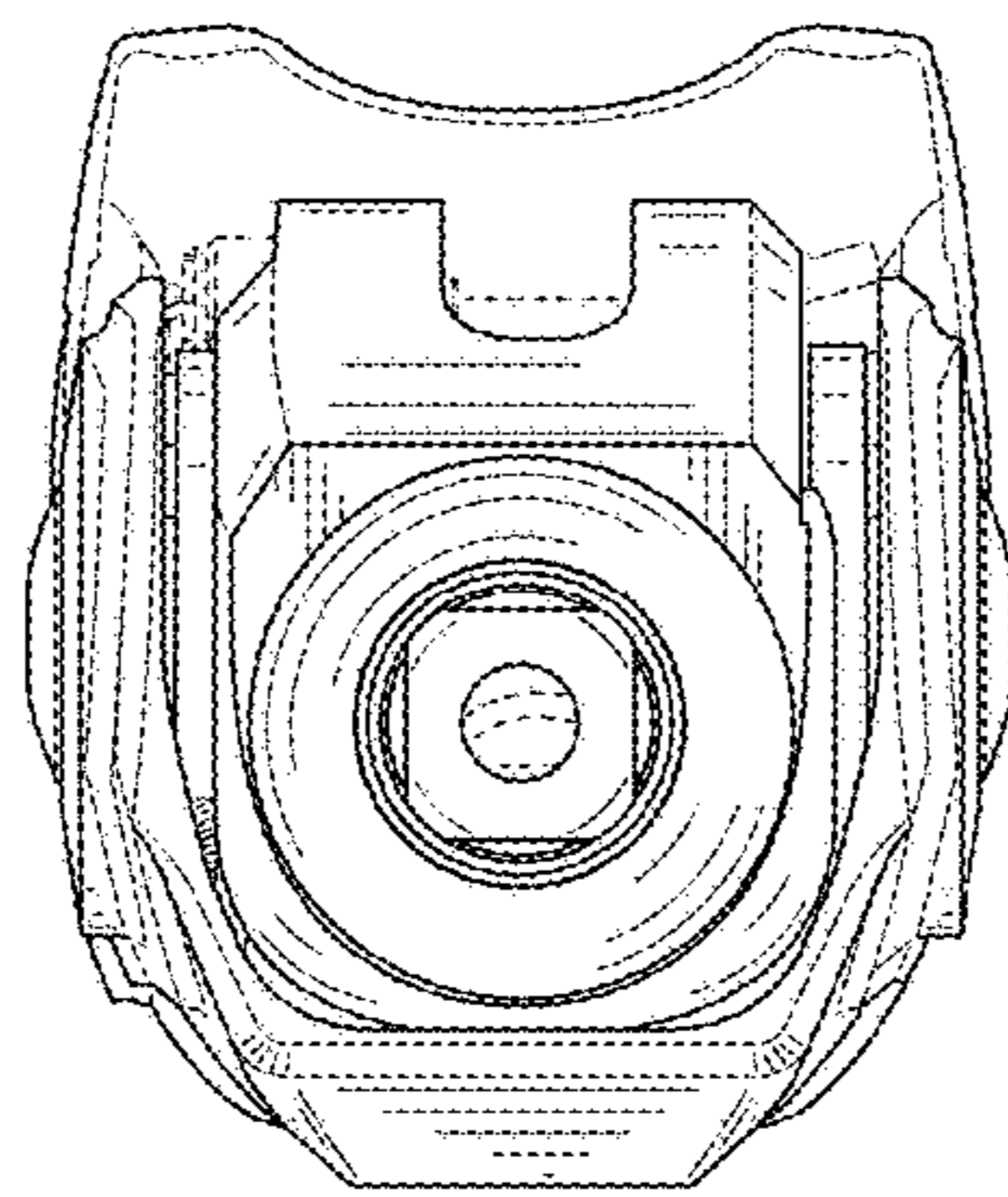

FIG. 6

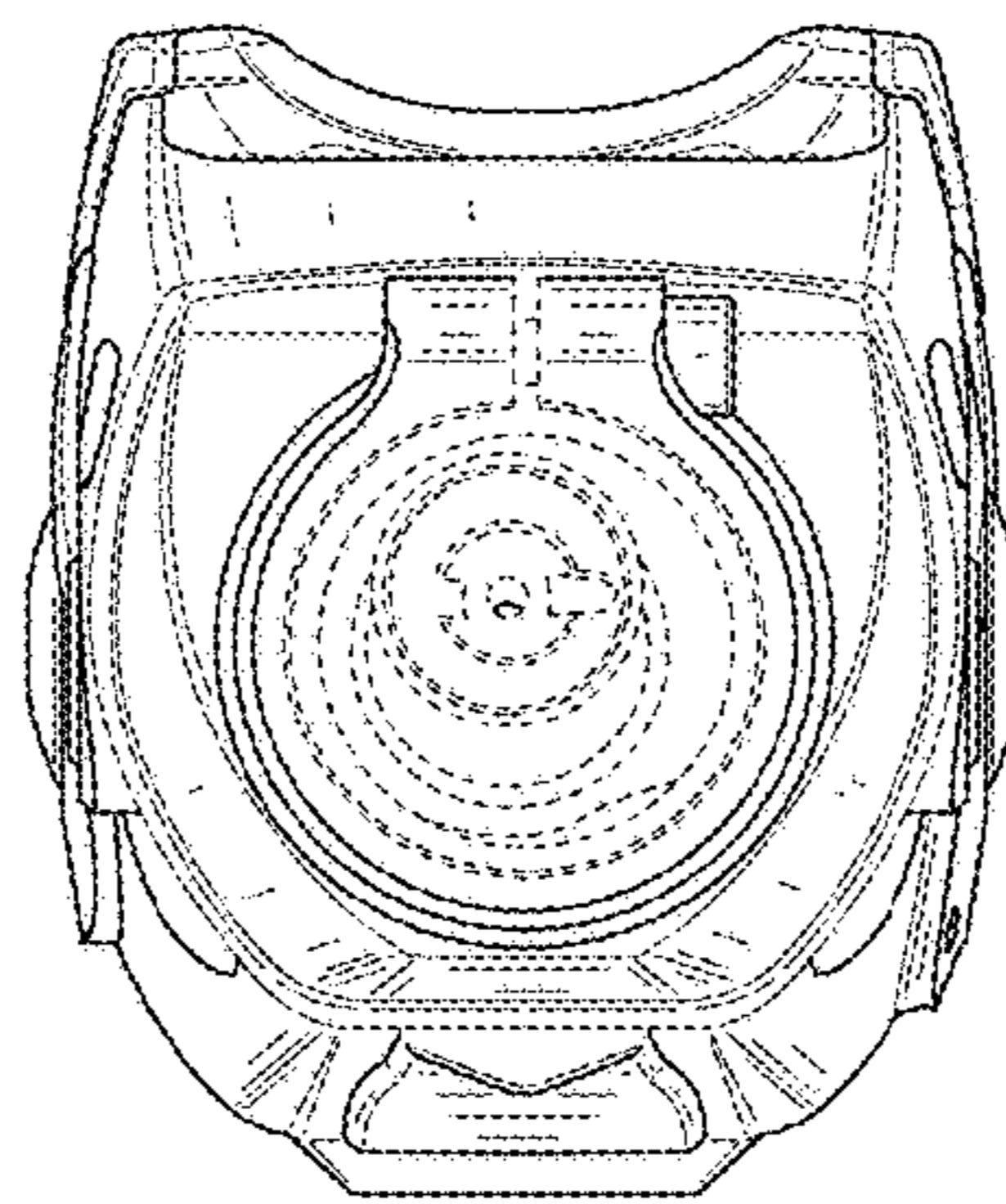

FIG. 7