



US00D865934S

(12) **United States Design Patent**
Long

(10) **Patent No.:** **US D865,934 S**

(45) **Date of Patent:** **** Nov. 5, 2019**

(54) **AROMA DIFFUSER**

(71) Applicant: **Shenzhen Tingson Electrical Technology Co., LTD**, Shenzhen, Guangdong (CN)

(72) Inventor: **Jun Long**, Guangdong (CN)

(73) Assignee: **Shenzhen Tingson Electrical Technology Co., Ltd**, Shenzhen (CN)

(**) Term: **15 Years**

(21) Appl. No.: **29/630,184**

(22) Filed: **Dec. 19, 2017**

(30) **Foreign Application Priority Data**

Oct. 20, 2017 (CN) 2017 3 0503023

(51) **LOC (12) Cl.** **28-99**

(52) **U.S. Cl.**
USPC **D23/366**

(58) **Field of Classification Search**
USPC D23/314, 325, 333-336, 355-369,
D23/386-388; D6/314; D14/209, 215,
D14/216; D9/522, 549, 566; D20/43
CPC . A61L 9/03; A61L 9/012; A61L 9/015; A61L
9/037; F41J 1/01
See application file for complete search history.

(56) **References Cited**

U.S. PATENT DOCUMENTS

D305,262 S	*	12/1989	Nichols	D24/115
D426,300 S	*	6/2000	Conforti	D24/115
D510,134 S	*	9/2005	Lablaine	D23/366
D536,434 S	*	2/2007	DongSheng	D23/366
D577,428 S	*	9/2008	Sun	D23/366
D672,607 S	*	12/2012	Hainan	D7/300
D696,892 S	*	1/2014	Bretillot	D23/366

D700,847 S	*	3/2014	Chapman	D9/724
D717,173 S	*	11/2014	Wechsler	D9/435
D717,515 S	*	11/2014	Khan	D99/5
D735,314 S	*	7/2015	Benamor	D23/366
D755,361 S	*	5/2016	Osborn	D23/366
D758,867 S	*	6/2016	Tsai	D28/89
D779,055 S	*	2/2017	Mehta	D24/115
D810,909 S	*	2/2018	Yu	D23/366
D810,910 S	*	2/2018	Yu	D23/366
D812,210 S	*	3/2018	Tang	D23/366
D839,405 S	*	1/2019	Hu	D23/366
D841,794 S	*	2/2019	Xu	D23/356
2018/0214593 A1	*	8/2018	Breen	A61L 9/12

OTHER PUBLICATIONS

Eickar ELF Aroma Diffuser reference [Apr. 27, 2019] found online [Apr. 27, 2019]—<http://www.aickar.com/>.*

* cited by examiner

Primary Examiner — Brandon M Rosati

Assistant Examiner — John A Voytek

(57) **CLAIM**

The ornamental design for an aroma diffuser, as shown and described.

DESCRIPTION

FIG. 1 is a front elevational view of an aroma diffuser showing my new design;
FIG. 2 is a rear elevational view thereof;
FIG. 3 is a left side view thereof;
FIG. 4 is a right side view thereof;
FIG. 5 is a top plan view thereof;
FIG. 6 is a bottom plan view thereof;
FIG. 7 is a first perspective view thereof; and,
FIG. 8 is a second perspective view thereof.
The broken lines in the drawings illustrate portions of the aroma diffuser which form no part of the claimed design.

1 Claim, 8 Drawing Sheets

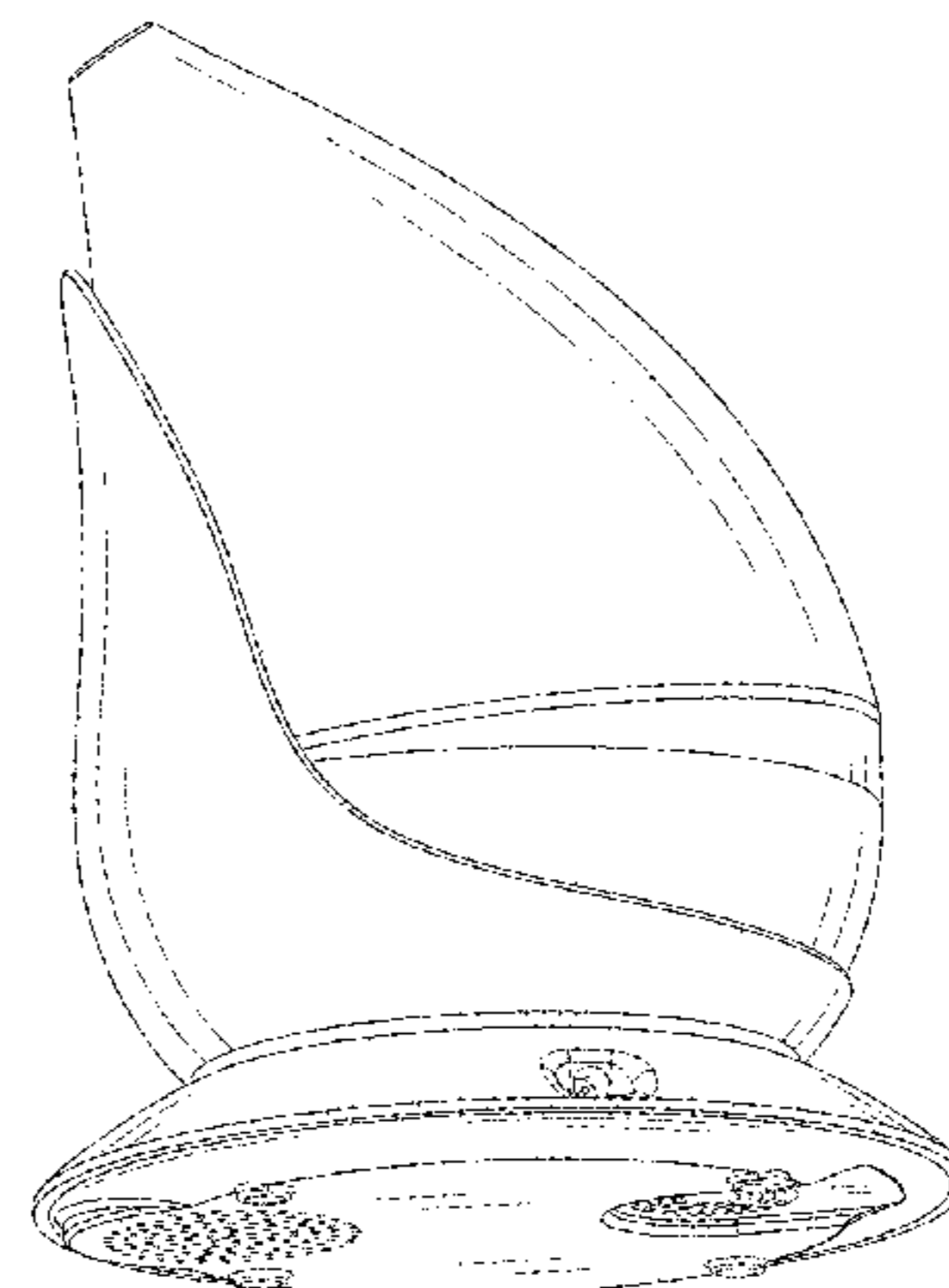
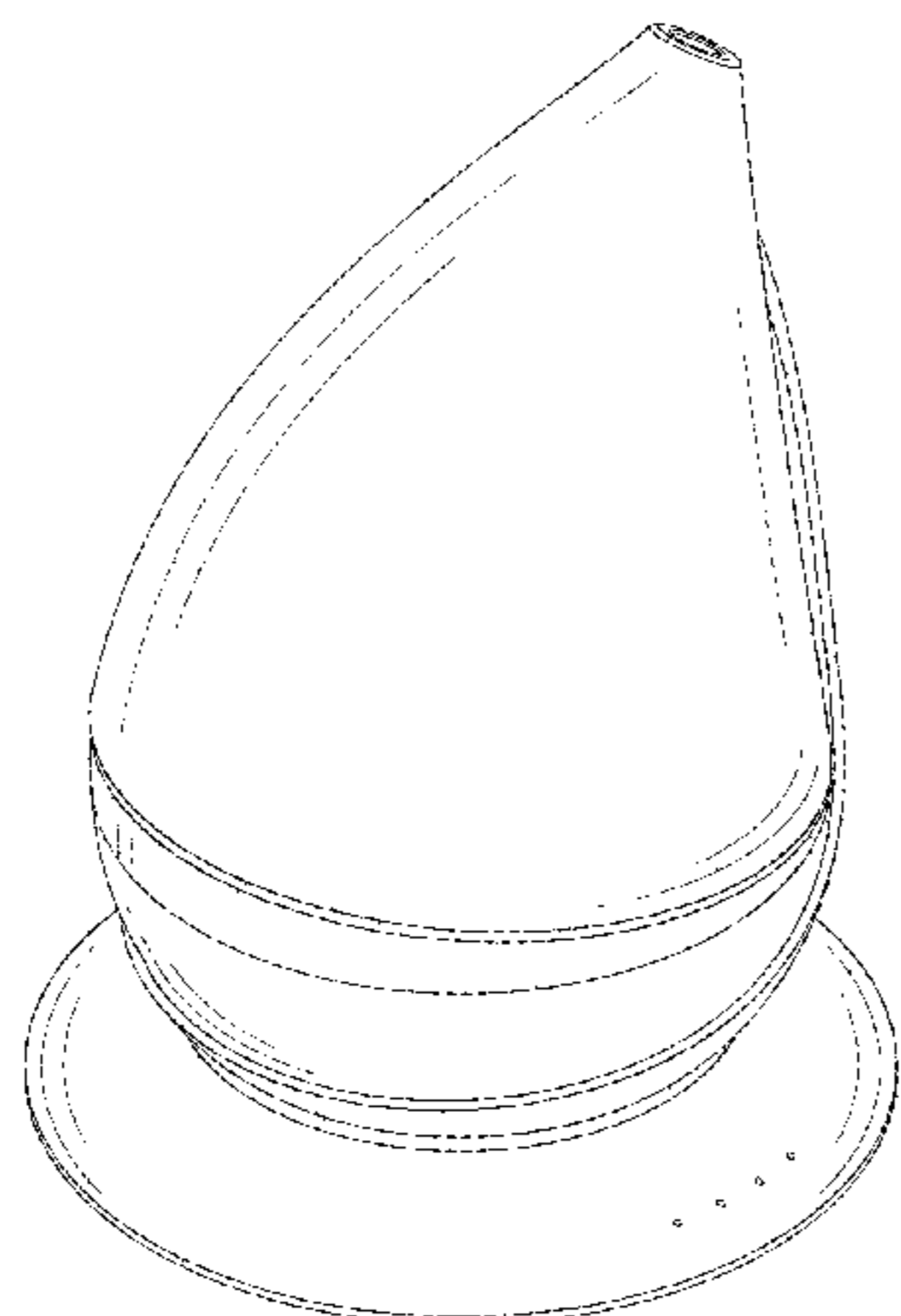

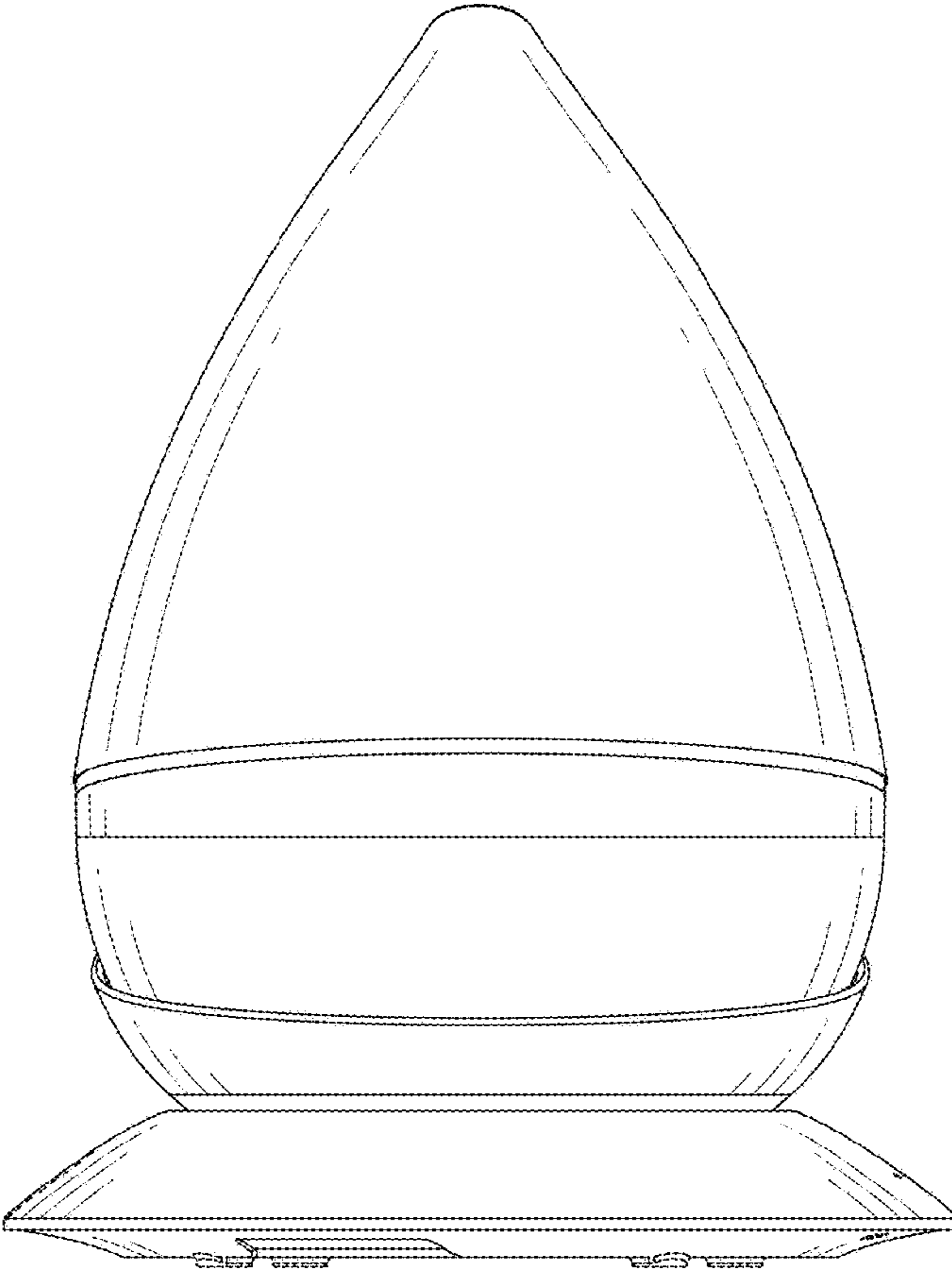

FIG.1

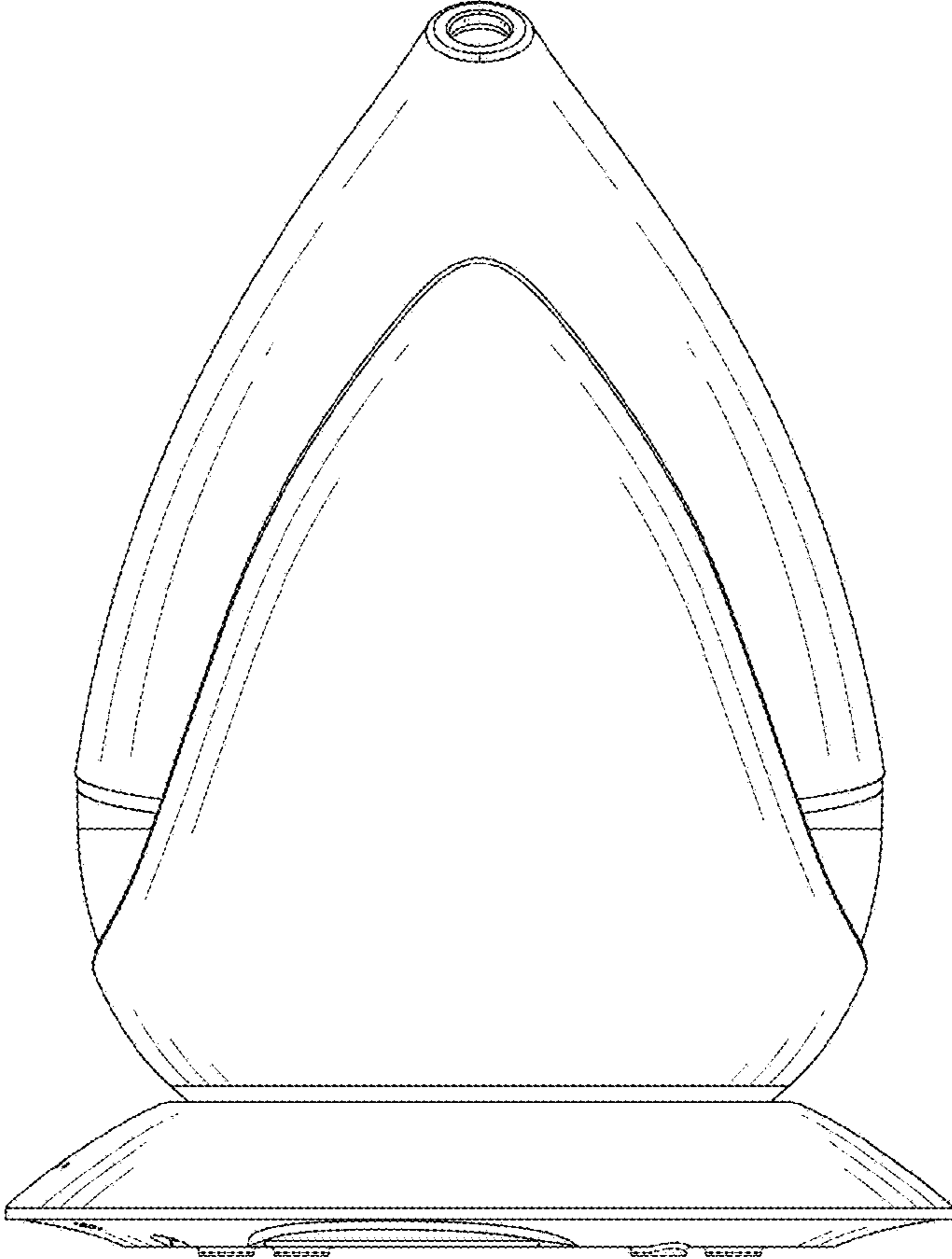

FIG.2

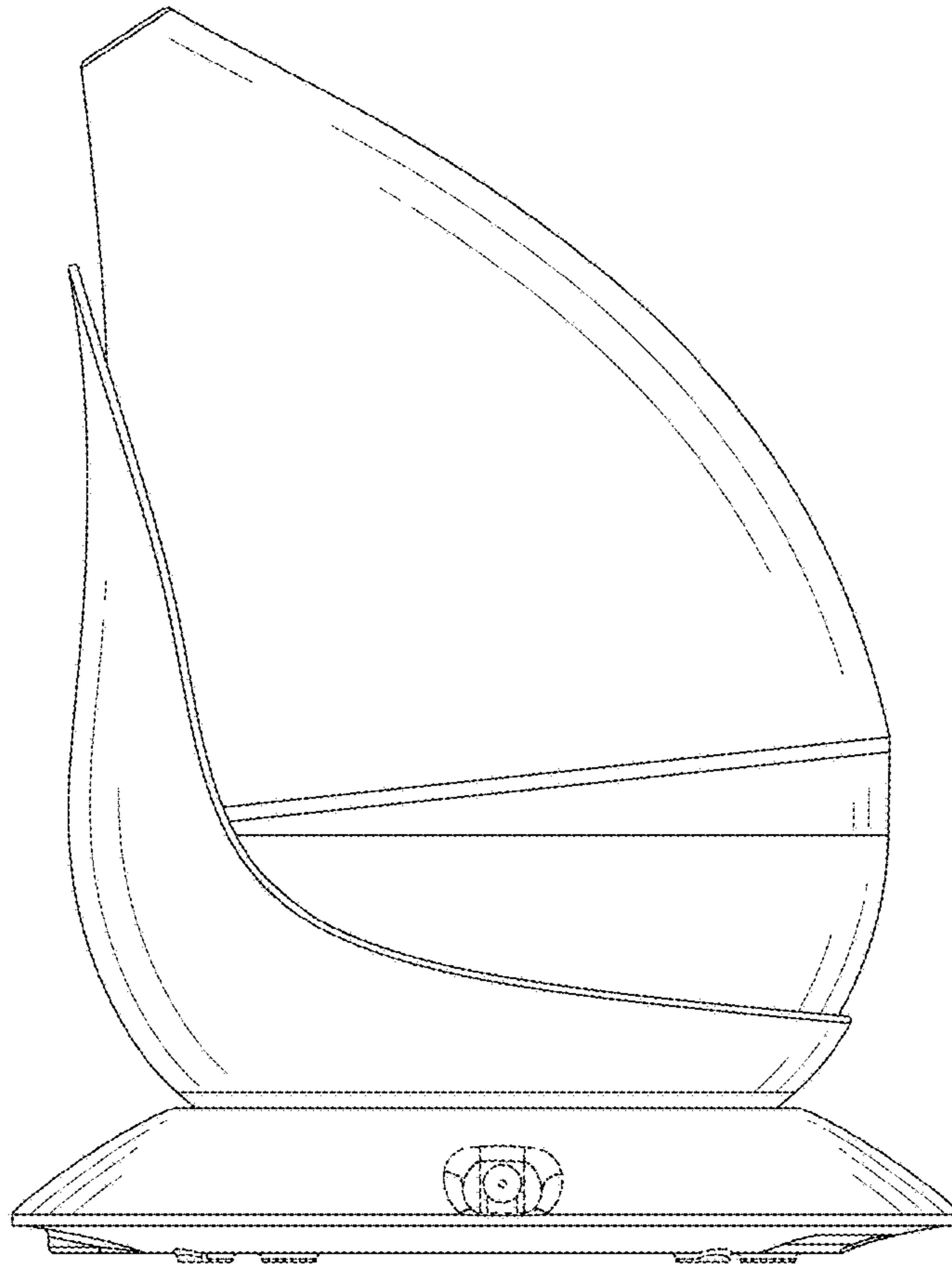

FIG. 3

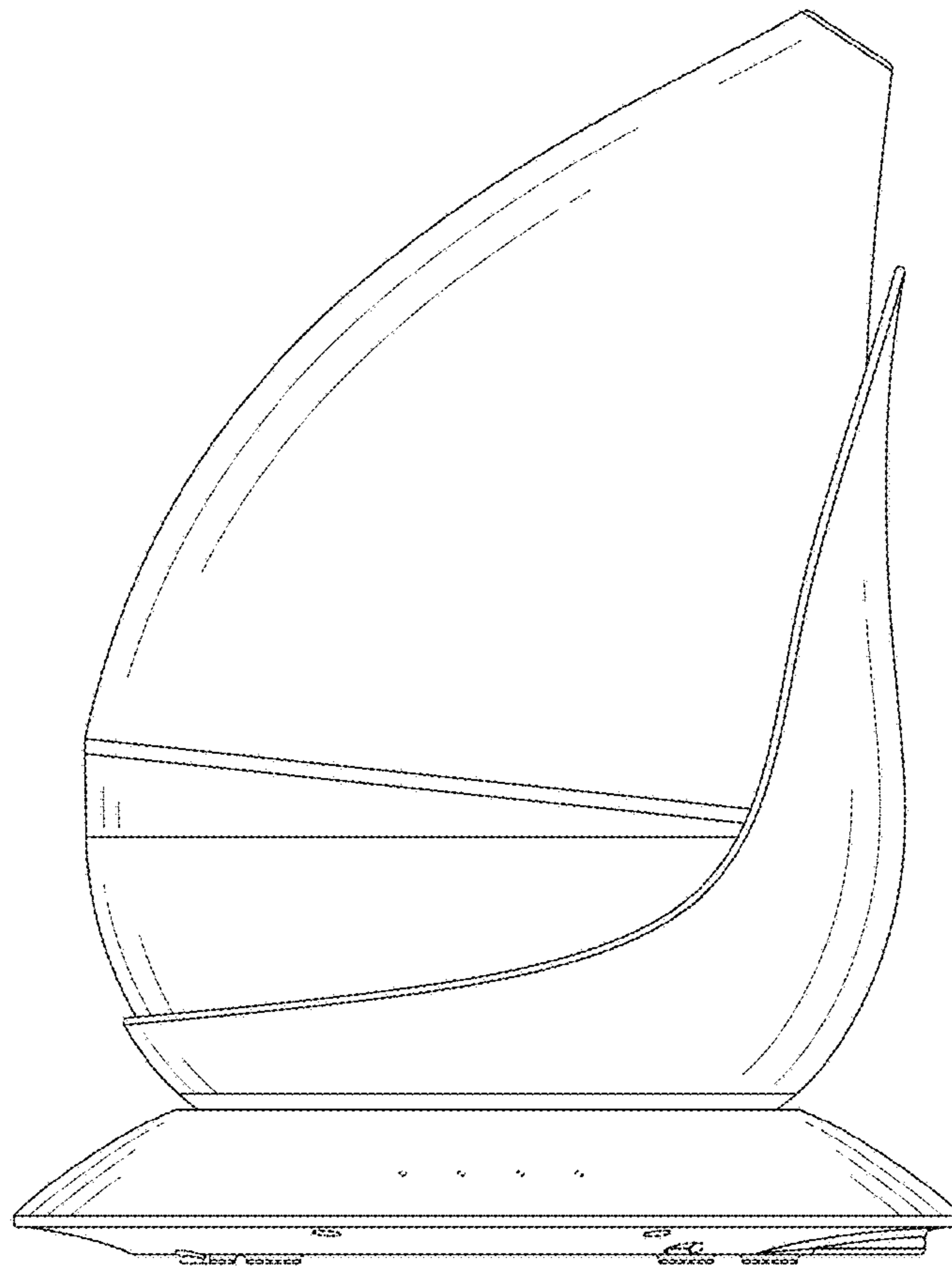

FIG.4

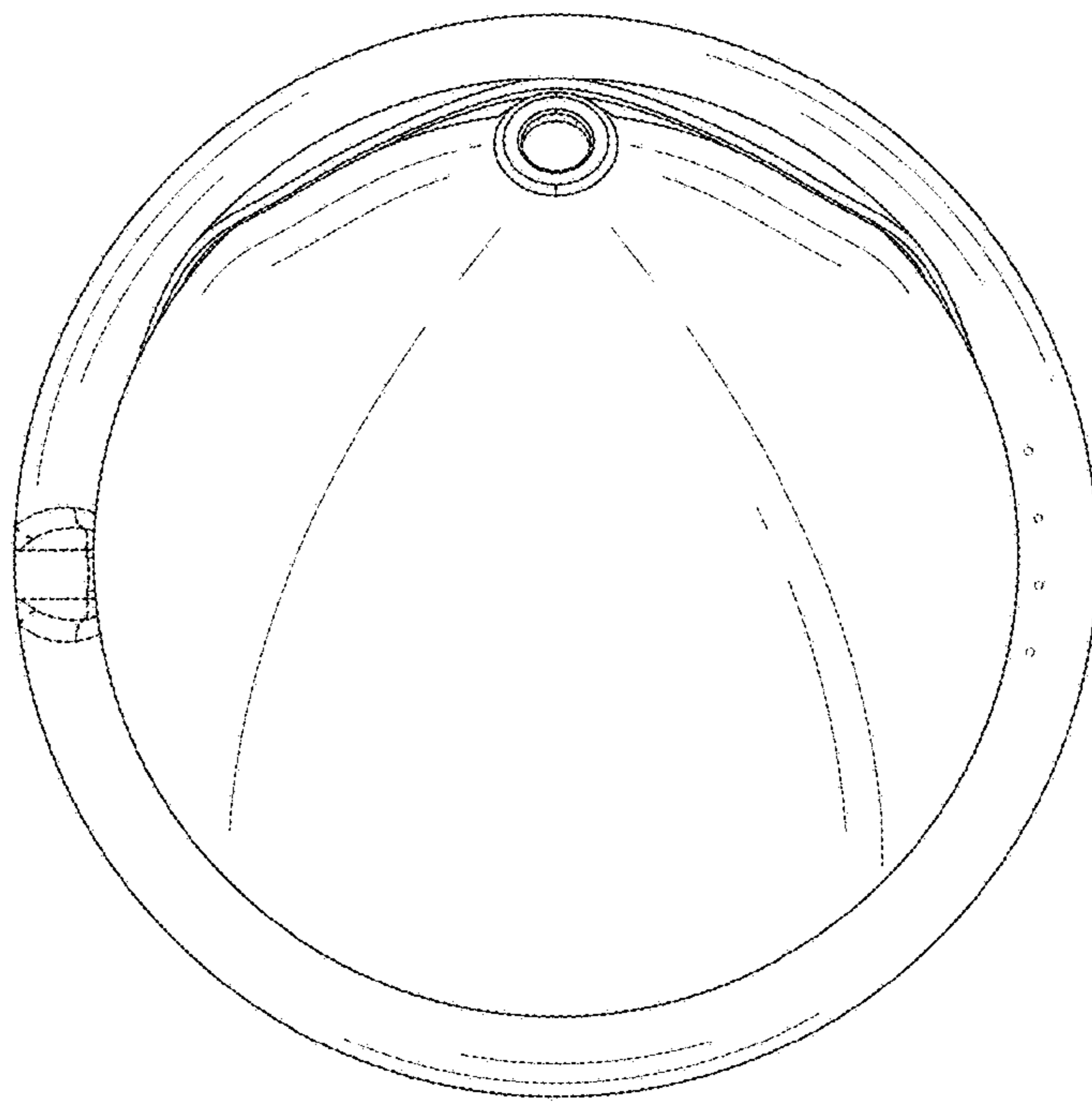

FIG.5

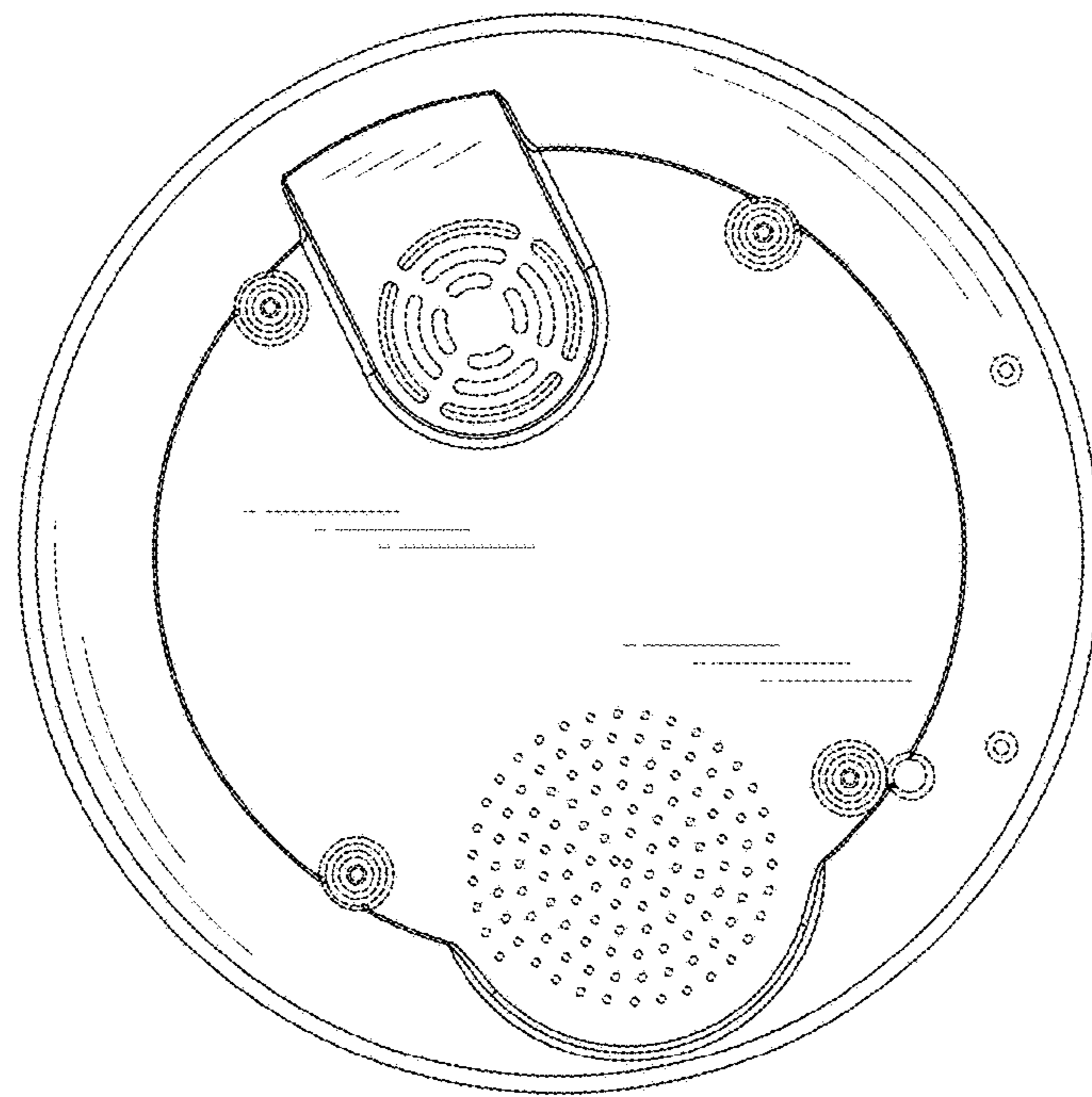

FIG.6

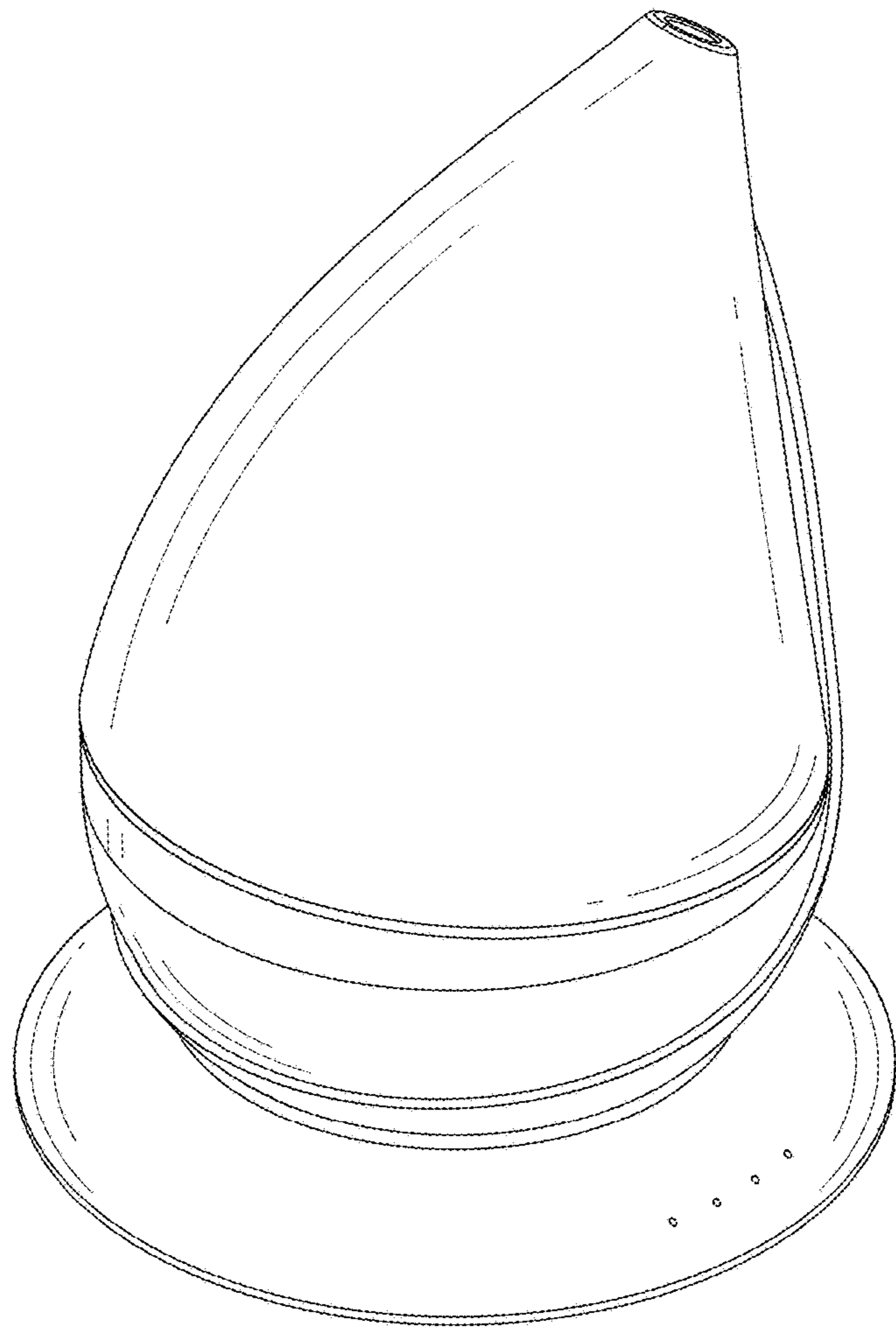

FIG. 7

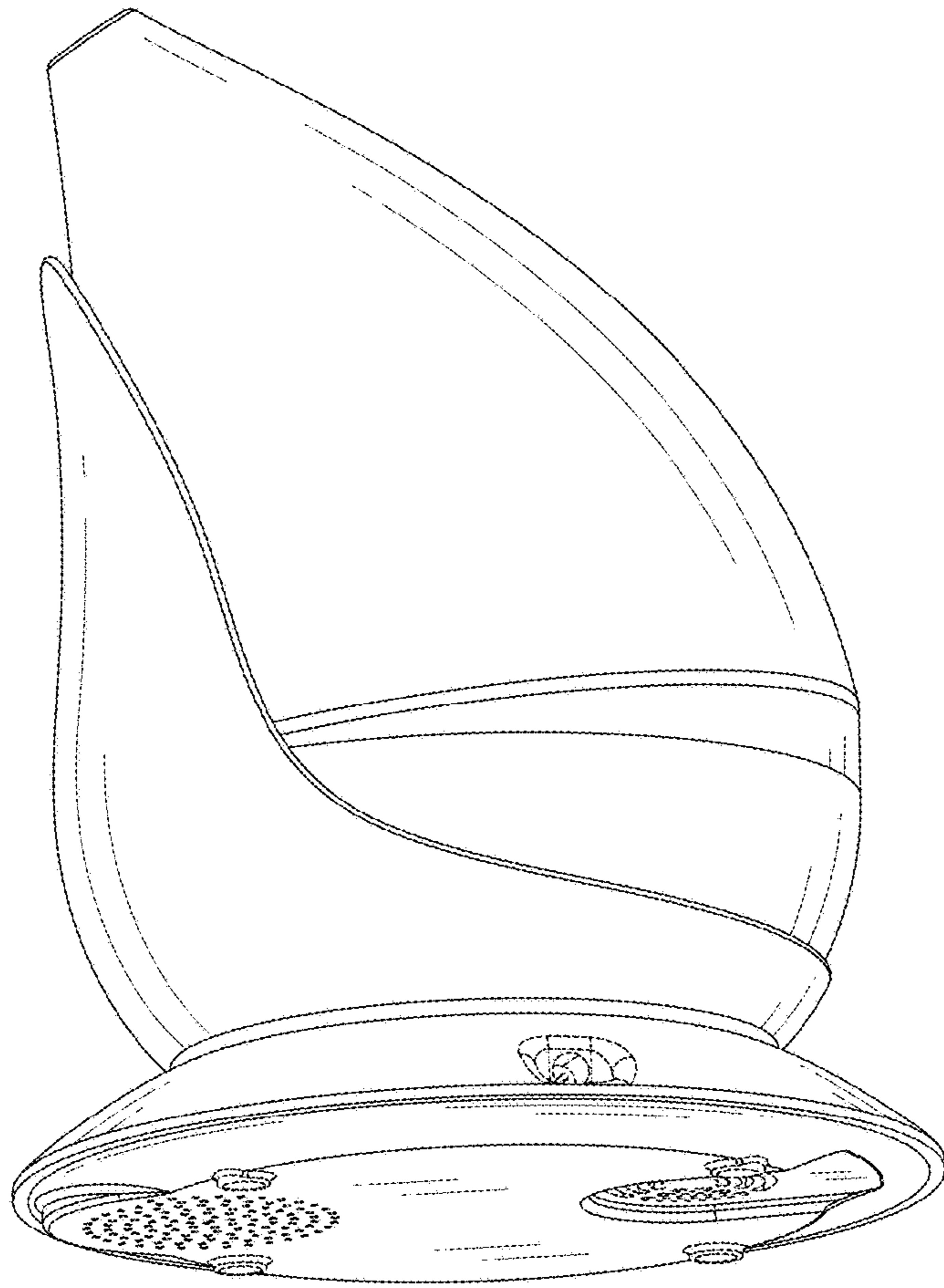

FIG.8