



US00D865933S

(12) **United States Design Patent** (10) **Patent No.:** **US D865,933 S**
Oh (45) **Date of Patent:** **** Nov. 5, 2019**

(54) **AIR CLEANER**

(71) Applicant: **TORNADO SYSTEMS CO., LTD.**,
Gyeonggi-Do (KR)

(72) Inventor: **Hee Bum Oh**, Yongin-si (KR)

(**) Term: **15 Years**

(21) Appl. No.: **35/505,281**

(22) Filed: **Jan. 5, 2018**

(80) **Hague Agreement Data**

Int. Filing Date: **Jan. 5, 2018**

Int. Reg. No.: **DM/101004**

Int. Reg. Date: **Jan. 5, 2018**

Int. Reg. Pub. Date: **Jul. 13, 2018**

(51) **LOC (12) Cl.** **23-02**

(52) **U.S. Cl.**
USPC **D23/364**

(58) **Field of Classification Search**
USPC D11/143-145, 152-154; D23/355, 356,
D23/359, 370, 386
CPC F24F 11/46; F24F 11/58
See application file for complete search history.

(56) **References Cited**

U.S. PATENT DOCUMENTS

| | | | |
|--------------|--------|----------------|---------|
| D621,020 S * | 8/2010 | Lehaneur | D23/364 |
| D732,654 S * | 6/2015 | Hsiao | D23/366 |
| D766,127 S * | 9/2016 | Siegel | D11/152 |
| D818,099 S * | 5/2018 | Cho | D23/364 |
| D823,451 S * | 7/2018 | Ganis | D23/364 |

* cited by examiner

Primary Examiner — Khawaja Anwar

(57) **CLAIM**

The ornamental design for an air cleaner, as shown and described.

DESCRIPTION

1. Air cleaner

FIG. 1.1 is a perspective view of the invention;

FIG. 1.2 is a front view thereof;

FIG. 1.3 is a rear view thereof;

FIG. 1.4 a top plan view thereof;

FIG. 1.5 a bottom plan view thereof;

FIG. 1.6 a left side view thereof; and

FIG. 1.7 a right side view thereof.

The broken lines showing of a bottom surface in FIG. 1.5 are for an illustration purpose and form no part of the claimed design.

1 Claim, 7 Drawing Sheets

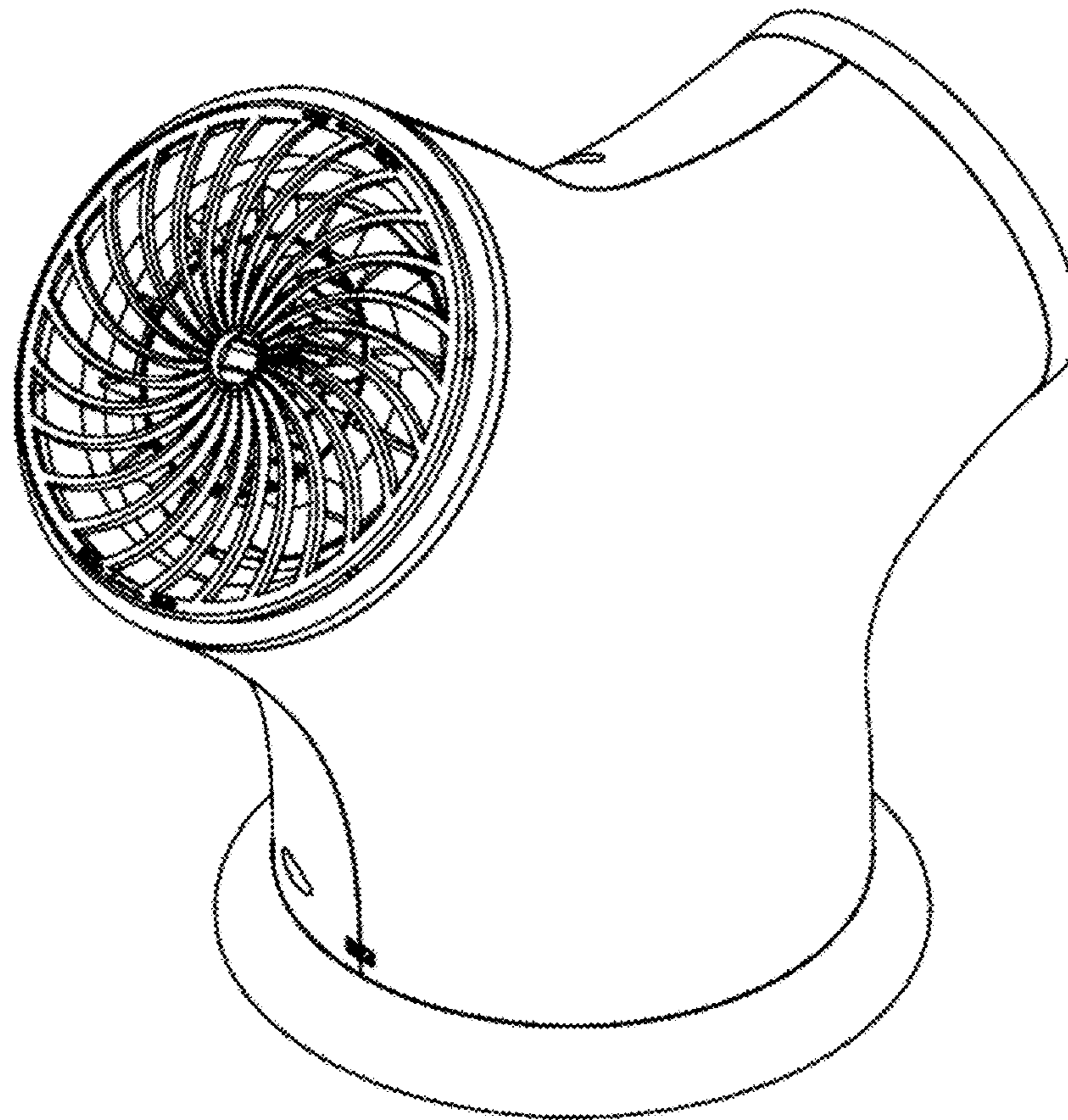

1.1

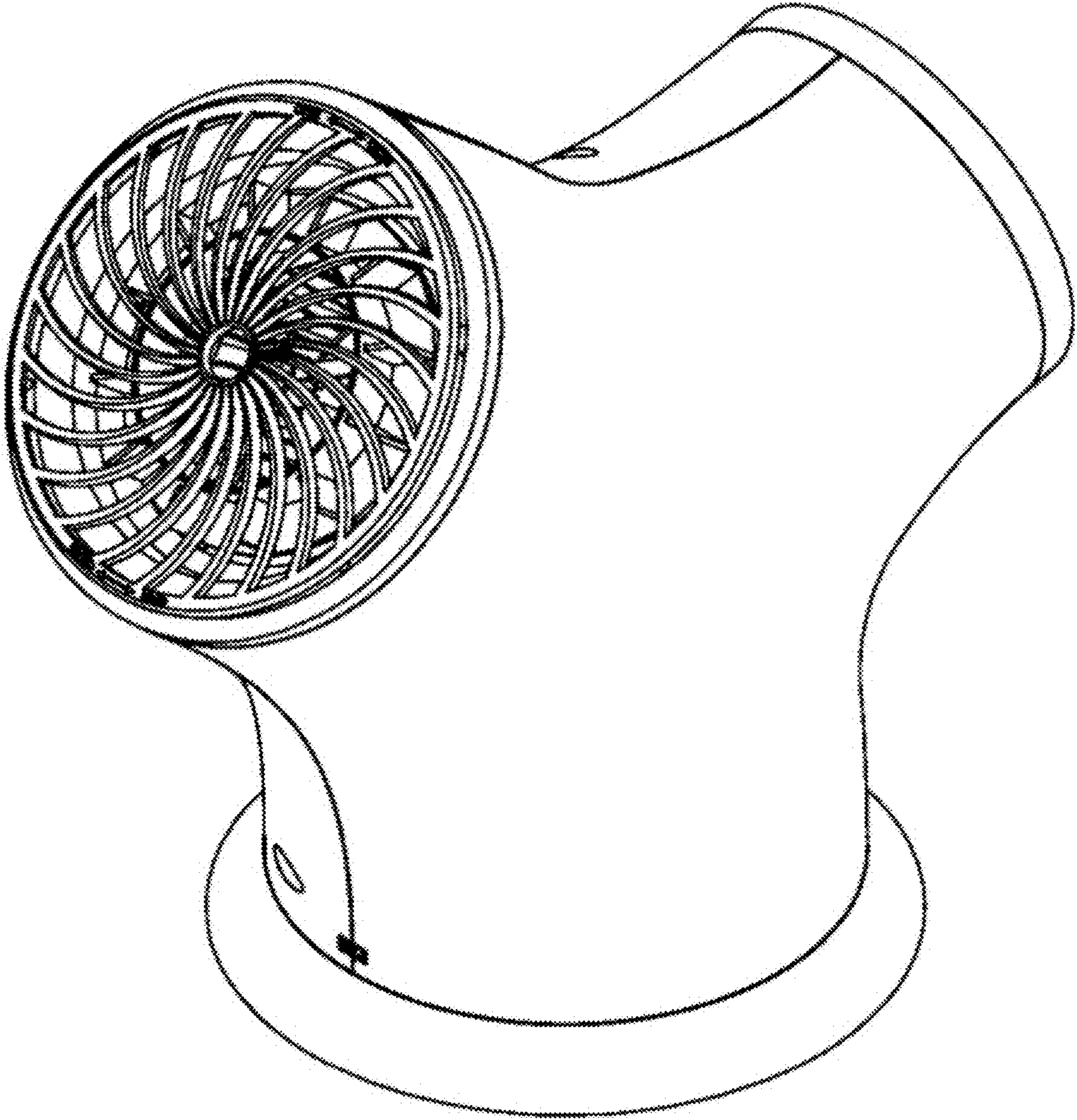

1.2

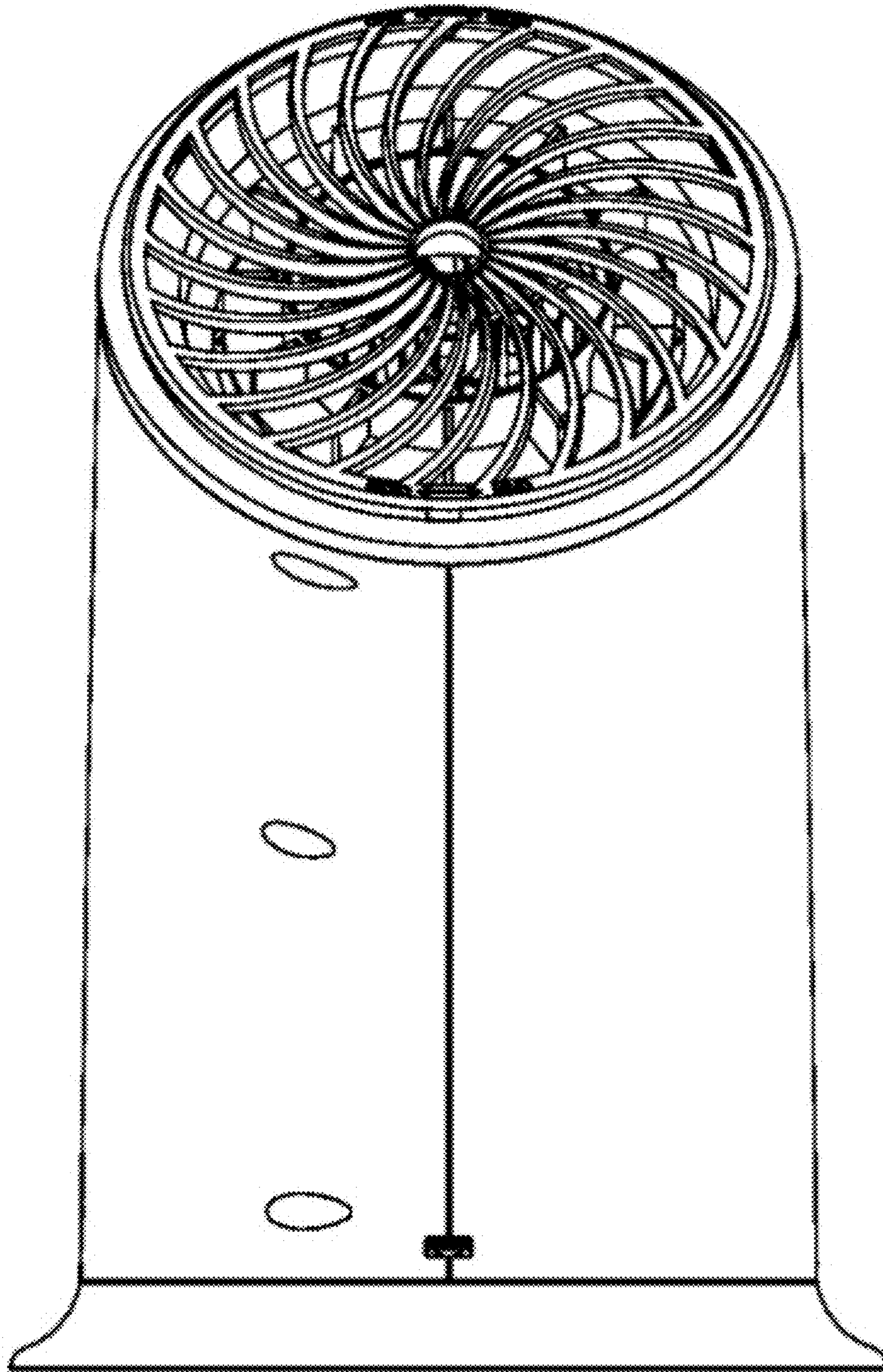

1.3

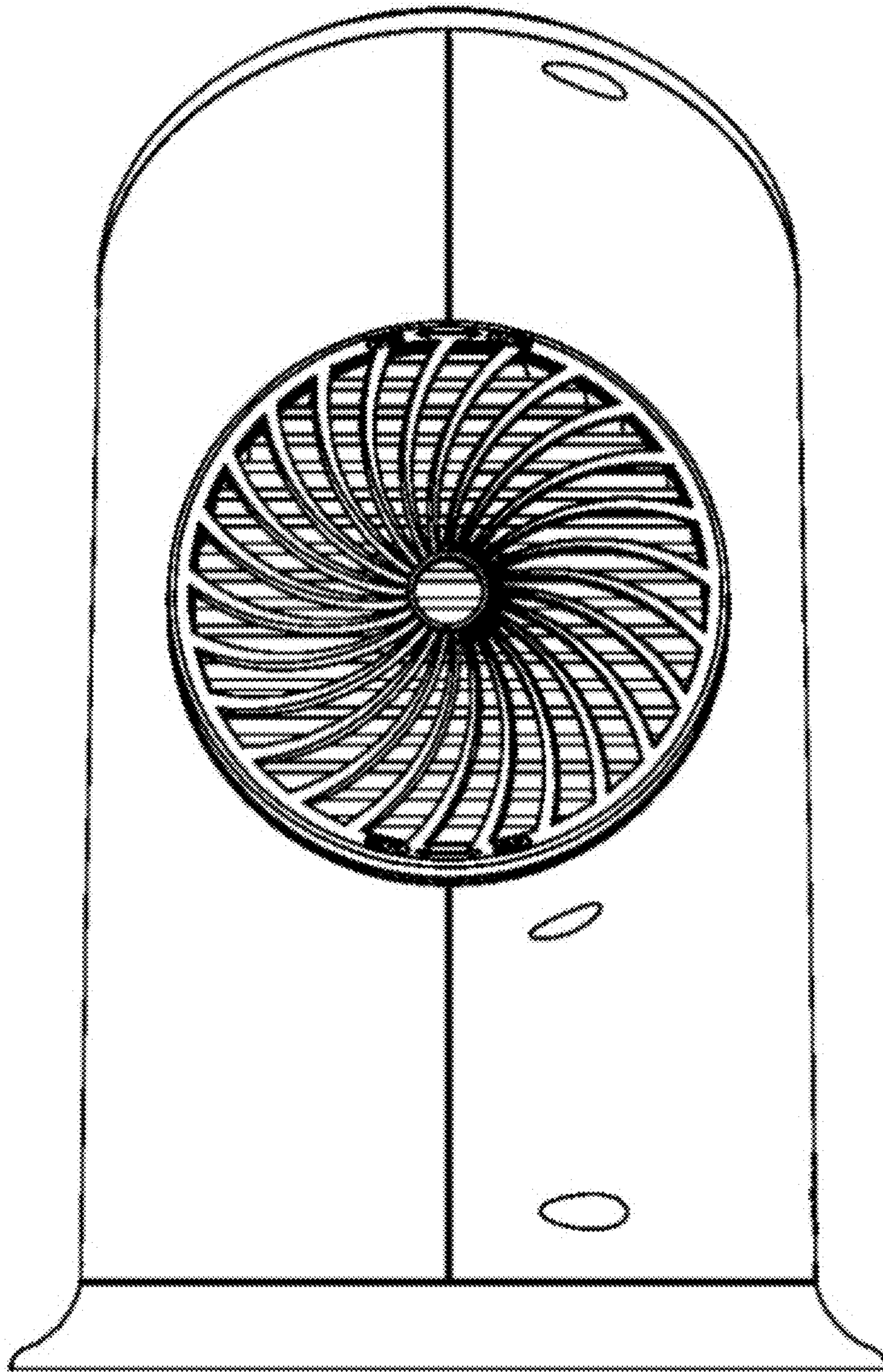

1.4

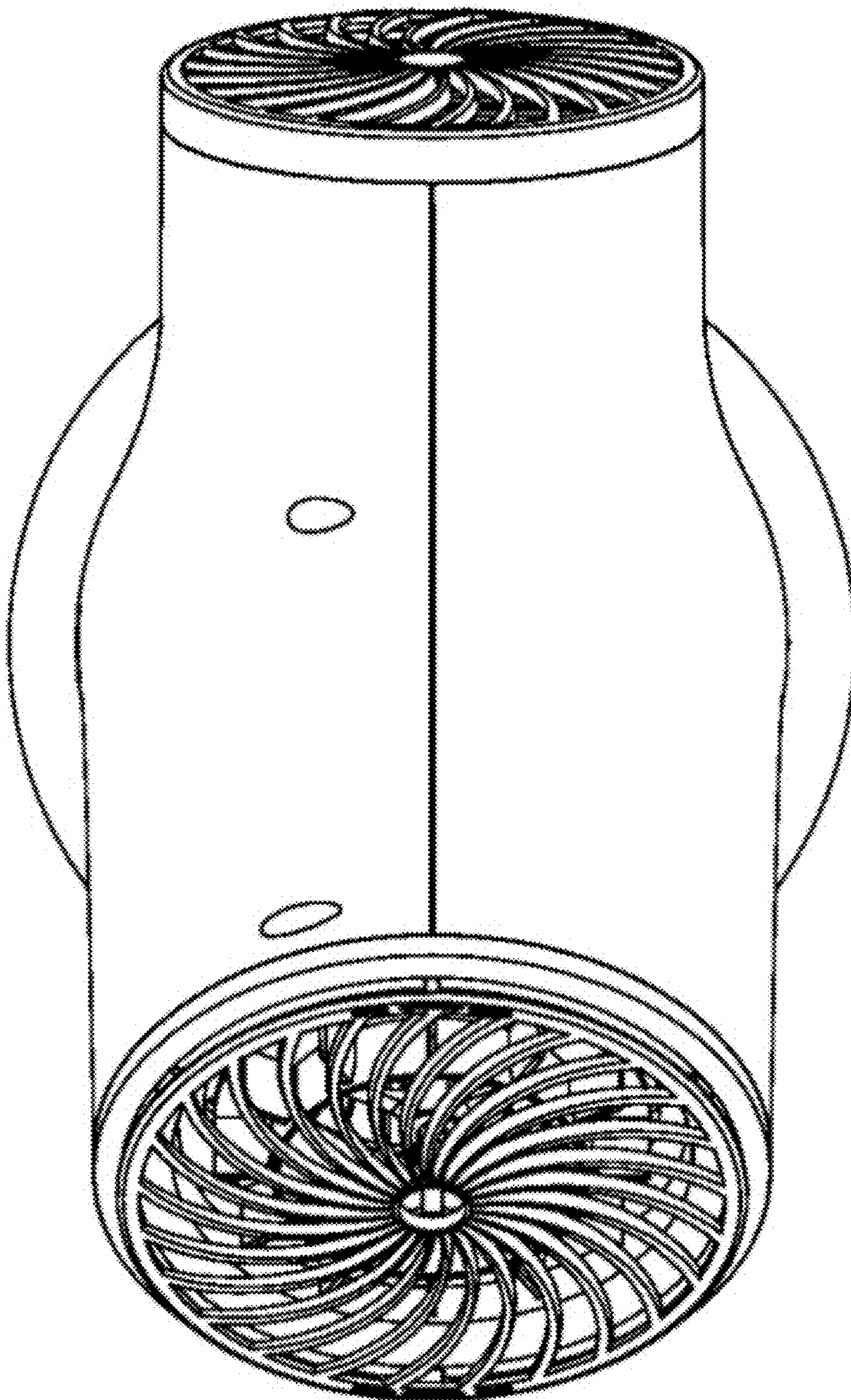
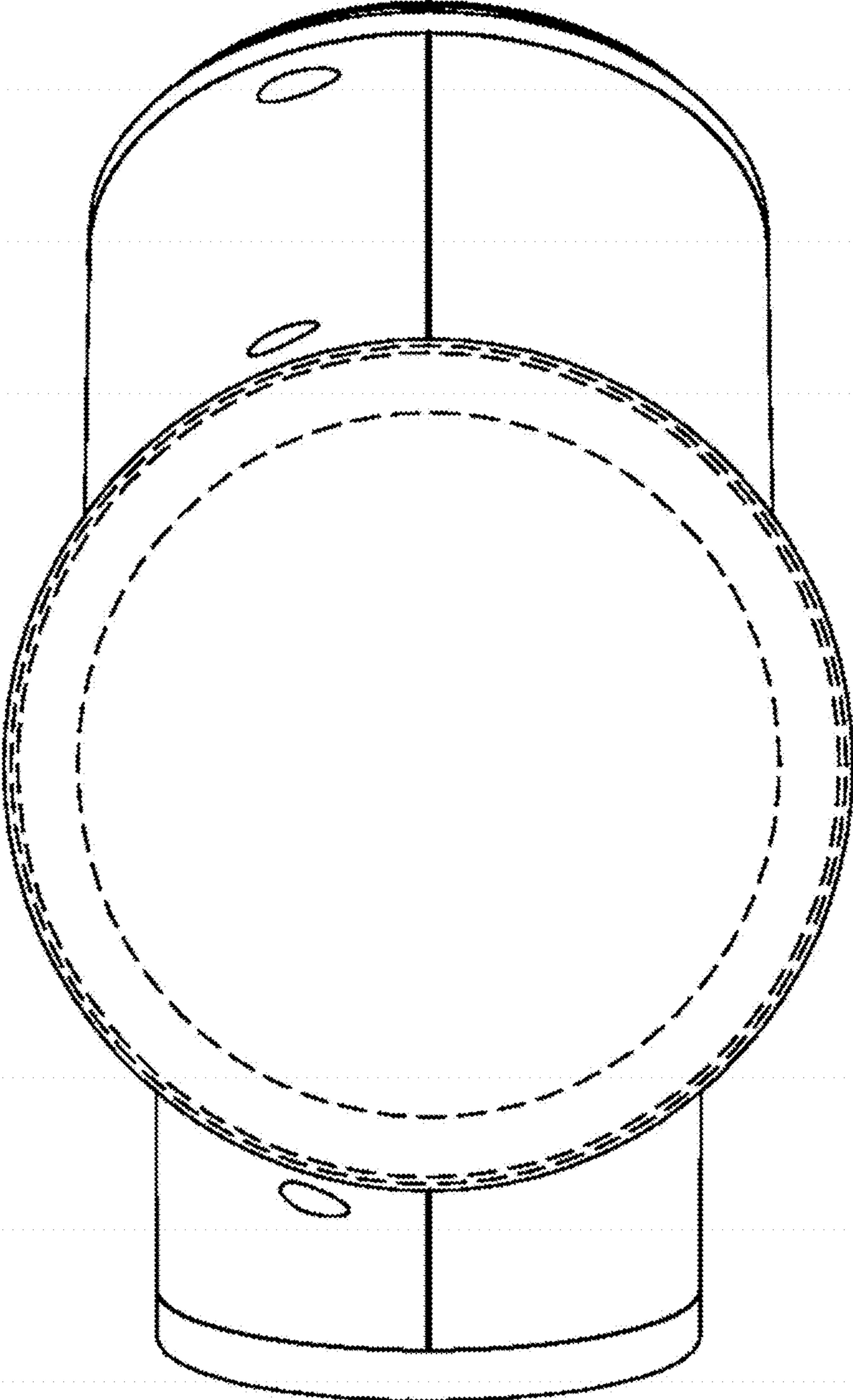
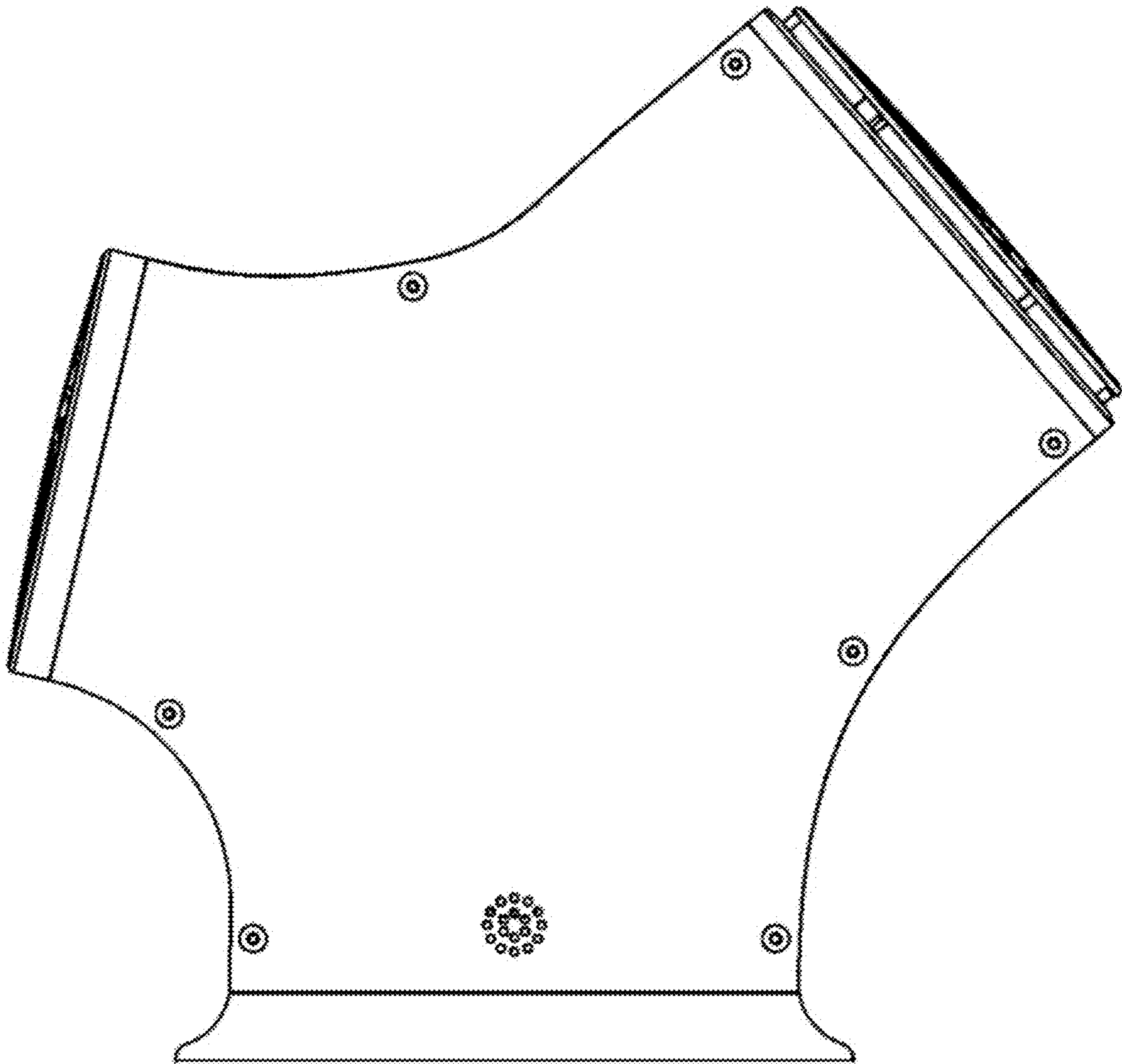

FIG. 1.5



1.6



1.7

