



US00D865904S

(12) **United States Design Patent** (10) **Patent No.:** **US D865,904 S**
Norton et al. (45) **Date of Patent:** **** Nov. 5, 2019**

(54) **WEIGHTED KEEL FOR A BUOYANT HUNTING DECOY**

- (71) Applicant: **Flambeau, Inc.**, Baraboo, WI (US)
- (72) Inventors: **Donald Kim Norton**, Chardon, OH (US); **James A. Raisbeck**, Middleton, WI (US); **Mark E. Cipolla**, Chardon, OH (US)
- (73) Assignee: **Flambeau, Inc.**, Baraboo, WI (US)
- (**) Term: **15 Years**
- (21) Appl. No.: **29/649,276**
- (22) Filed: **May 29, 2018**
- (51) **LOC (12) Cl.** **22-05**
- (52) **U.S. Cl.**
USPC **D22/125**
- (58) **Field of Classification Search**
USPC D22/125, 199; 43/3
CPC A01M 31/00; A01M 31/06
See application file for complete search history.

(56) **References Cited**

U.S. PATENT DOCUMENTS

- 2,816,383 A * 12/1957 Locher A01M 31/06
43/3
- D230,270 S * 2/1974 Gagnon 43/3
- 4,923,427 A 5/1990 Roland
- 5,832,650 A * 11/1998 Franceschini A01M 31/06
43/3

(Continued)

Primary Examiner — Catherine R Oliver-Garcia
(74) *Attorney, Agent, or Firm* — Quarles & Brady LLP

(57) **CLAIM**

The ornamental design for a weighted keel for a buoyant hunting decoy, as shown and described.

DESCRIPTION

FIG. 1 is an isometric view of a bottom, front, and left side of an ornamental design for a weighted keel for a buoyant hunting decoy;

FIG. 2 is a front elevational view of the weighted keel of FIG. 1;

FIG. 3 is a rear elevational view of the weighted keel of FIG. 1;

FIG. 4 is a right side elevational view of the weighted keel of FIG. 1;

FIG. 5 is a left side elevational view of the weighted keel of FIG. 1;

FIG. 6 is a top plan view of the weighted keel of FIG. 1;

FIG. 7 is a bottom plan view of the weighted keel of FIG. 1;

FIG. 8 is an isometric view of a bottom, front, and left of the weighted keel of FIG. 1 depicting the positioning of the weighted keel of FIG. 1 relative to a body of the buoyant hunting decoy;

FIG. 9 is an isometric view of a bottom, front, and left side of another embodiment of an ornamental design for a weighted keel for a buoyant hunting decoy;

FIG. 10 is a front elevational view of the weighted keel of FIG. 9;

FIG. 11 is a rear elevational view of the weighted keel of FIG. 9;

FIG. 12 is a right side elevational view of the weighted keel of FIG. 9;

FIG. 13 is a left side elevational view of the weighted keel of FIG. 9;

FIG. 14 is a top plan view of the weighted keel of FIG. 9; and,

FIG. 15 is a bottom plan view of the weighted keel of FIG. 9.

The dash-dash-dash broken lines are included for the purpose of illustrating portions of the weighted keel and form no part of the claimed design. The dash-dot-dash-dot broken lines define boundaries of the claimed design and form no part of the claimed design. FIGS. 6 and 14 form no part of the claimed design.

1 Claim, 11 Drawing Sheets

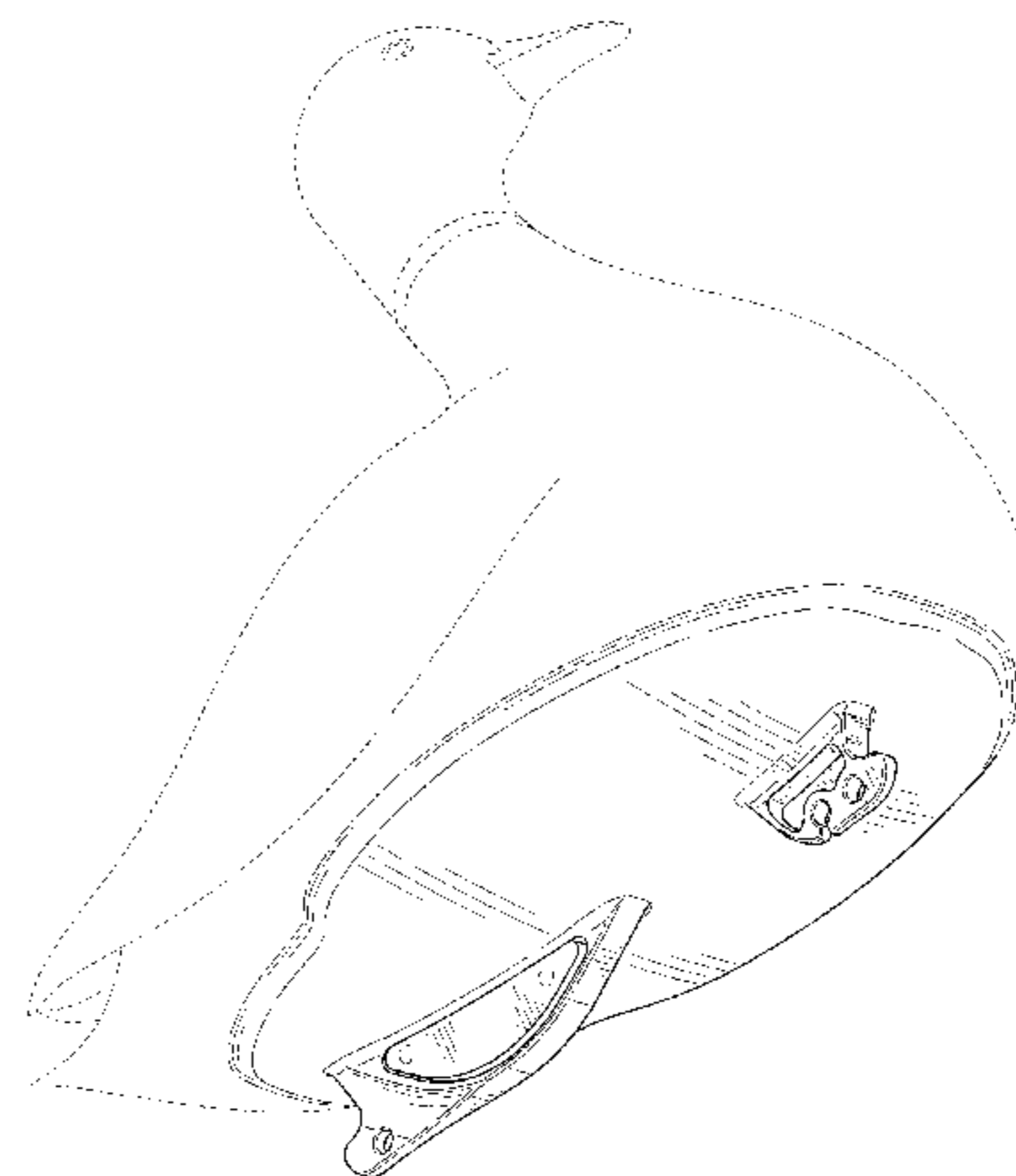
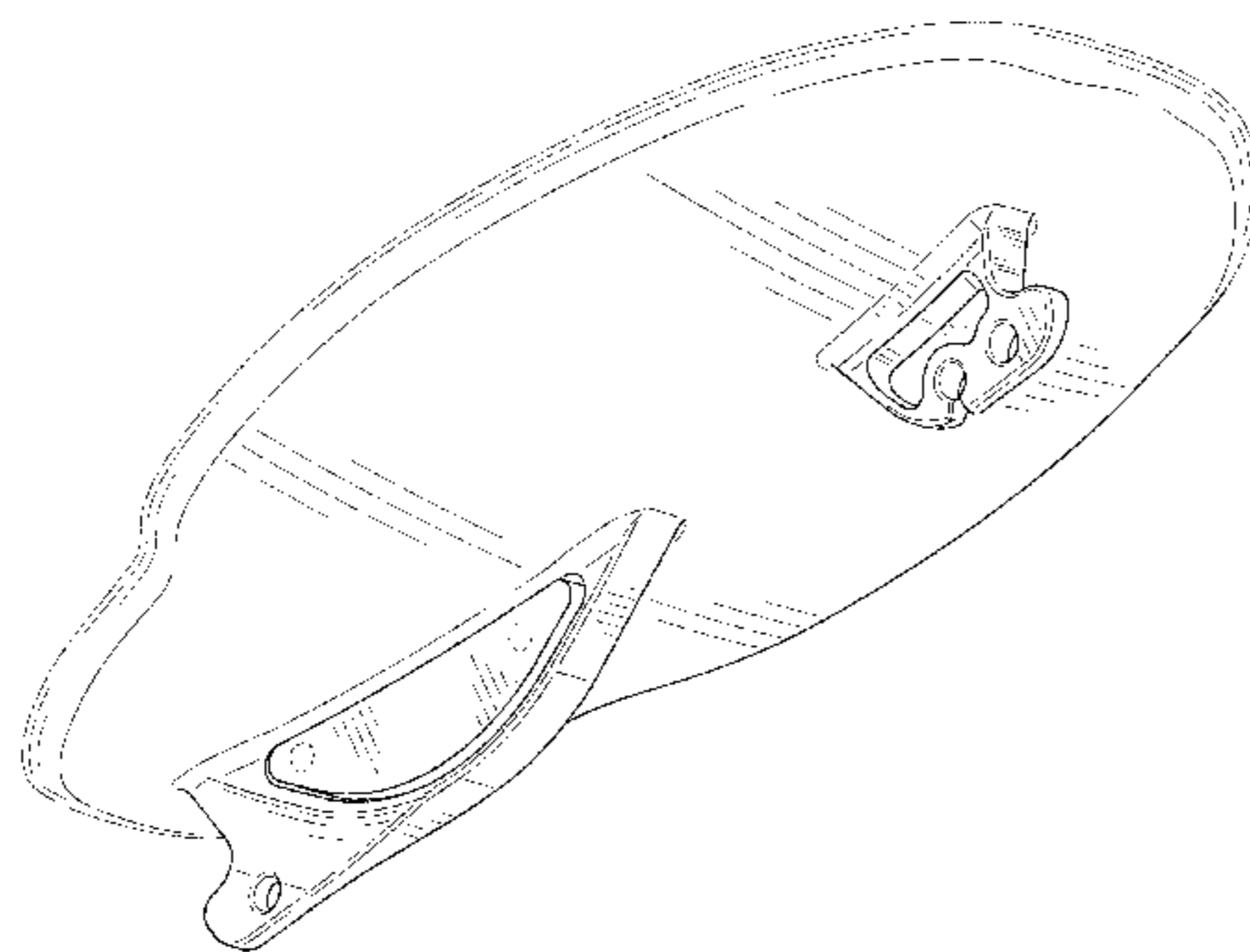

(56)

References Cited

U.S. PATENT DOCUMENTS

D501,526 S * 2/2005 Matthews D22/125
D509,556 S * 9/2005 Matthews D22/125
D511,557 S * 11/2005 Matthews D22/125
D711,485 S 8/2014 Thompson
8,894,460 B1 11/2014 Thompson
9,352,239 B2 5/2016 Hohns et al.
9,474,983 B2 10/2016 Hohns et al.
D774,161 S * 12/2016 Stirling D22/125
D820,378 S * 6/2018 Enmeier D22/125
2003/0061755 A1 * 4/2003 McGhghy A01M 31/06
43/3
2006/0123688 A1 6/2006 Box et al.
2009/0126253 A1 * 5/2009 Wood A01M 31/06
43/3
2017/0007934 A1 1/2017 Hohns et al.

* cited by examiner

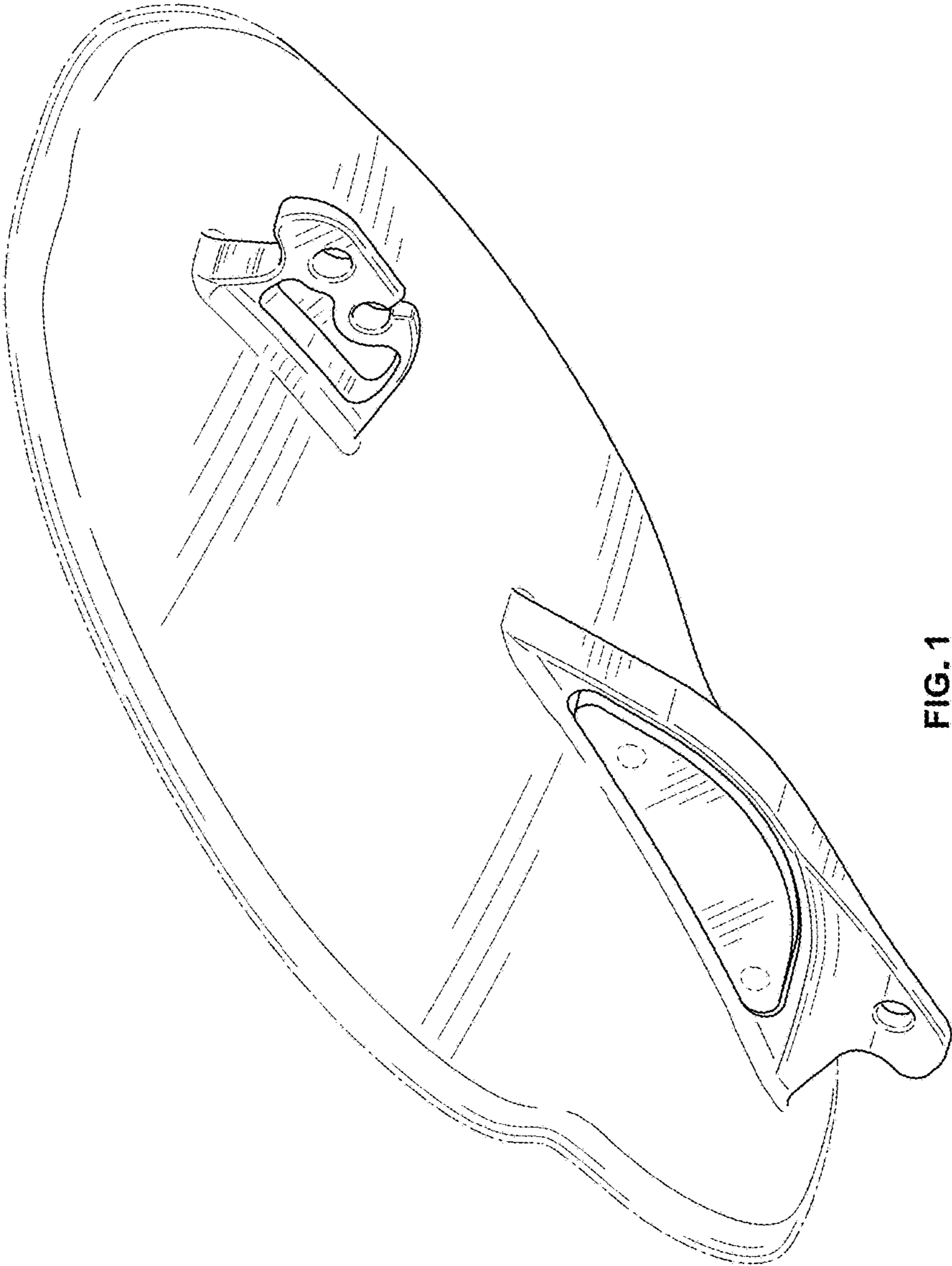

FIG. 1

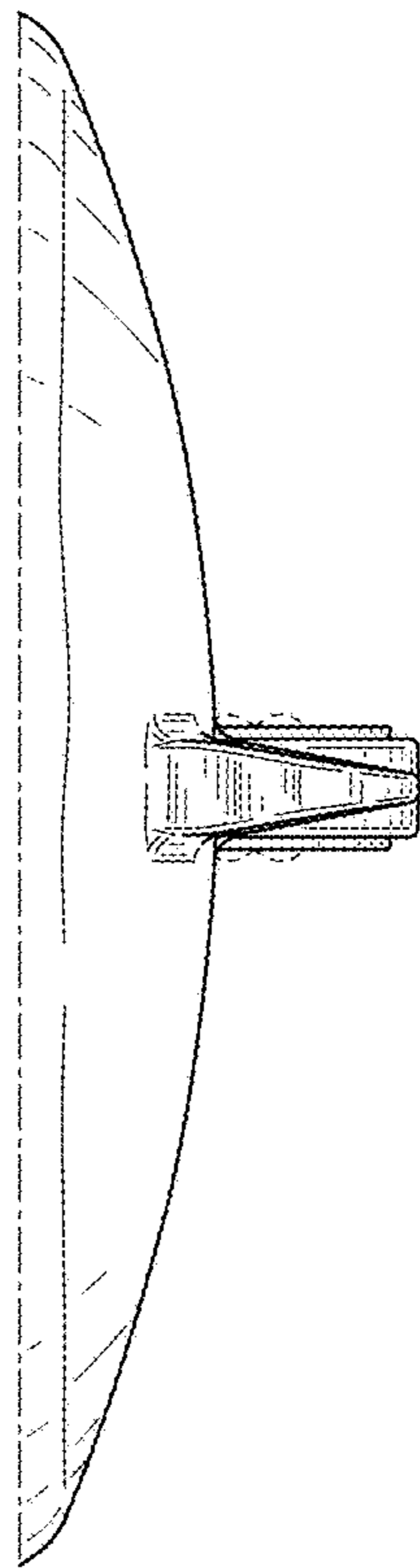

FIG. 2

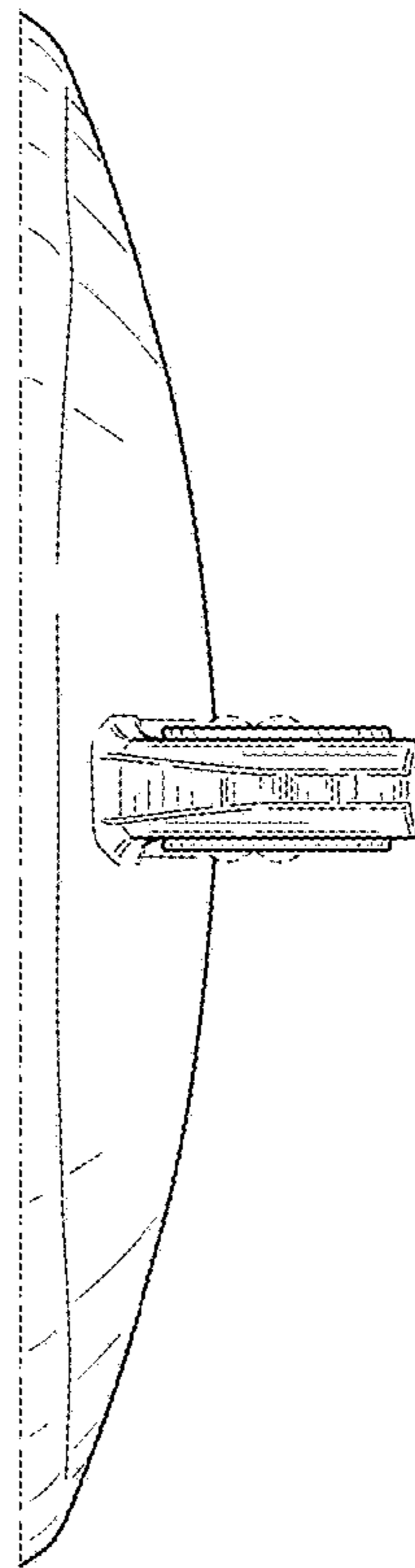

FIG. 3

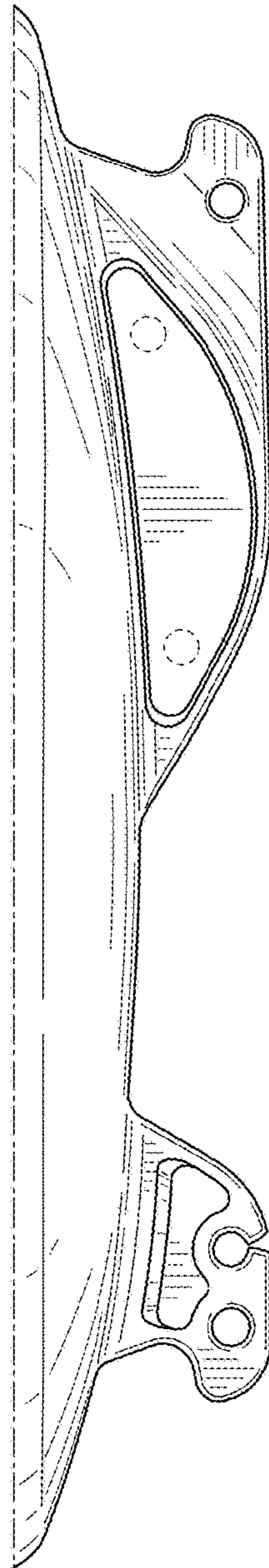

FIG. 4

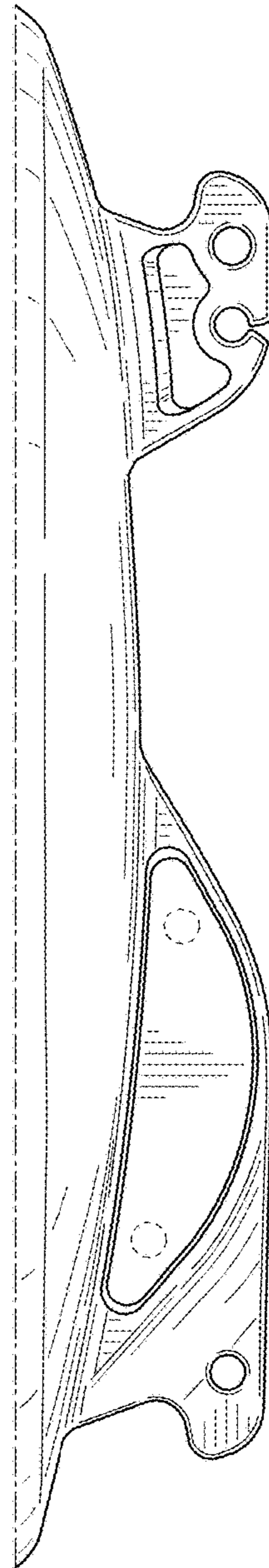

FIG. 5

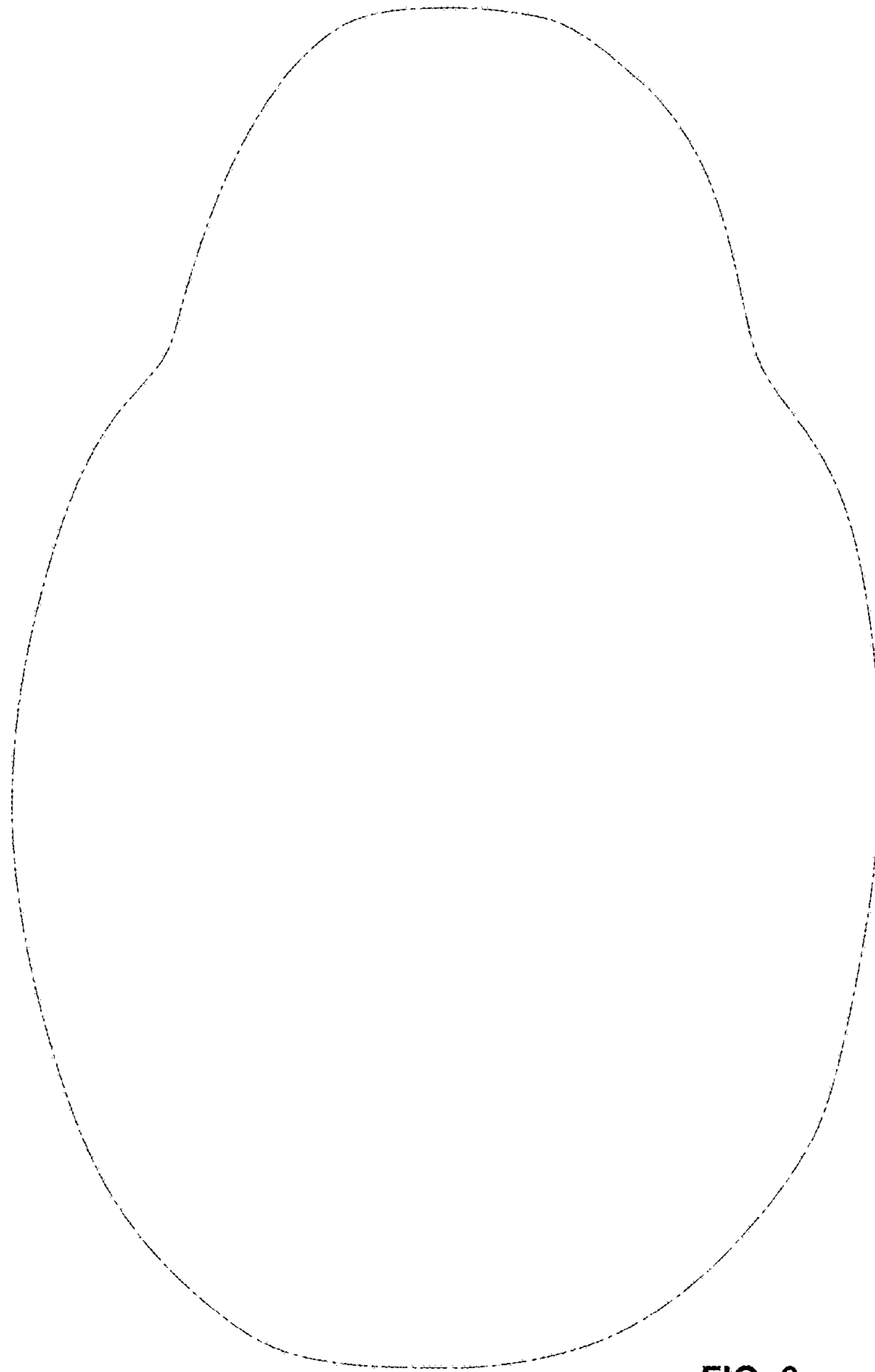

FIG. 6

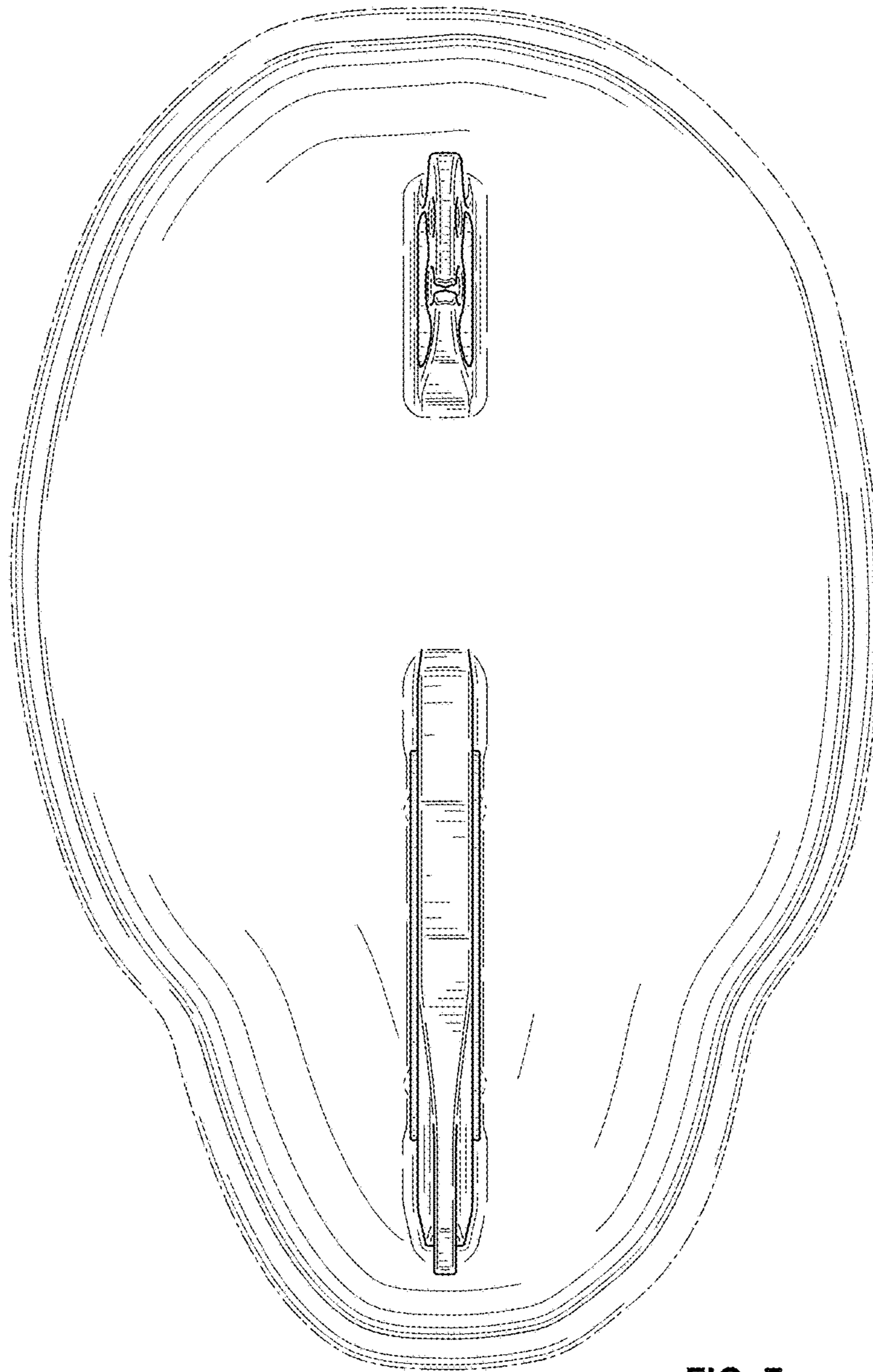

FIG. 7

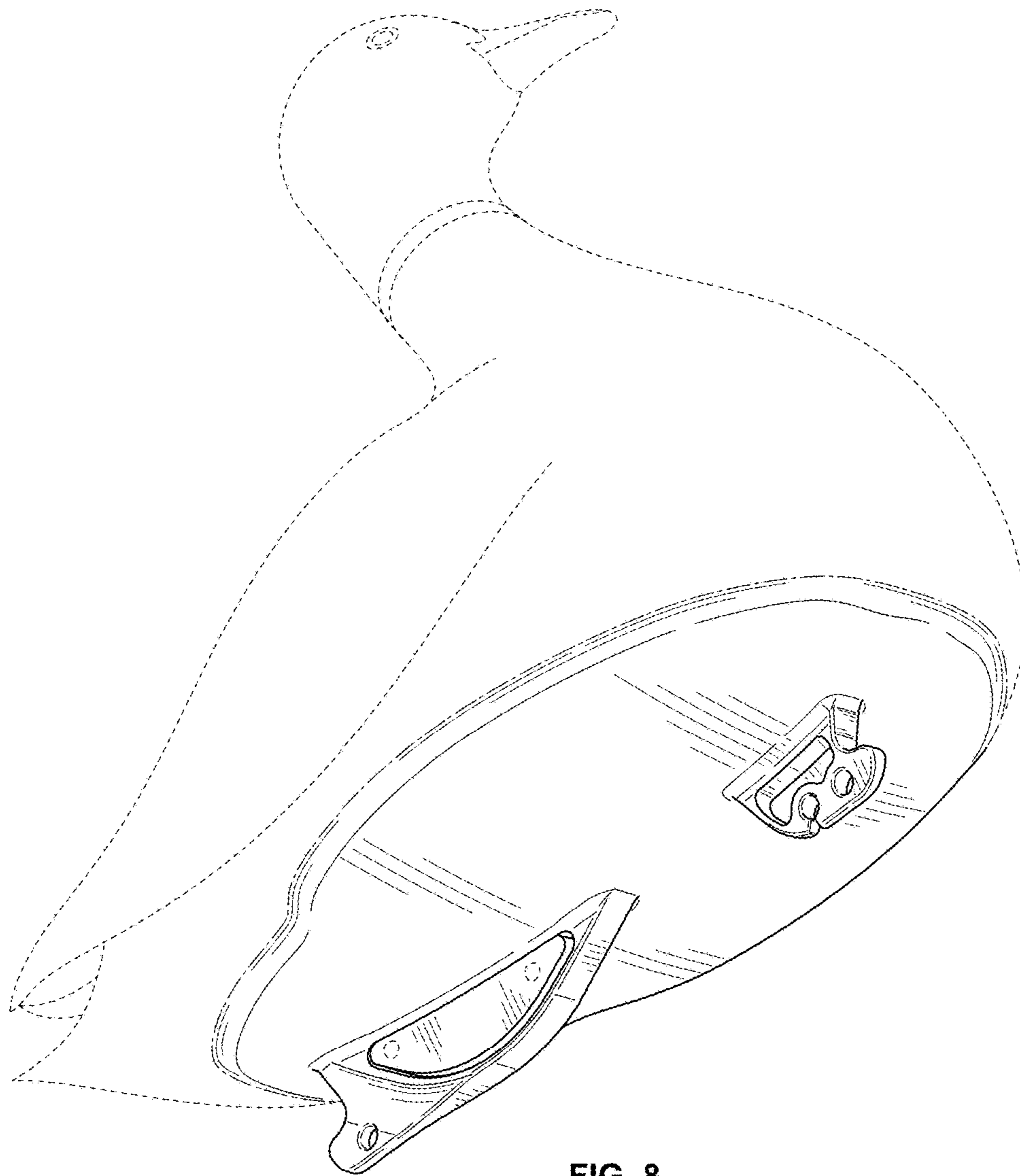

FIG. 8

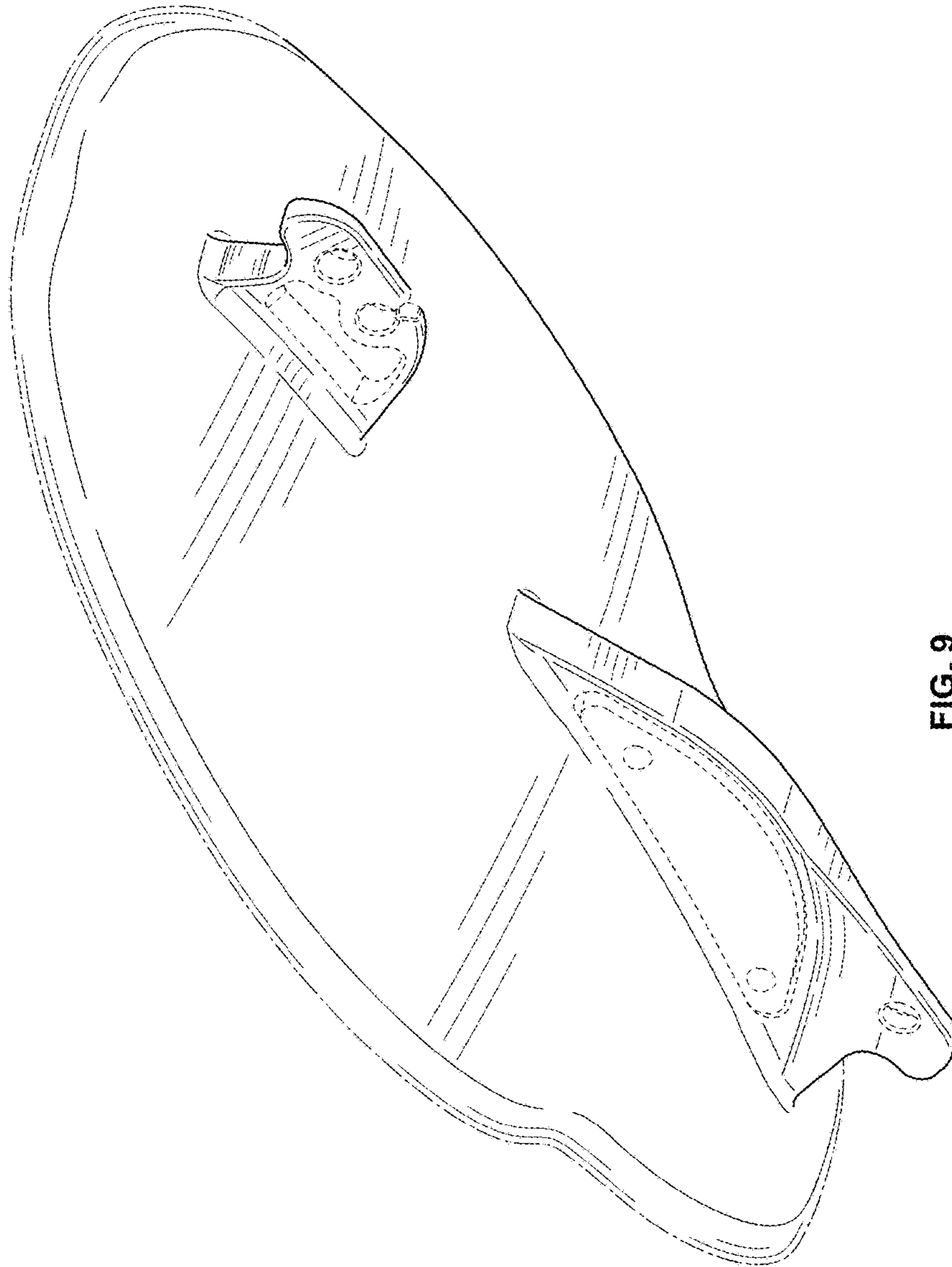

FIG. 9

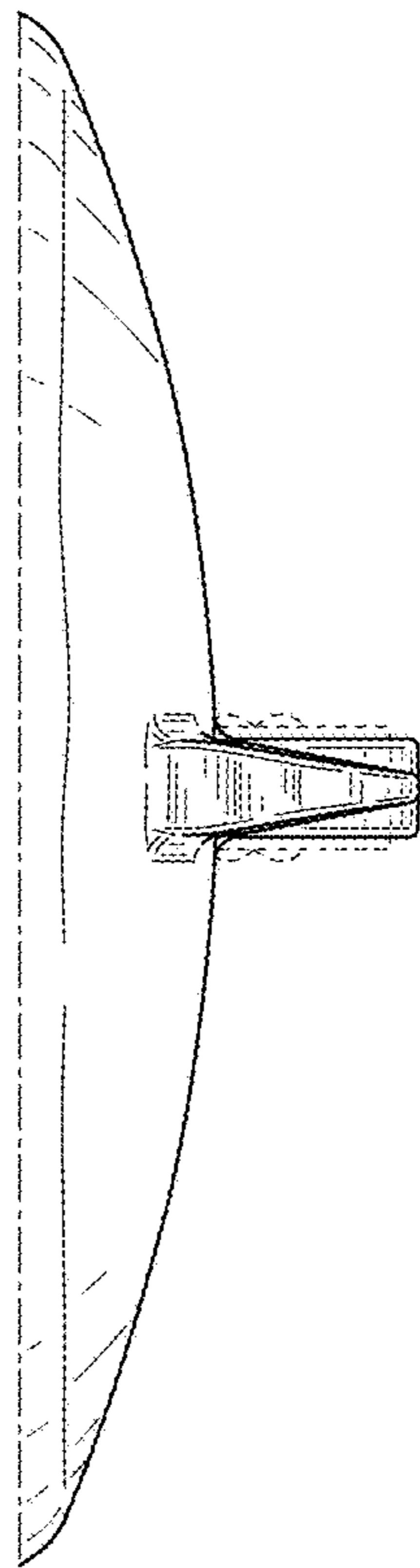

FIG. 10

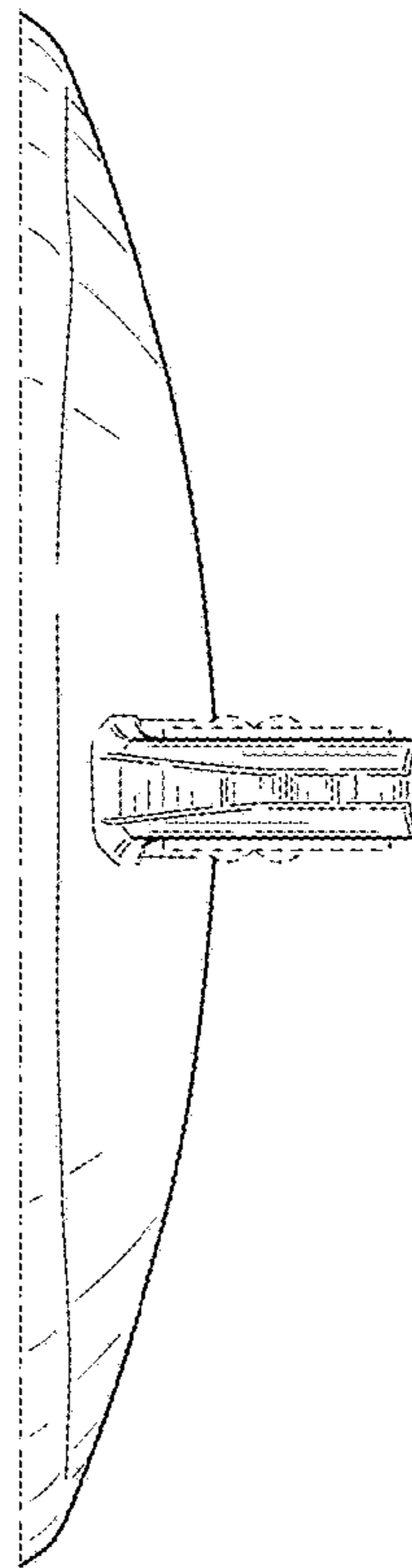

FIG. 11

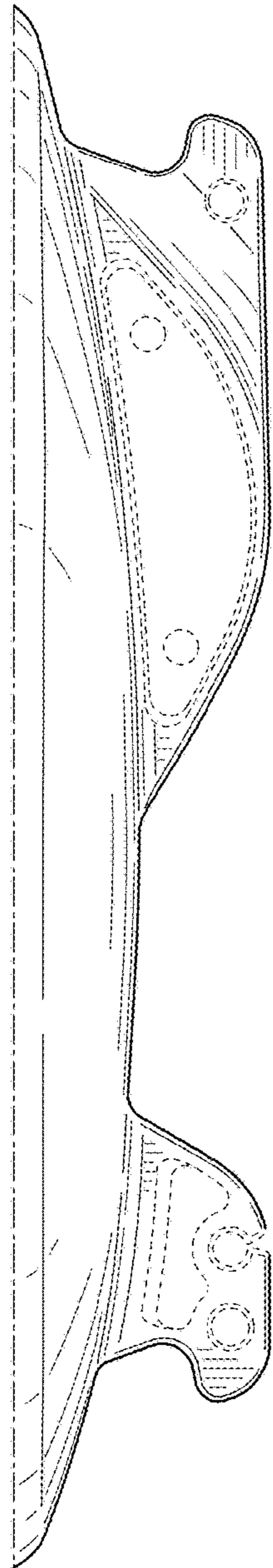

FIG. 12

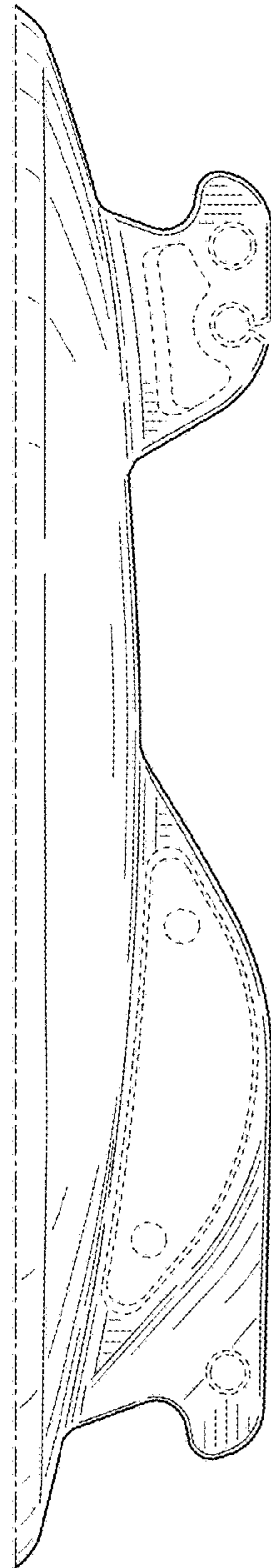

FIG. 13

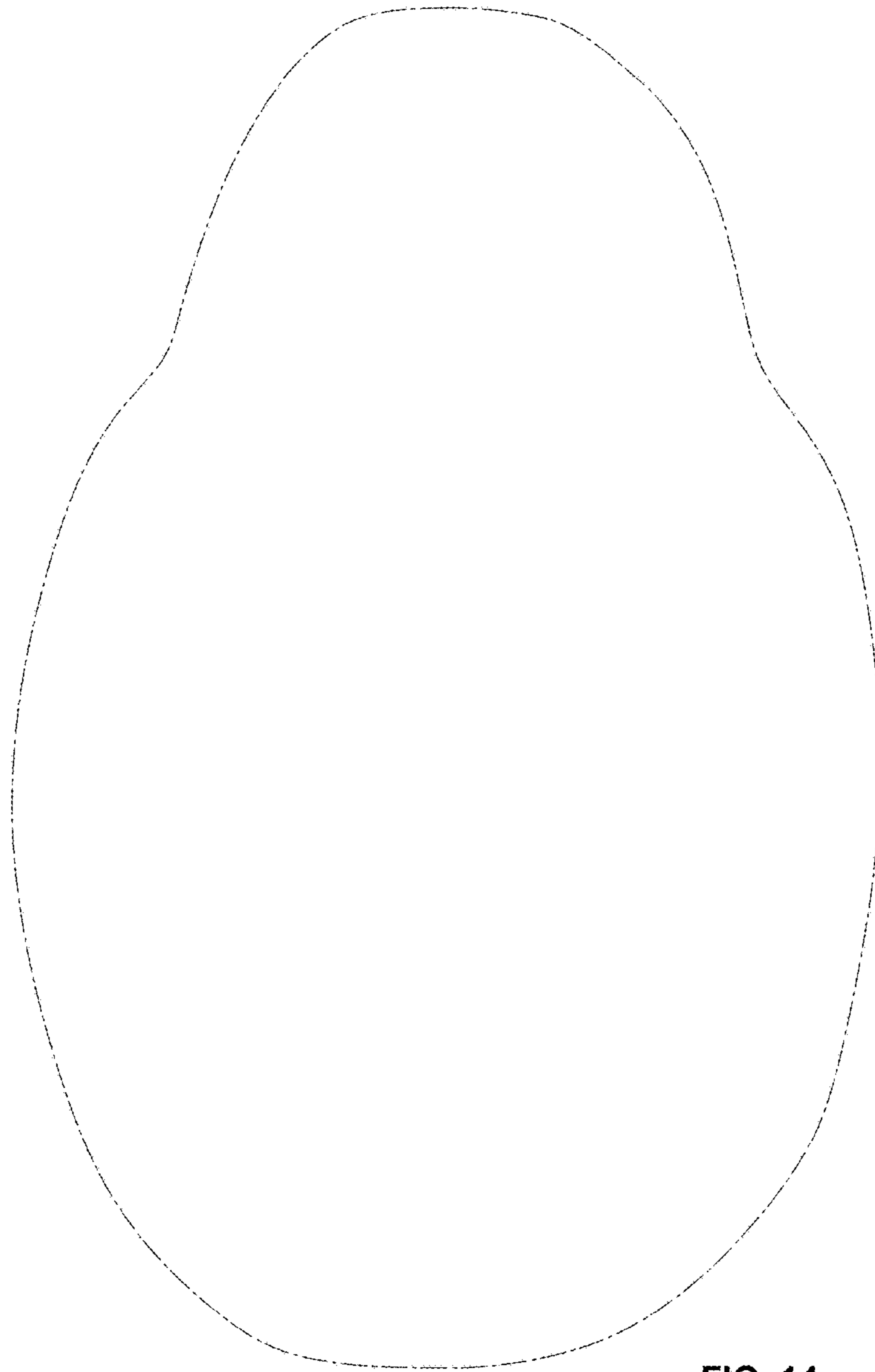

FIG. 14

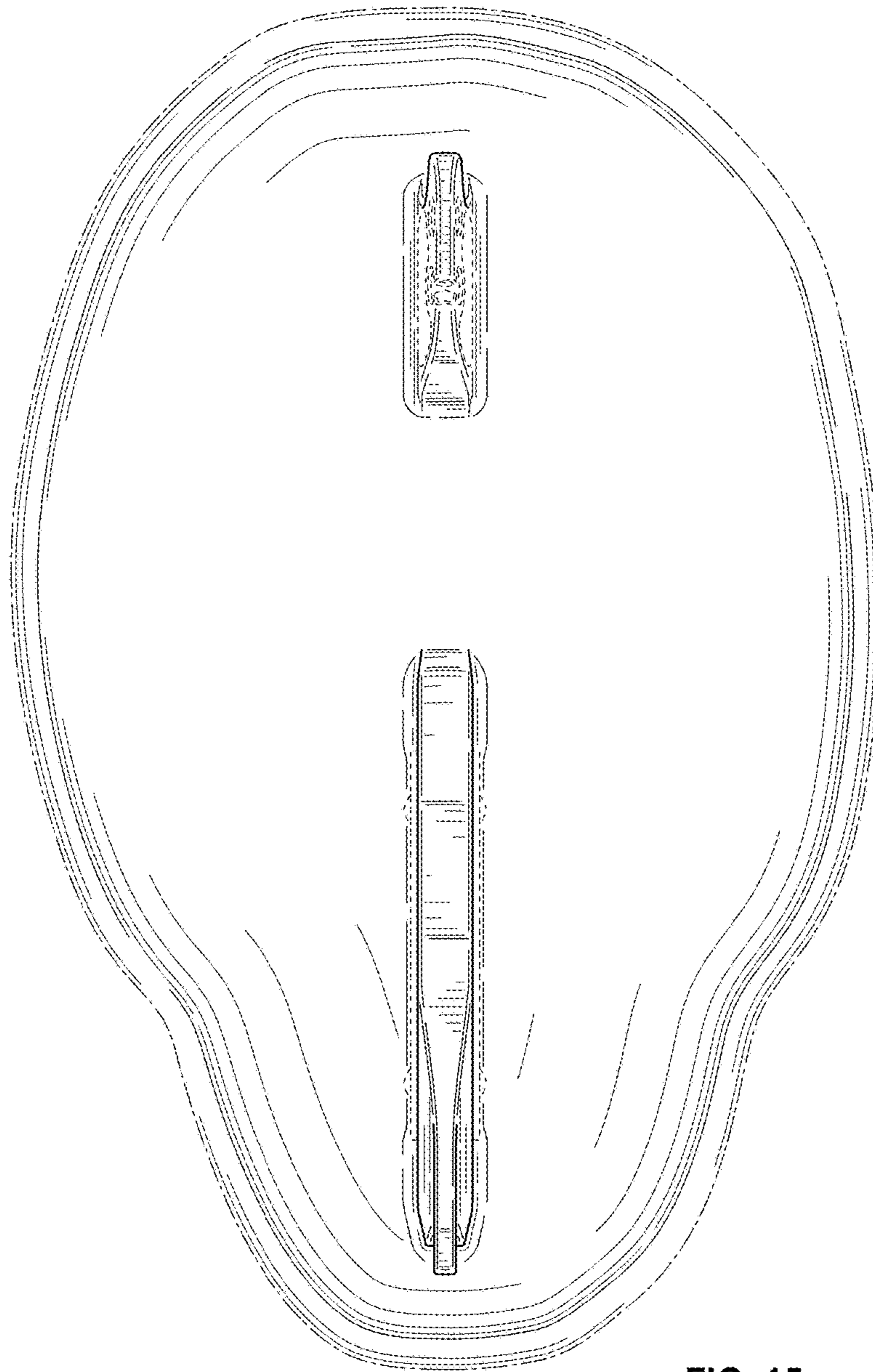

FIG. 15