



US00D865845S

(12) **United States Design Patent**  
**Sakai**

(10) **Patent No.:** **US D865,845 S**

(45) **Date of Patent:** **\*\* Nov. 5, 2019**

(54) **CAMERA**

(71) Applicant: **FUJIFILM Corporation**, Tokyo (JP)

(72) Inventor: **Masayuki Sakai**, Tokyo (JP)

(73) Assignee: **FUJIFILM Corporation**, Minato-Ku,  
Tokyo (JP)

(\*\*) Term: **15 Years**

(21) Appl. No.: **29/667,828**

(22) Filed: **Oct. 25, 2018**

(30) **Foreign Application Priority Data**

Apr. 27, 2018 (JP) ..... 2018-009534

(51) **LOC (12) Cl.** ..... **16-01**

(52) **U.S. Cl.**

USPC ..... **D16/218**

(58) **Field of Classification Search**

USPC ..... D16/200, 202–206, 208, 218, 219, 242;  
348/164, 347, 373–376; 396/535,  
396/539–541; 250/330, 332

CPC ..... G03B 15/03; G03B 17/02; G03B 17/04;  
G03B 17/56; G03B 19/04; H04N 5/2251;  
H04N 5/2252; H04N 5/2253; H04N  
5/2254; H04N 2101/00; H04N 5/33;  
H04N 5/332

See application file for complete search history.

(56) **References Cited**

**U.S. PATENT DOCUMENTS**

D692,939 S \* 11/2013 Huang ..... D16/218  
D697,122 S \* 1/2014 Ikegame ..... D16/218  
D709,543 S \* 7/2014 Isozaki ..... D16/218

D733,780 S \* 7/2015 Chen ..... D16/202  
D744,572 S \* 12/2015 Tabuchi ..... D16/218  
D754,234 S \* 4/2016 Lee ..... D16/218  
D754,769 S \* 4/2016 Patulski ..... D16/202  
D755,274 S \* 5/2016 Lee ..... D16/218  
D764,559 S \* 8/2016 Luo ..... D16/202  
D779,577 S \* 2/2017 Ikegame ..... D16/211  
D781,362 S \* 3/2017 Ikegame ..... D16/211  
D781,363 S \* 3/2017 Ikegame ..... D16/211  
D792,497 S \* 7/2017 Oliveira ..... D16/208

\* cited by examiner

*Primary Examiner* — Ramzi S Almatrahi

(74) *Attorney, Agent, or Firm* — Sughrue Mion, PLLC

(57) **CLAIM**

The ornamental design for a camera, as shown and described.

**DESCRIPTION**

FIG. 1 is a top, front and right side perspective view of a camera showing my new design;  
FIG. 2 is a top, rear and left side perspective view thereof;  
FIG. 3 is a front elevational view thereof;  
FIG. 4 is a rear elevational view thereof;  
FIG. 5 is a top plan view thereof;  
FIG. 6 is a bottom plan view thereof;  
FIG. 7 is a left side elevational view thereof;  
FIG. 8 is a right side elevational view thereof; and,  
FIG. 9 is a cross-sectional view thereof taken along line IX-IX of FIG. 3 and a portion defined by an arrow A and an arrow B of FIG. 7, in which an internal structure thereof is not shown.

The broken lines in FIGS. 5 and 9 depict portions of the camera in which the design is embodied that form no part of the claimed design.

**1 Claim, 8 Drawing Sheets**

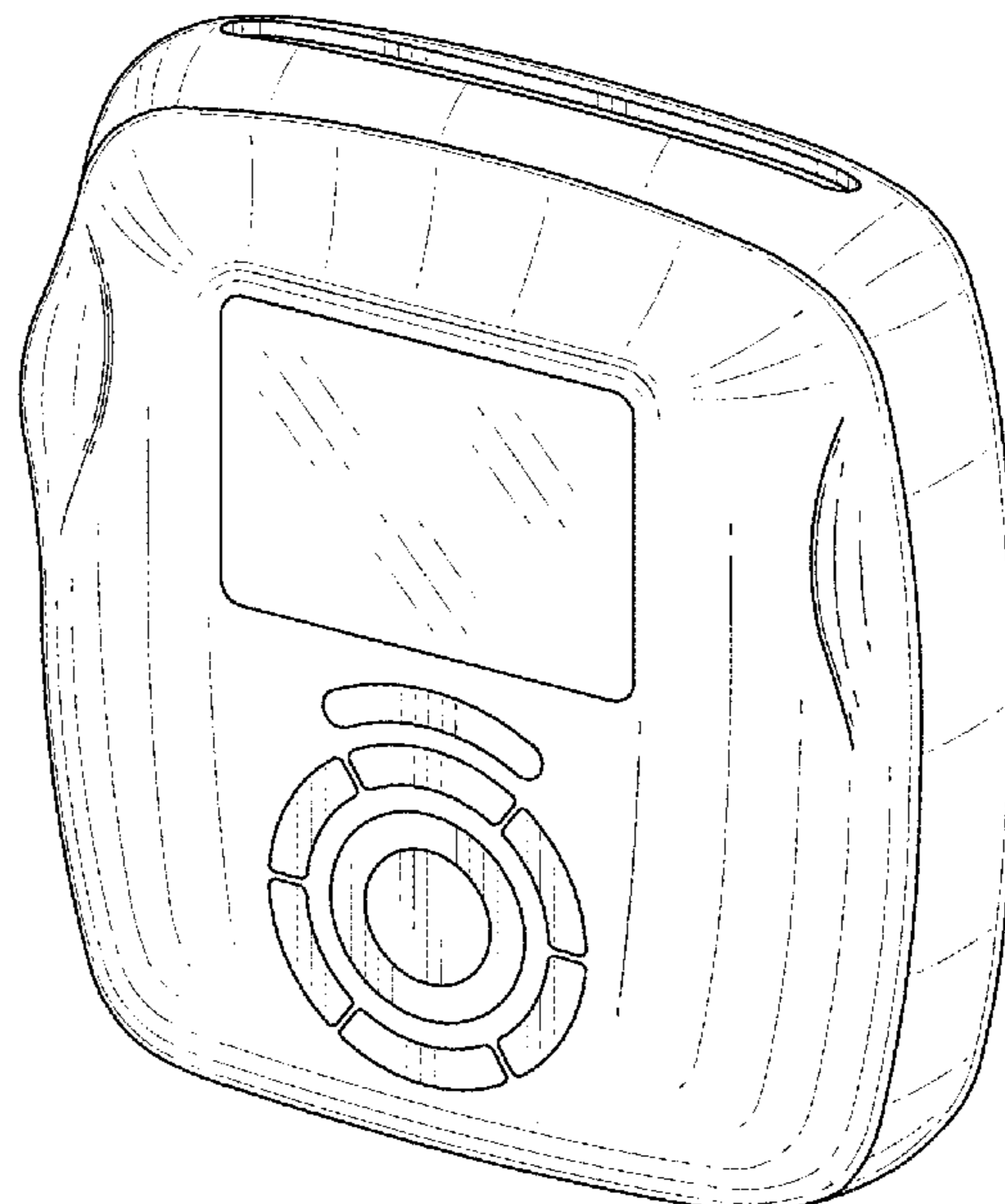
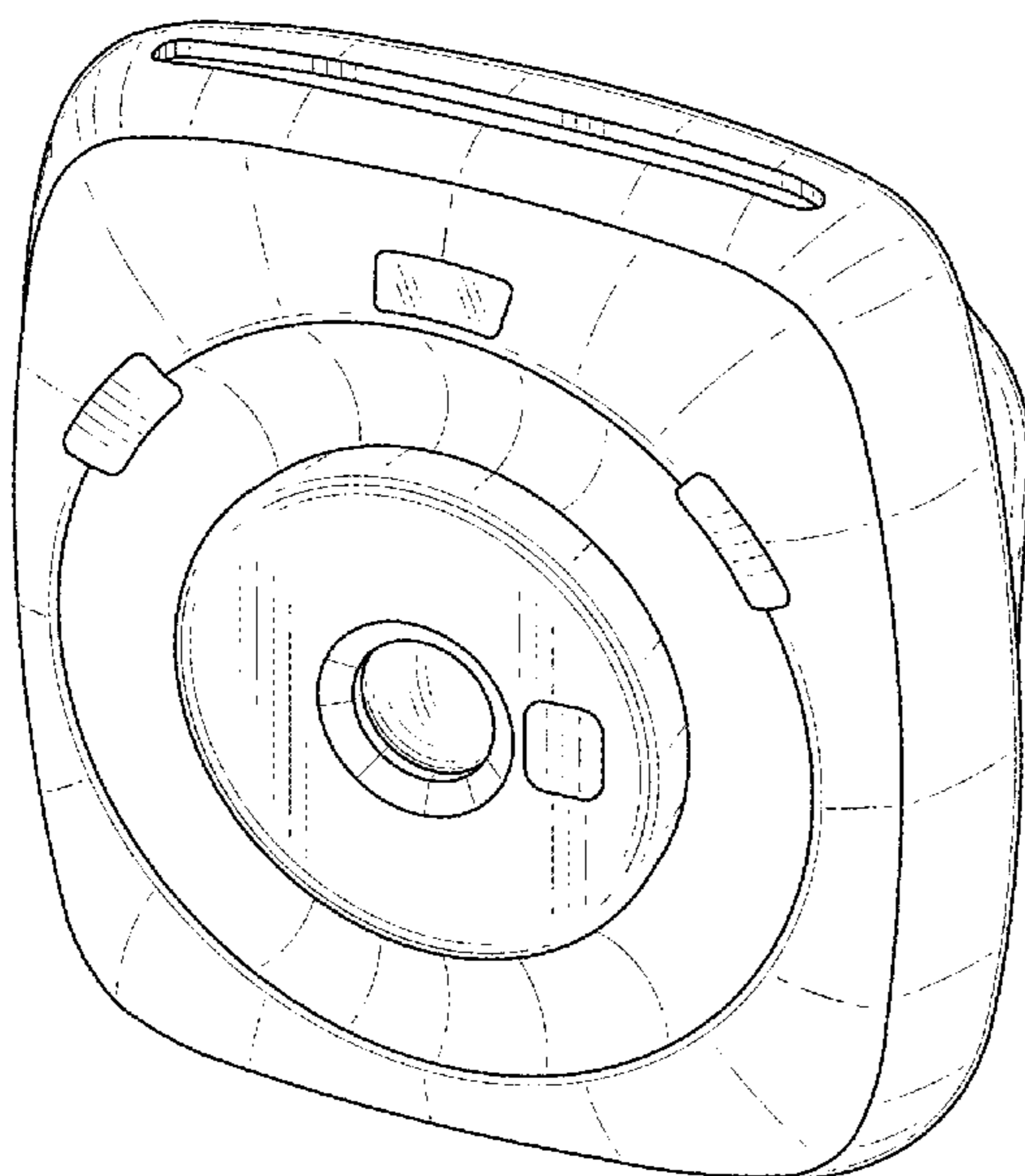

FIG. 1

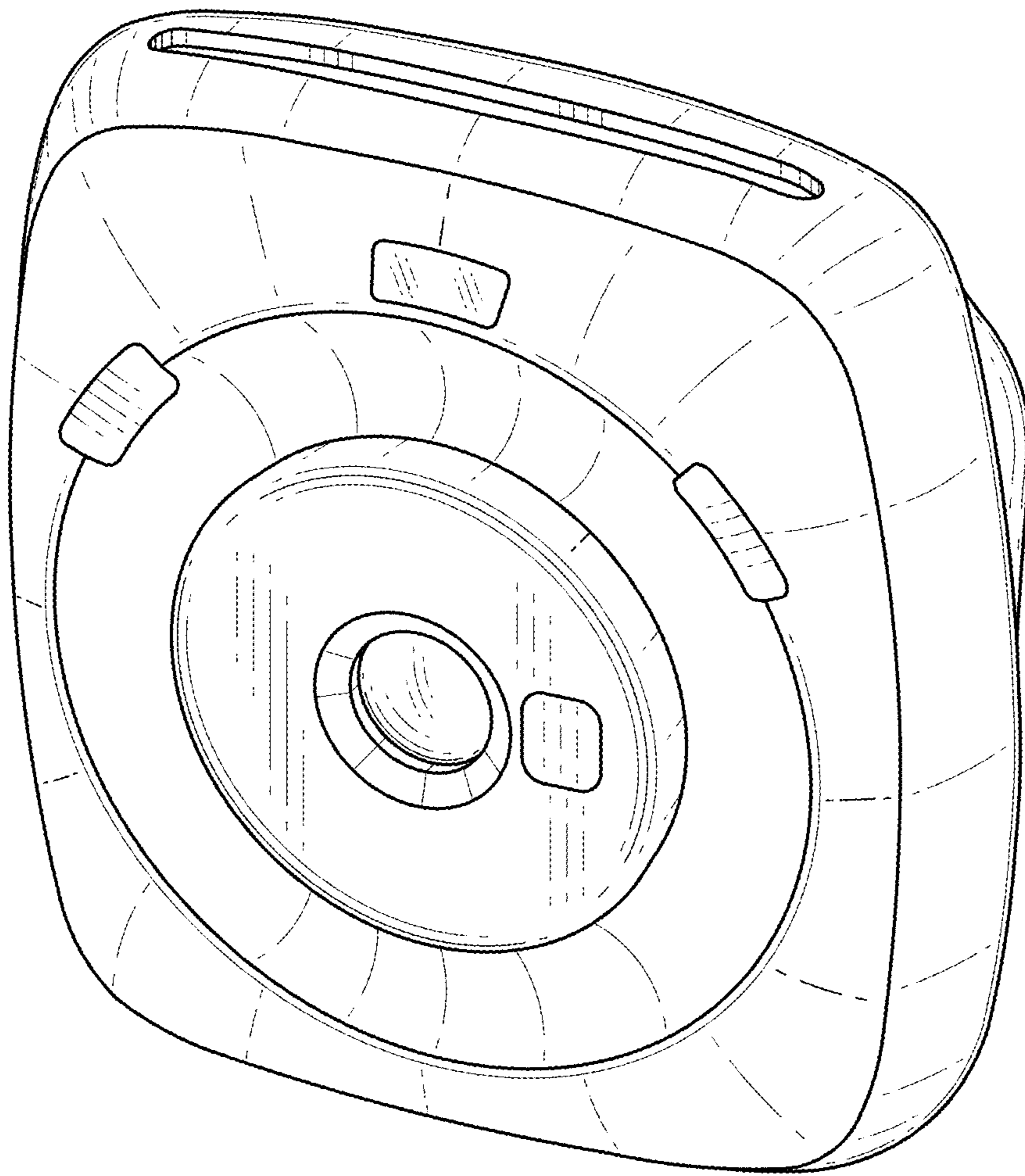

FIG.2

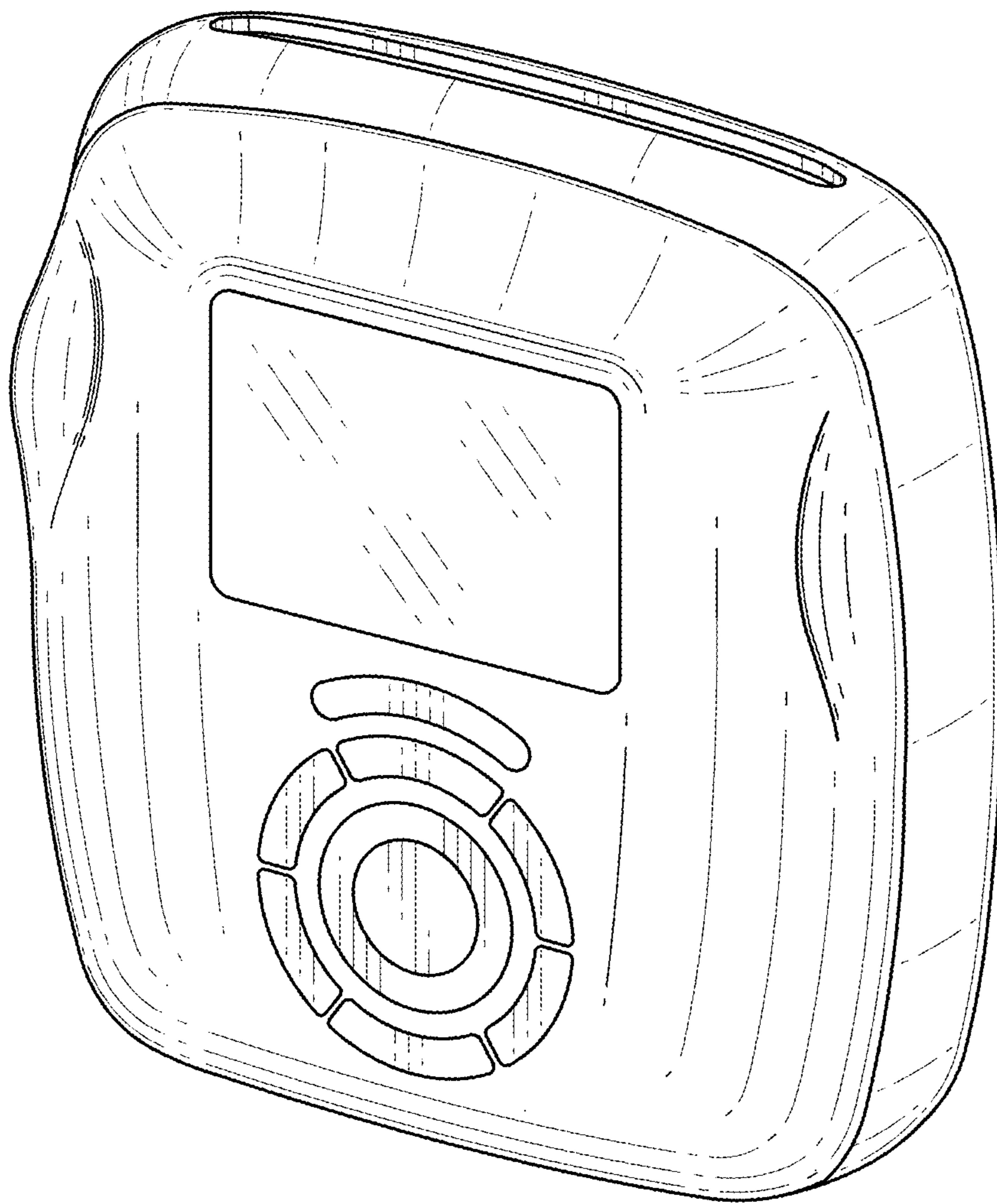

FIG.3

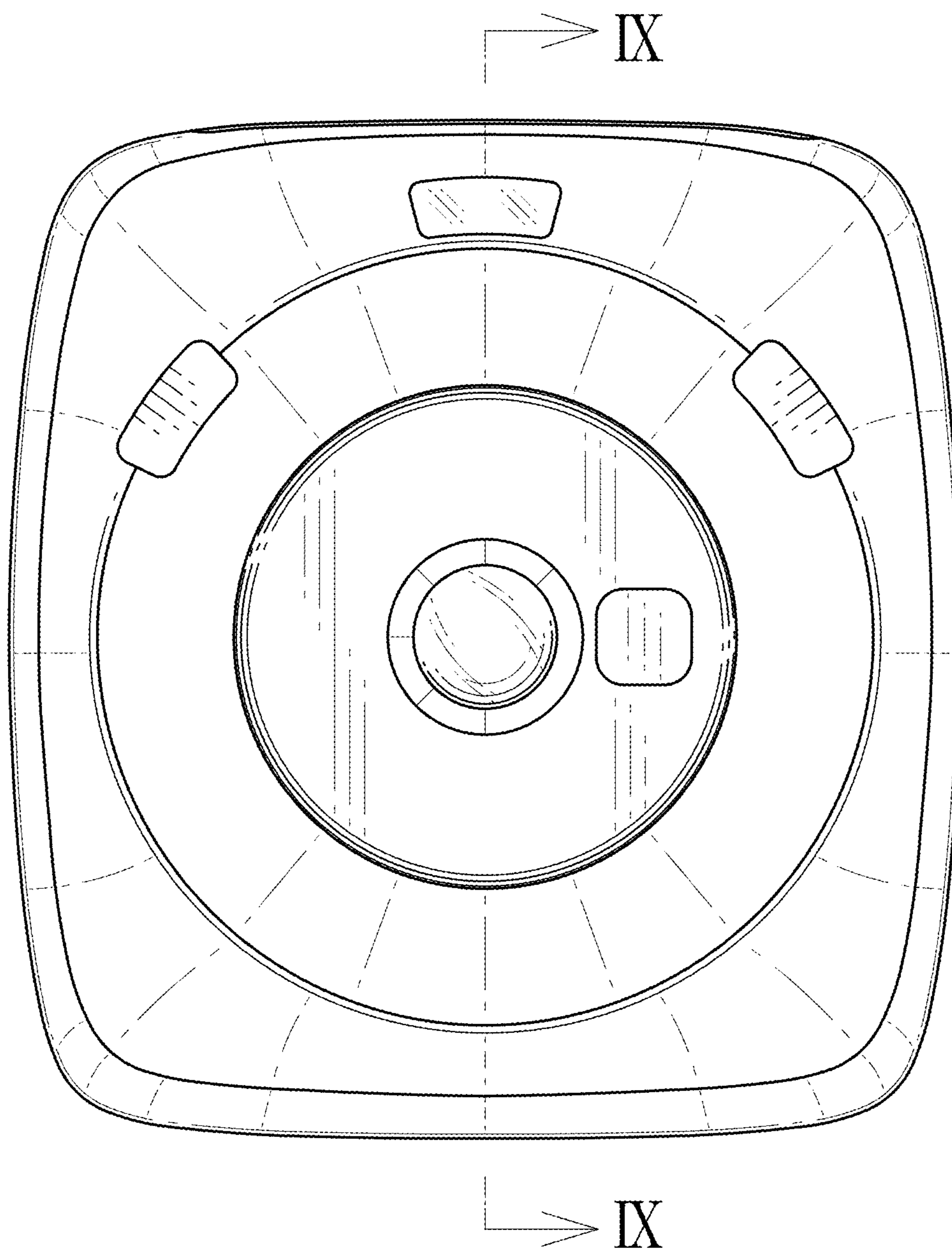

FIG. 4

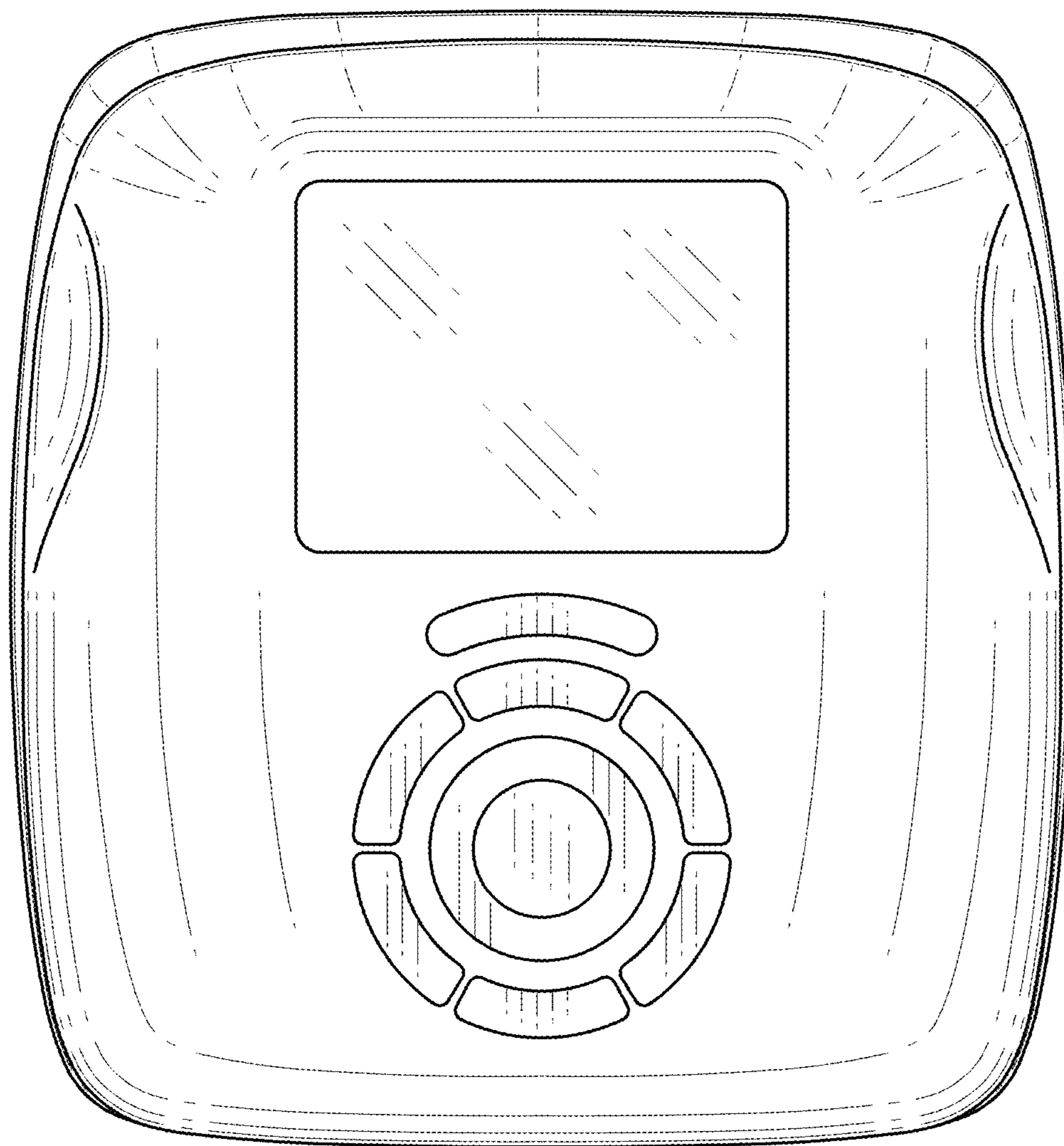

FIG.5

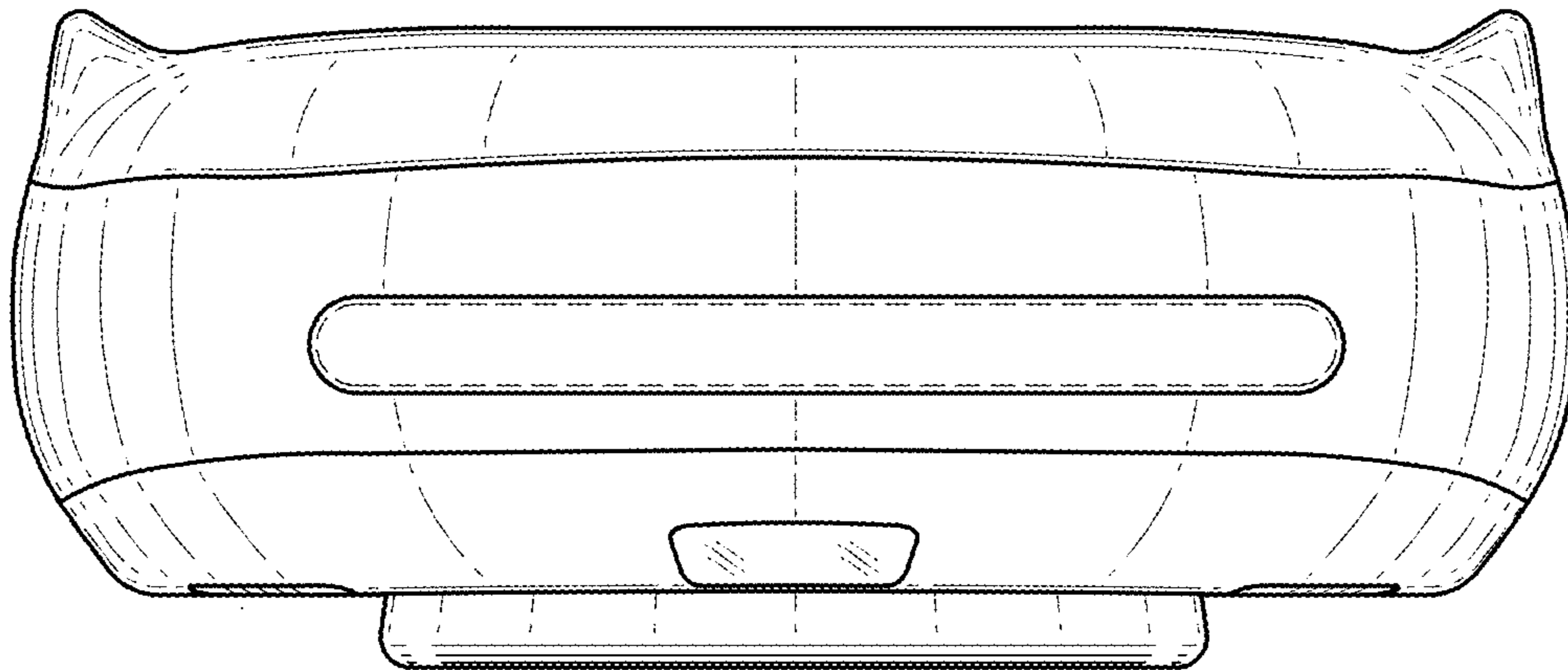

FIG.6

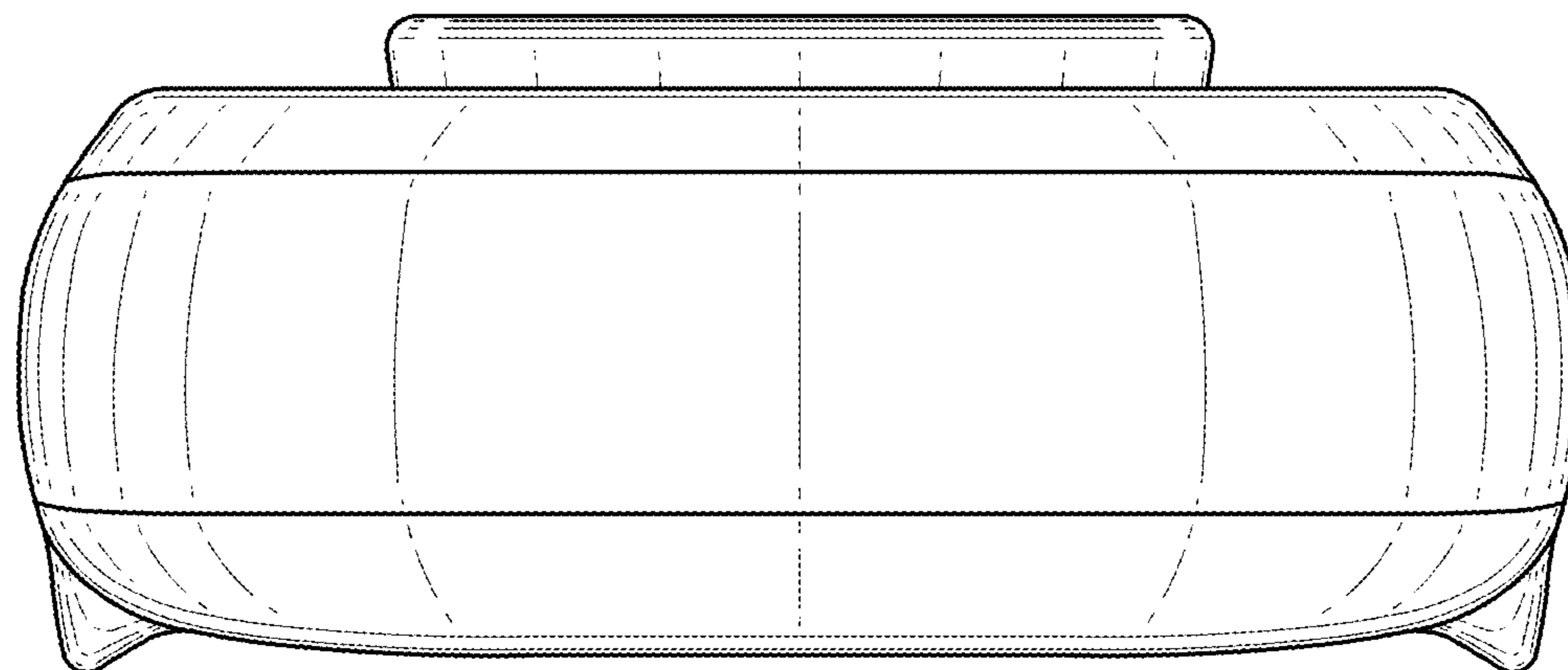

FIG.7

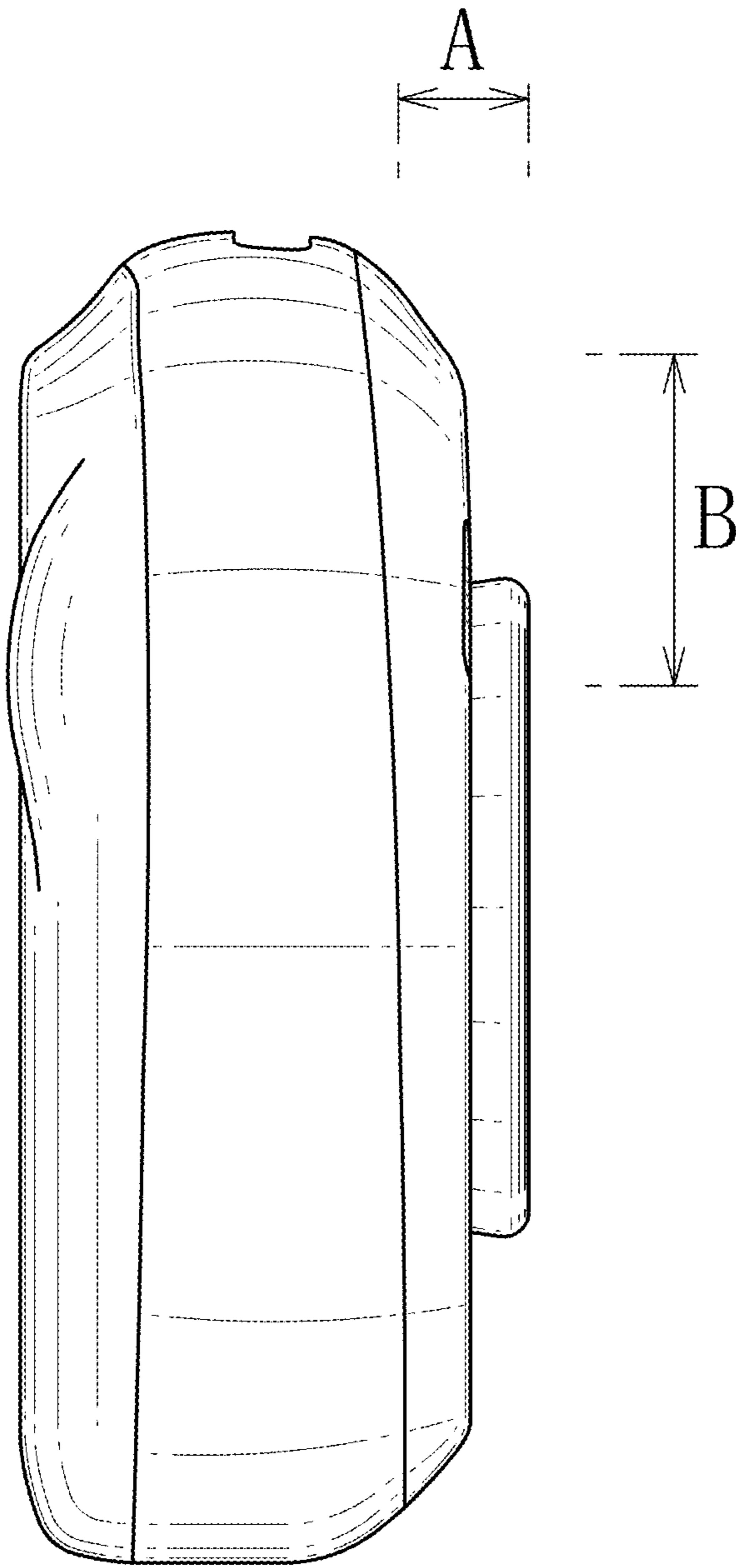

FIG. 8

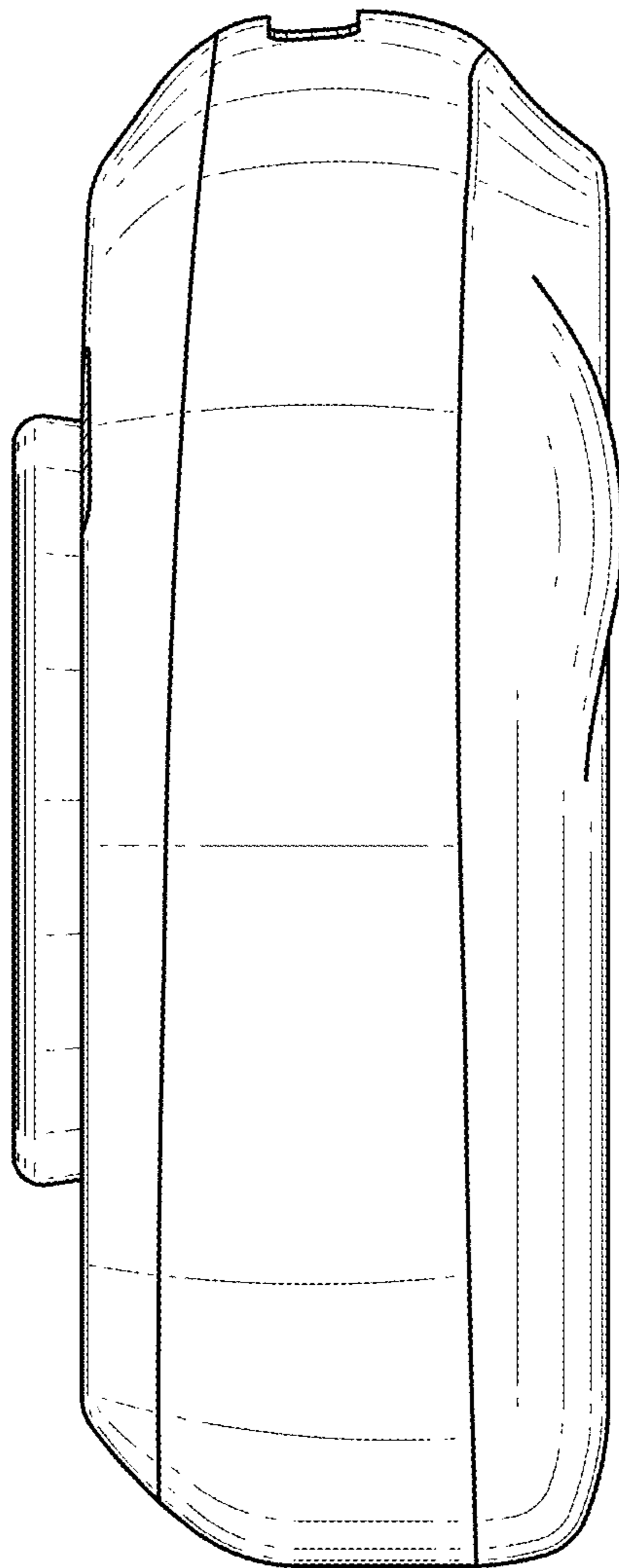



FIG. 9

