



US00D865756S

(12) **United States Design Patent** (10) **Patent No.:** **US D865,756 S**
Moon (45) **Date of Patent:** **** *Nov. 5, 2019**

(54) **LAPTOP COMPUTER**

(71) Applicant: **HEWLETT-PACKARD DEVELOPMENT COMPANY, L.P.**, Houston, TX (US)

(72) Inventor: **Philip Moon**, Houston, TX (US)

(73) Assignee: **Hewlett-Packard Development Company, L.P.**, Spring, TX (US)

(*) Notice: This patent is subject to a terminal disclaimer.

(**) Term: **15 Years**

(21) Appl. No.: **29/642,980**

(22) Filed: **Apr. 3, 2018**

(51) **LOC (12) Cl.** **14-02**

(52) **U.S. Cl.**
USPC **D14/327**

(58) **Field of Classification Search**
USPC D14/315–327, 331, 333–337, 439, D14/440–441, 444, 448, 450; D18/1–2, D18/7, 11, 12.2–12.3
CPC G06F 1/1601; G06F 1/1613; G06F 1/1615; G06F 1/1616; G06F 1/1633; G06F 1/1643; G06F 1/1652; G06F 1/1654; G06F 1/1669; G06F 1/1681; G06F 1/1688; G06F 1/203; H05K 5/0004; H05K 5/0017; H05K 5/0021; H05K 5/0043; H05K 5/0047; H05K 5/0052
See application file for complete search history.

(56) **References Cited**

U.S. PATENT DOCUMENTS

D461,470 S *	8/2002	Kawa	D14/318
D665,800 S *	8/2012	Hsu	D14/327
D683,344 S *	5/2013	Kao	D14/318
D706,259 S *	6/2014	Myung	D14/315
D720,741 S *	1/2015	Leonard	D14/315
D720,742 S *	1/2015	Leonard	D14/315

D734,323 S *	7/2015	Takizawa	D14/316
D746,809 S *	1/2016	Takada	D14/327
D766,233 S *	9/2016	Lam	D14/315
9,489,054 B1 *	11/2016	Sumsion	G06F 3/0208

(Continued)

OTHER PUBLICATIONS

Vogel, Sandra, Asus B9440UA review, posted at ZDNet, posting date May 19, 2017. Site visited Jun. 5, 2019. URL: <https://www.zdnet.com/product/asuspro-b9440ua> (Year: 2017).*

(Continued)

Primary Examiner — Kevin K Rudzinski
Assistant Examiner — Kathleen L Jones

(57) **CLAIM**

I claim the ornamental design for a laptop computer, as shown and described.

DESCRIPTION

FIG. 1 is a front, top, right perspective view of the claimed design in a first configuration;
FIG. 2 is a top plan view thereof;
FIG. 3 is a bottom plan view thereof;
FIG. 4 a right side elevation view thereof;
FIG. 5 is a left side elevation view thereof;
FIG. 6 is a rear elevation view thereof; and
FIG. 7 is a front elevation view thereof;
FIG. 8 is a front, top, left perspective view of the claimed design in a second configuration;
FIG. 9 is a top plan view thereof;
FIG. 10 is a bottom plan view thereof;
FIG. 11 a right side elevation view thereof;
FIG. 12 is a left side elevation view thereof;
FIG. 13 is a rear elevation view thereof; and
FIG. 14 is a front elevation view thereof.

The broken lines showing portions of the laptop computer are included for the purpose of illustrating portions of the article and form no part of the claimed design.

1 Claim, 12 Drawing Sheets

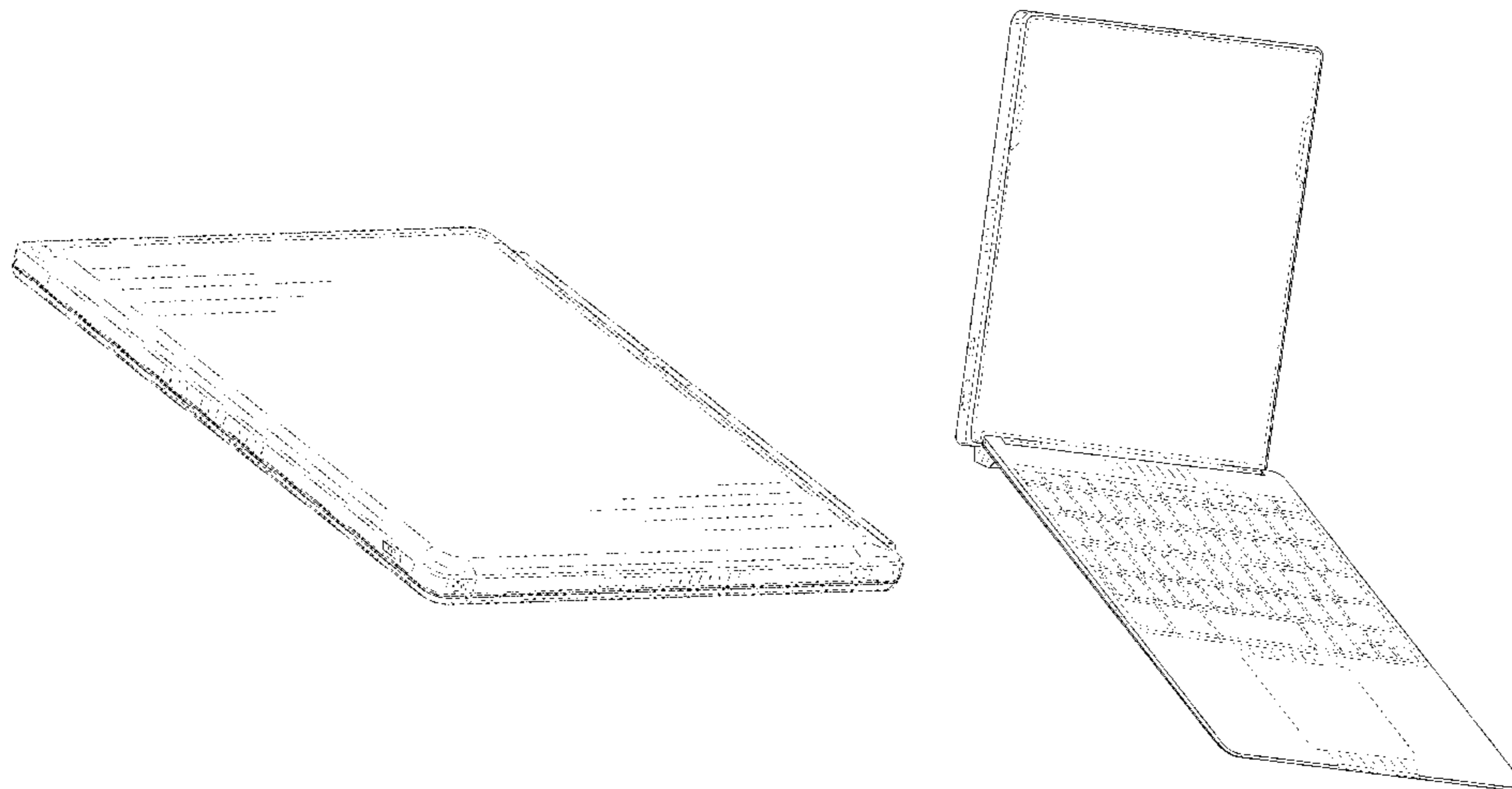

(56)

References Cited

U.S. PATENT DOCUMENTS

D789,353 S * 6/2017 Sakatsume D14/315
 D789,356 S * 6/2017 Cebe D14/315
 D802,583 S * 11/2017 Oakley D14/315
 D804,466 S * 12/2017 Okuley D14/315
 D807,342 S * 1/2018 Chang D14/315
 D807,345 S * 1/2018 Senatori D14/316
 D813,860 S * 3/2018 Doczy D14/315
 D821,387 S * 6/2018 Wang D14/315
 D829,707 S * 10/2018 Tin D14/315
 D837,202 S * 1/2019 Lee D14/315
 D838,714 S * 1/2019 Lin D14/318
 10,203,729 B1 * 2/2019 Chen G06F 1/1654
 10,254,794 B1 * 4/2019 Wu G06F 1/1641
 10,303,216 B1 * 5/2019 Powell G06F 1/1654
 2011/0267757 A1 * 11/2011 Probst G06F 1/1616
 361/679.09
 2012/0106078 A1 * 5/2012 Probst G06F 1/1616
 361/679.56
 2013/0170126 A1 * 7/2013 Lee G06F 1/1654
 361/679.17
 2013/0322011 A1 * 12/2013 Yeh G06F 1/181
 361/679.44
 2014/0048393 A1 * 2/2014 Wu H01H 21/18
 200/61.39
 2015/0043155 A1 * 2/2015 Liang G06F 1/1632
 361/679.43

2016/0054761 A1 * 2/2016 Wolff E05D 7/10
 361/679.09
 2016/0062484 A1 * 3/2016 Sugiura G06F 3/0202
 345/156
 2017/0192478 A1 * 7/2017 Mercer G06F 1/28
 2017/0269638 A1 * 9/2017 Chen G06F 1/1616
 2019/0129546 A1 * 5/2019 Lee G06F 3/0412

OTHER PUBLICATIONS

Vogel, Sandra, Dell Latitude 11 5179 Review, posted at ZDNet, posting date Sep. 20, 2016. Site visited Jun. 5, 2019. URL: <https://www.zdnet.com/product/dell-latitude-11-5000> (Year: 2016).*

Molck, Sascha, HP Split x2 13-m210eg Convertible Review, posted at NotebookCheck, posting date Sep. 13, 2014. Site visited Jun. 5, 2019. URL: <https://www.notebookcheck.net/hp-split-x2-13-m210eg-convertible-review.125829.0.html> (Year: 2014).*

Rahman, Mishaal, HP Chromebook X2 is the first Detachable Chromebook with Linux app support, posted at XDA Developers, posting date Jun. 14, 2018. Site visited May 21, 2019. URL: <https://www.xda-developers.com/hp-chromebook-x2-linux-app-support> (Year: 2018).*

Martindale, Jon, HP readies new Pavilion x2 and Envy laptops for Windows 10, posted at Digital Trends, posting date Jun. 18, 2015. Site visited Jun. 5, 2019. URL: <https://www.digitaltrends.com/computing/hp-pavilion-x2-envy-laptop> (Year: 2015).*

* cited by examiner

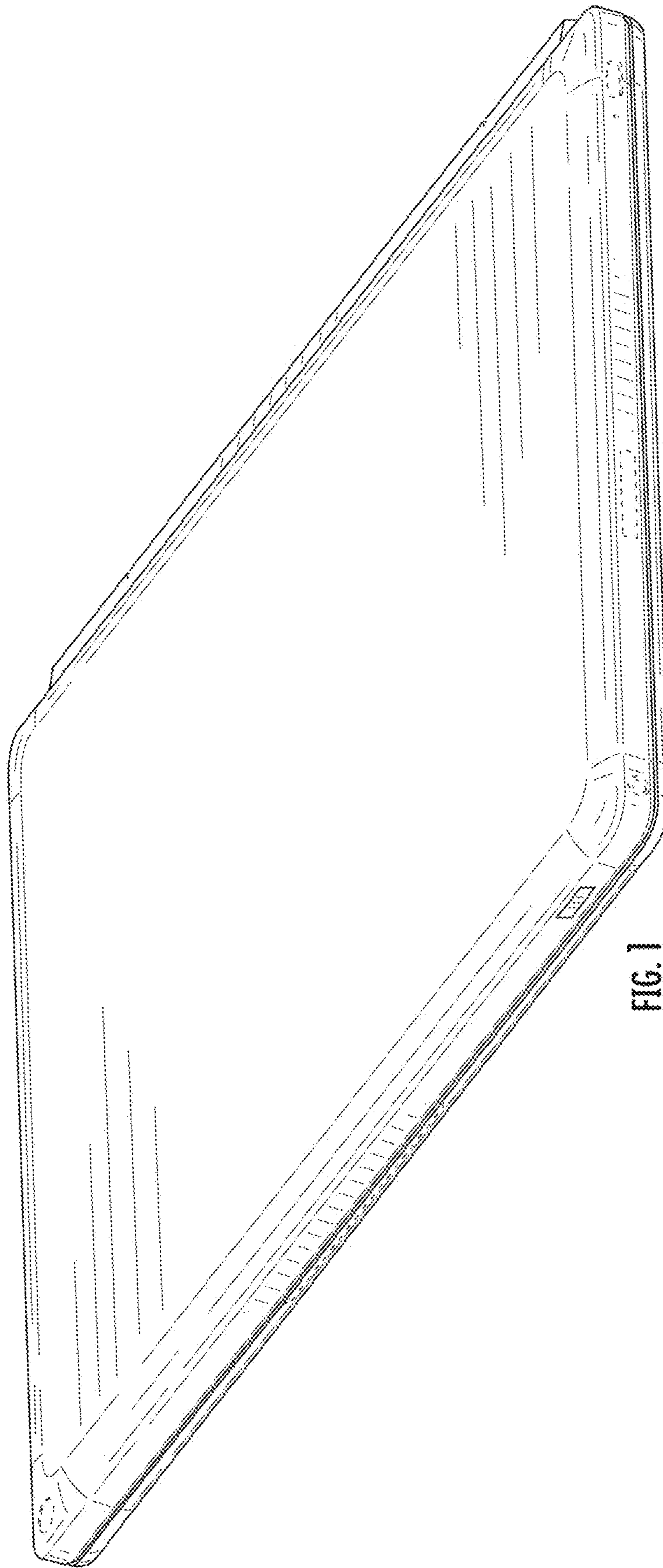

FIG. 1

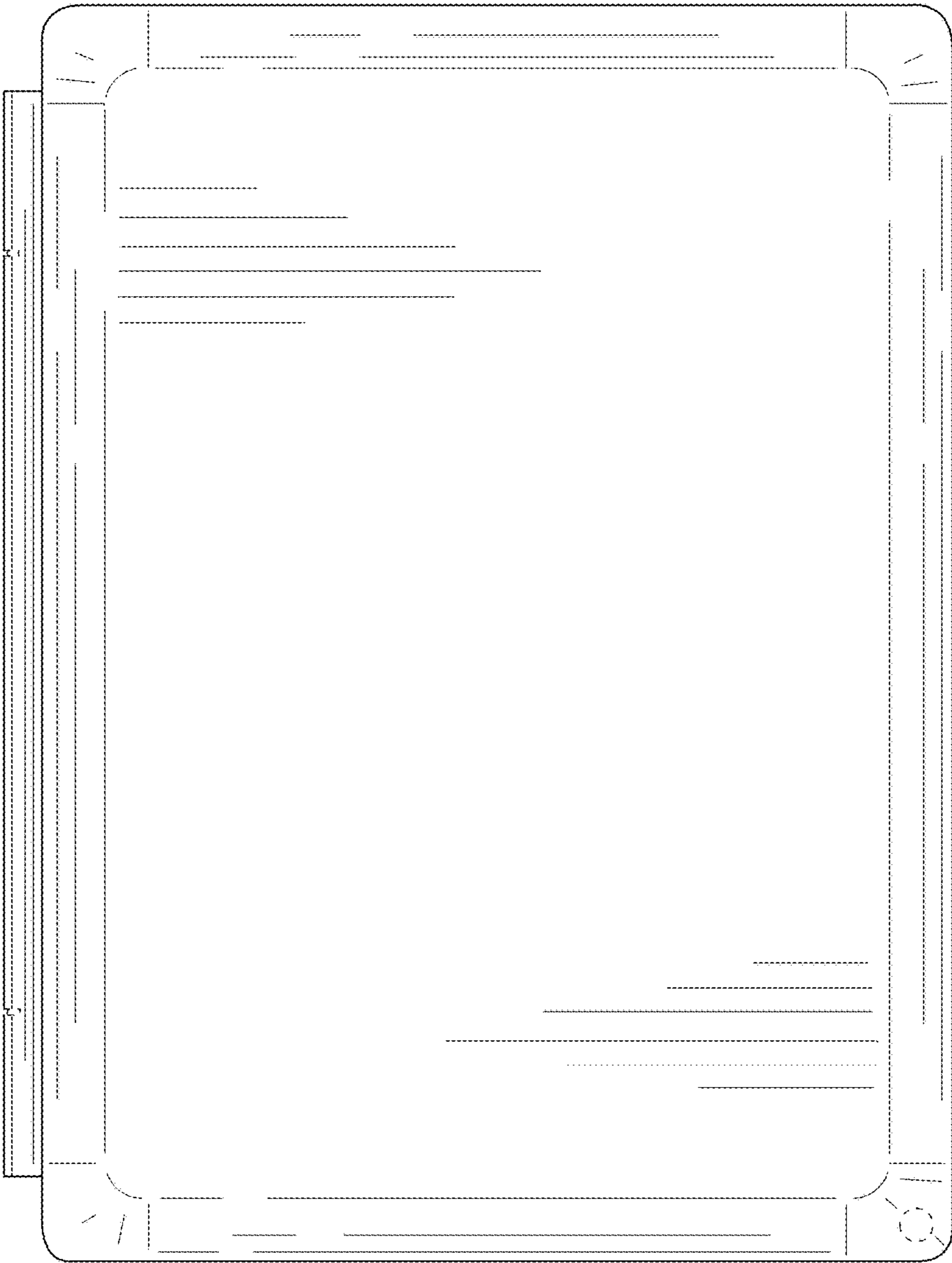

FIG. 2

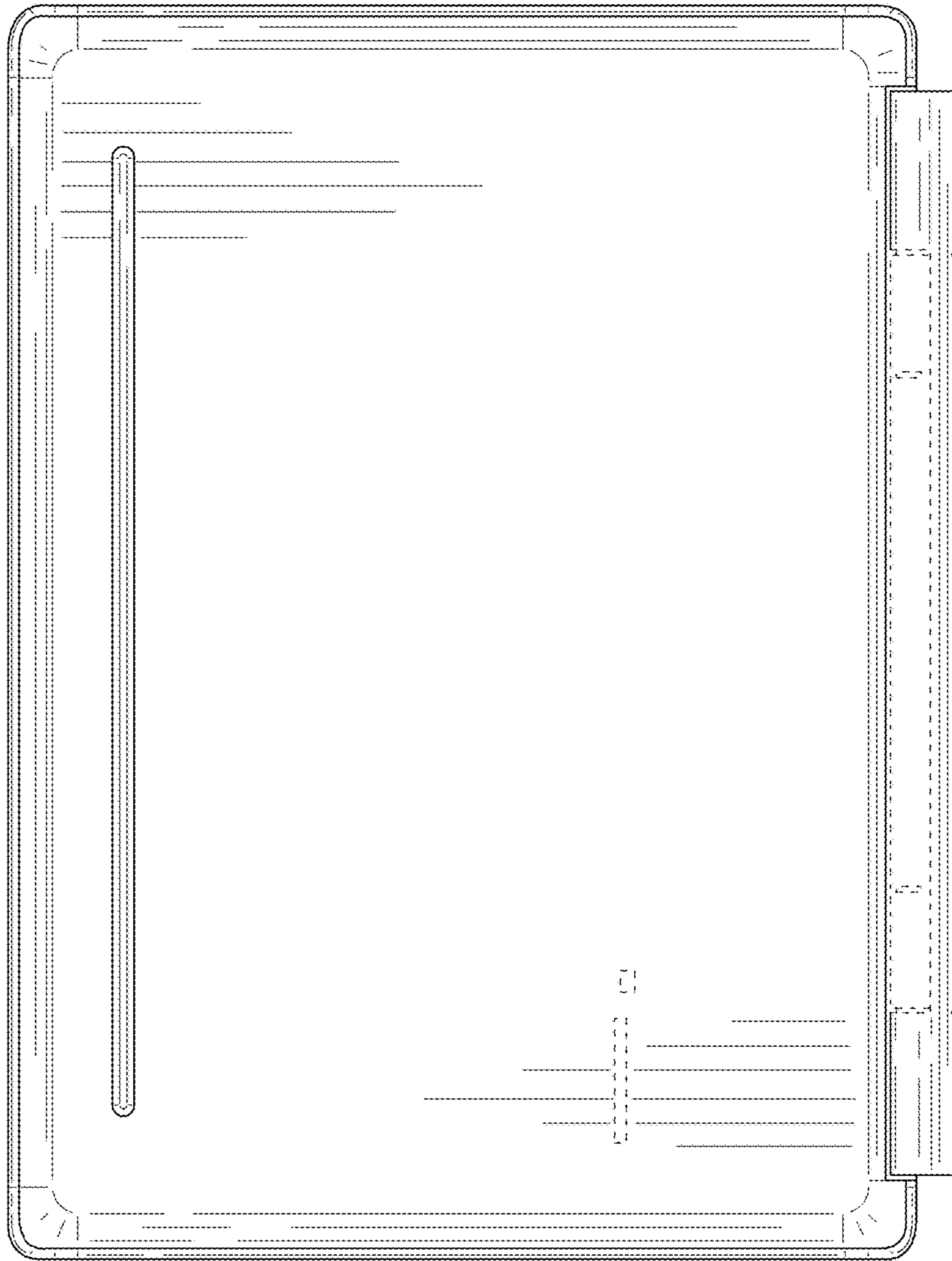

FIG. 3

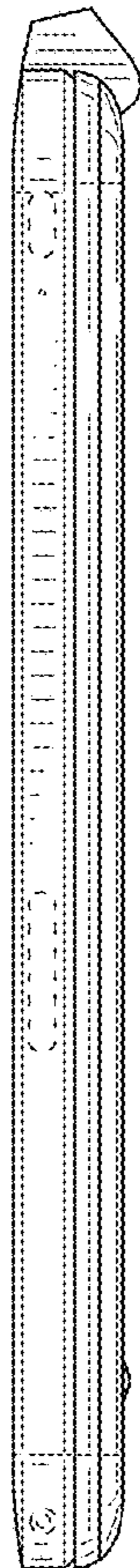

FIG. 4

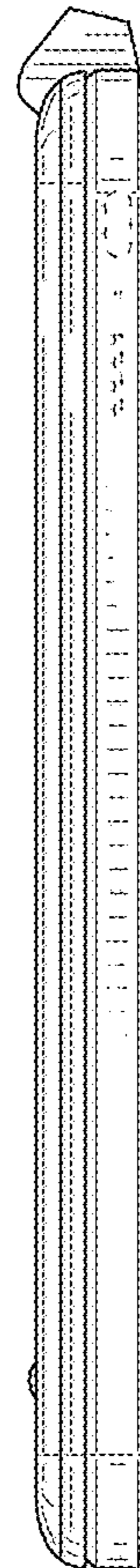

FIG. 5

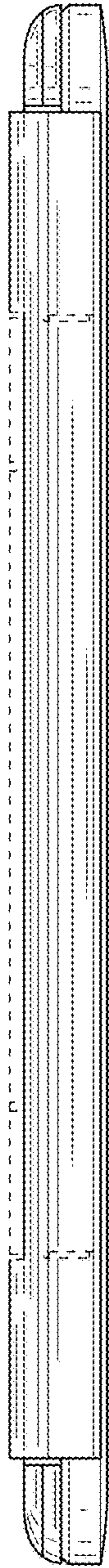

FIG. 6

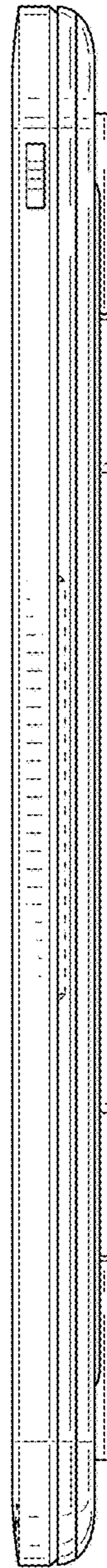

FIG. 7

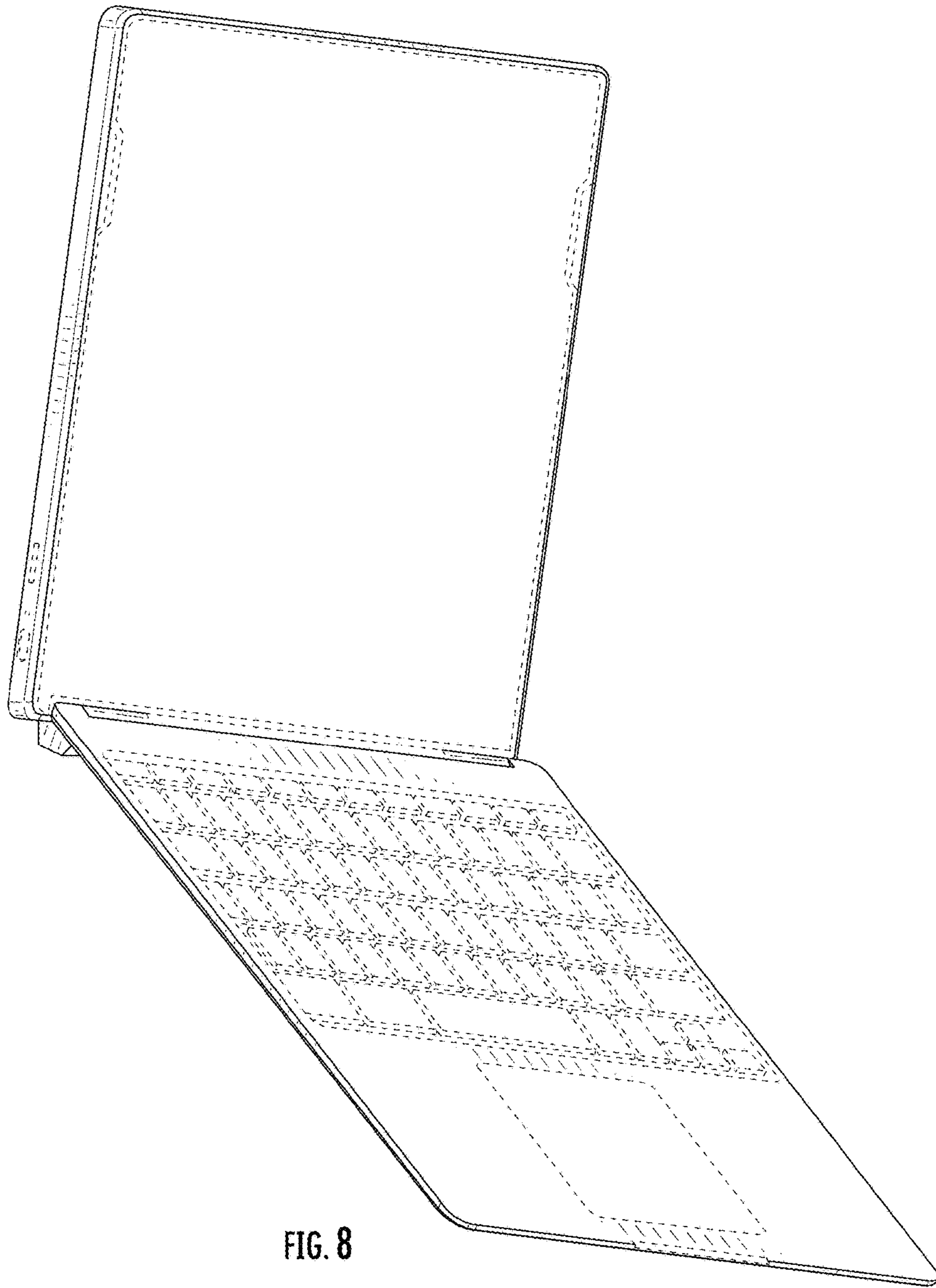

FIG. 8

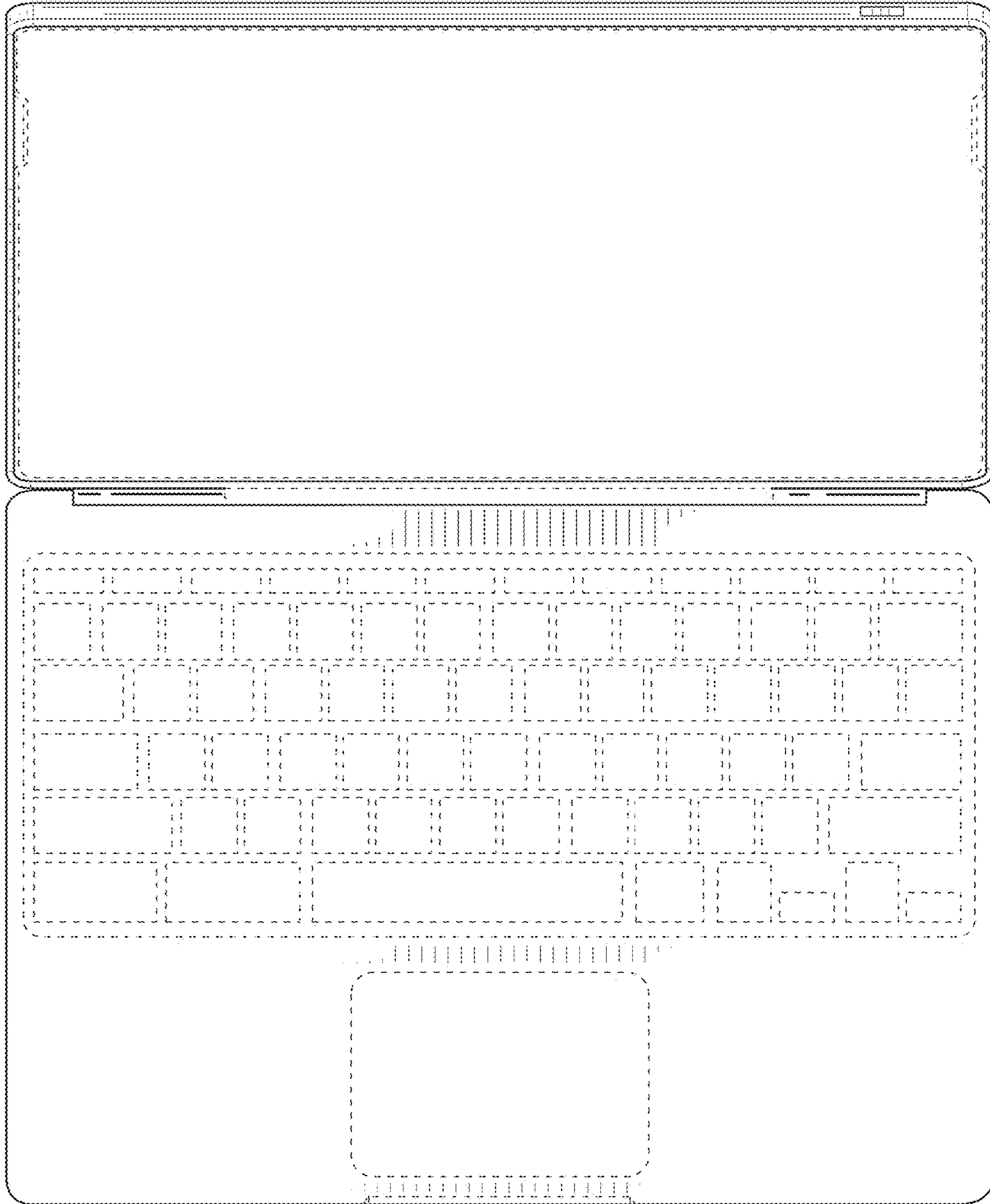

FIG9

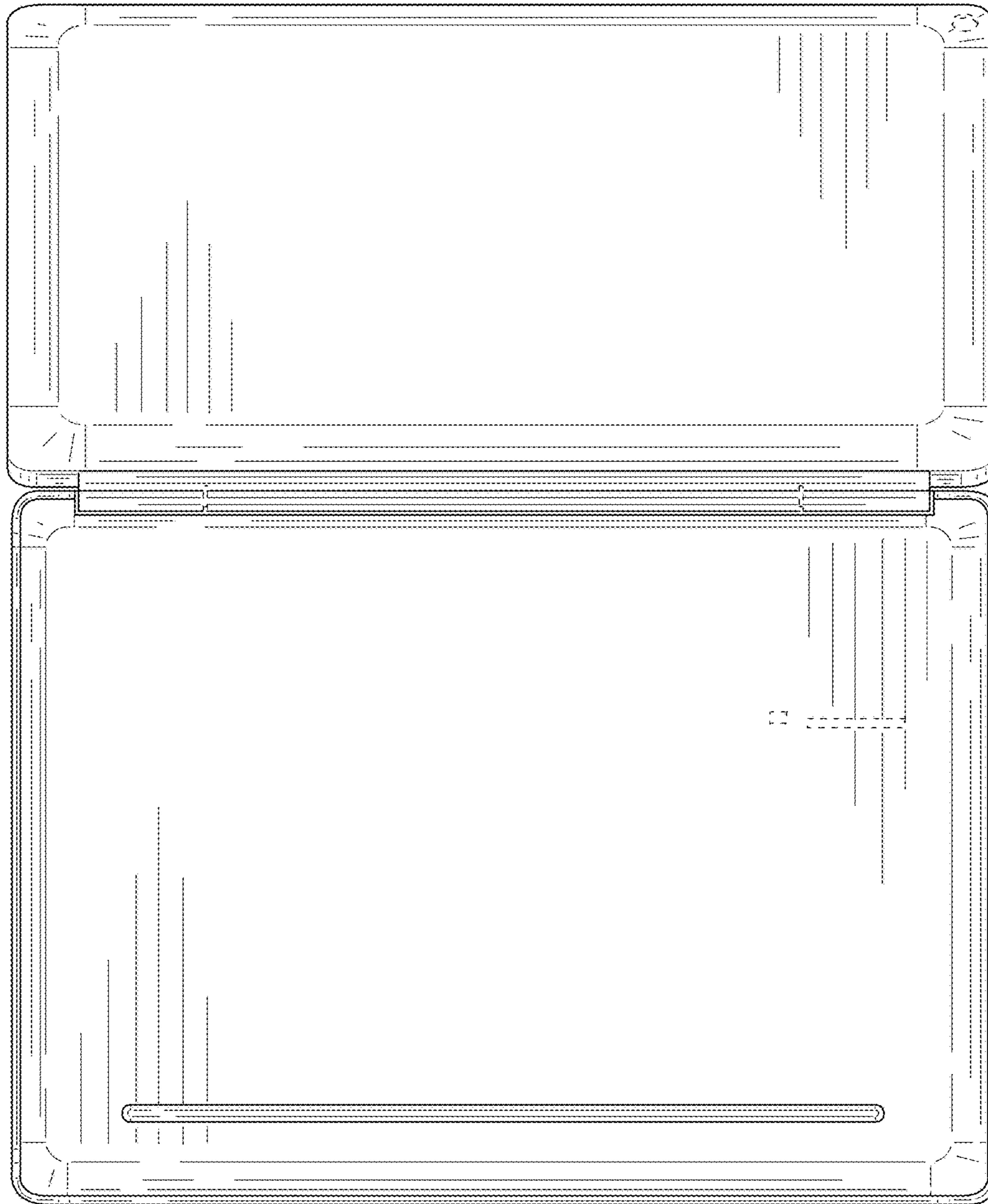

FIG. 10

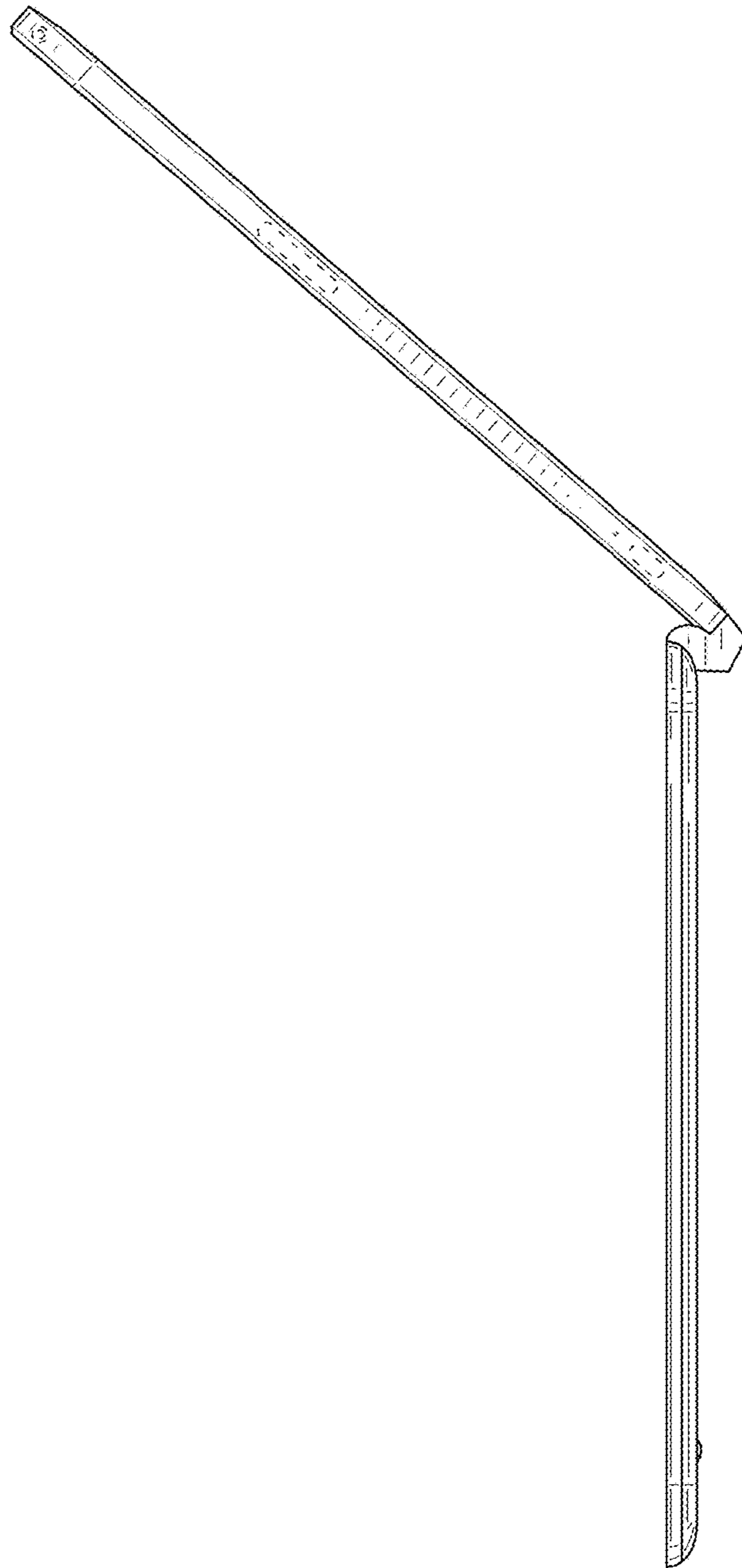

FIG. 11

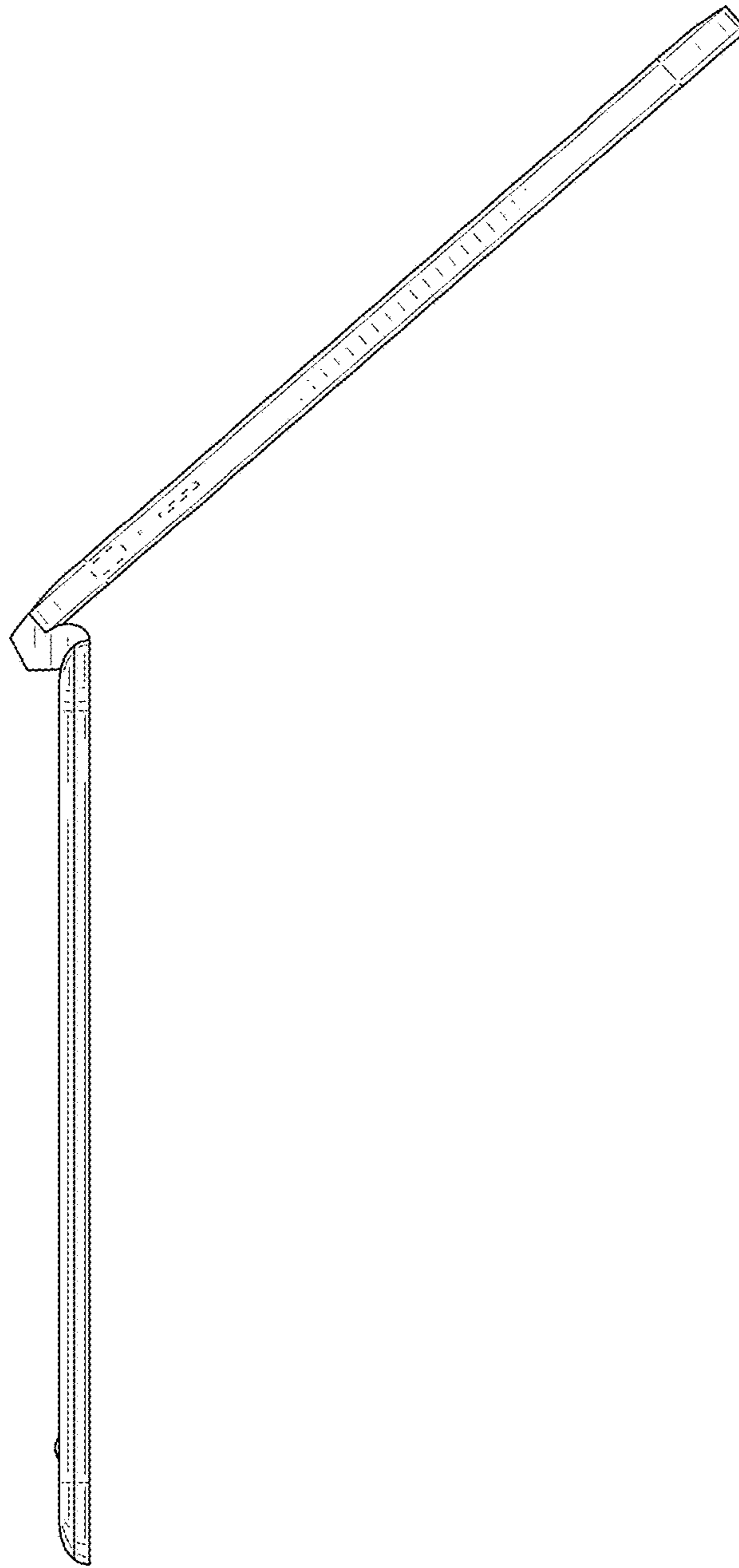

FIG. 12

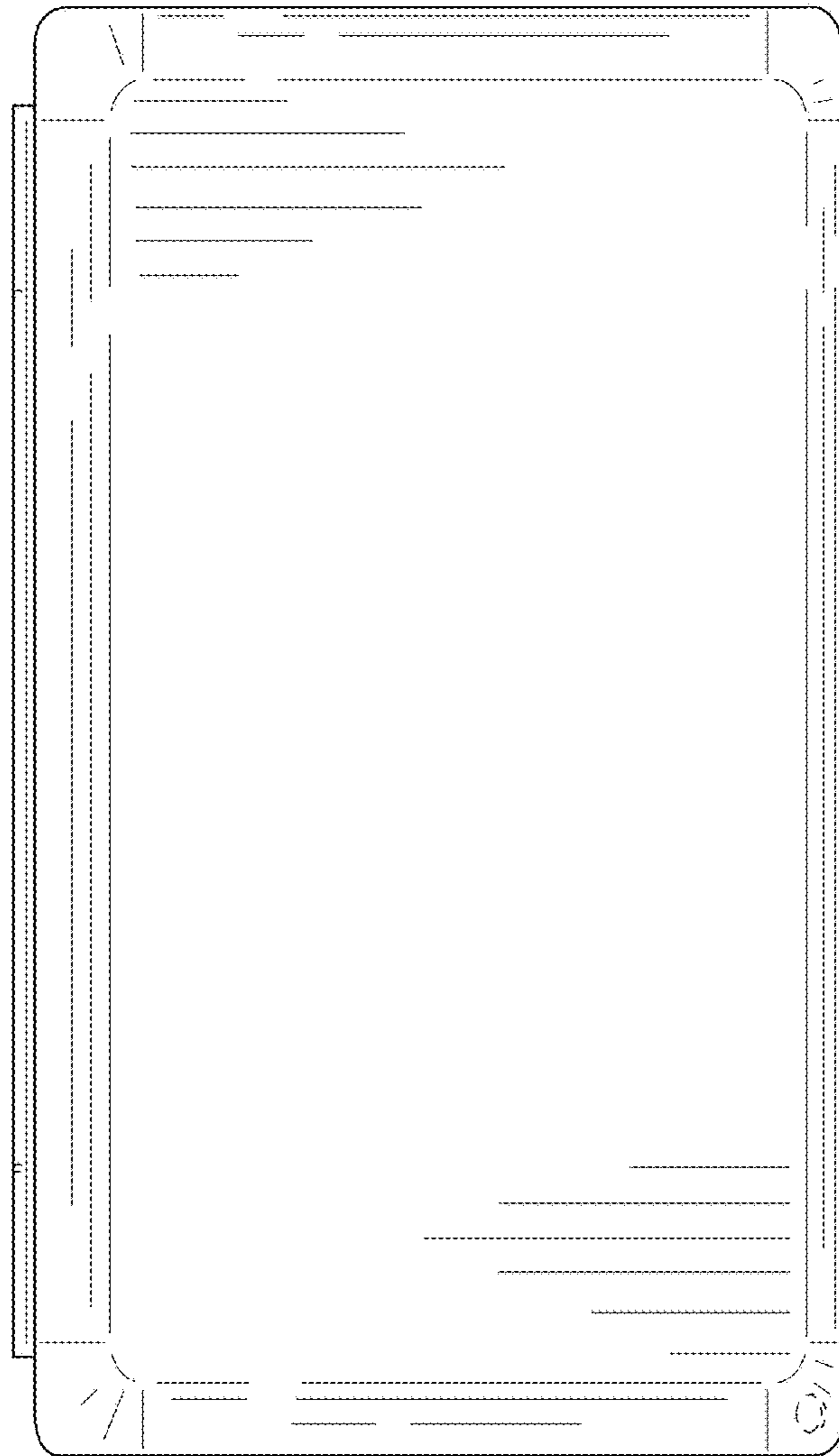

FIG. 13

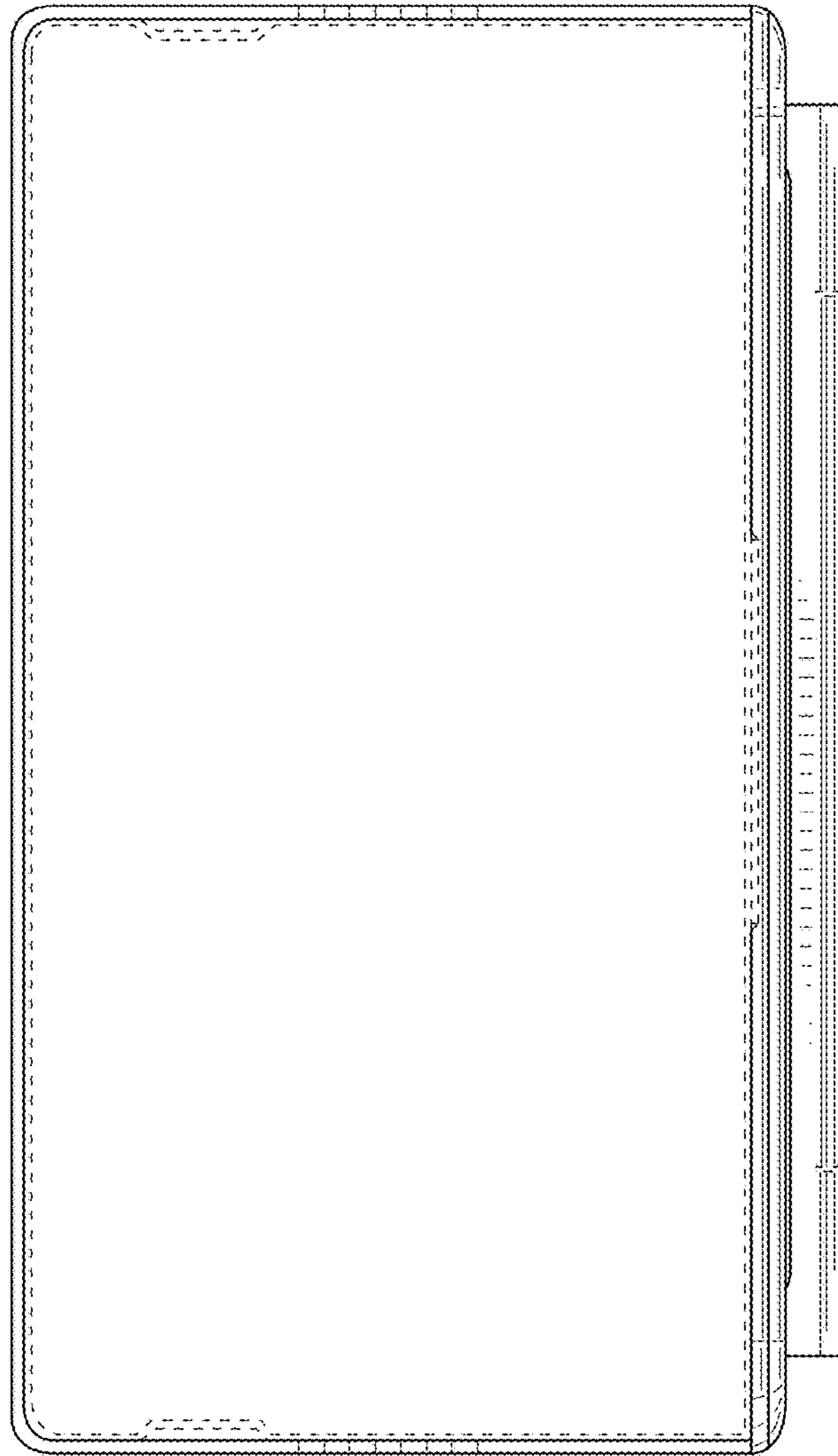

FIG. 14