



US00D865744S

(12) **United States Design Patent** (10) **Patent No.:** **US D865,744 S**
Yun (45) **Date of Patent:** **** Nov. 5, 2019**

(54) **CASE FOR ELECTRONIC COMMUNICATIONS DEVICE**

(71) Applicant: **SPIGEN KOREA CO., LTD.**, Seoul (KR)

(72) Inventor: **Sun Woo Yun**, Seoul (KR)

(73) Assignee: **SPIGEN KOREA CO., LTD.**, Seoul (KR)

(**) Term: **15 Years**

(21) Appl. No.: **29/637,148**

(22) Filed: **Feb. 14, 2018**

(51) **LOC (12) Cl.** **14-03**

(52) **U.S. Cl.**
USPC **D14/250**

(58) **Field of Classification Search**
USPC D14/248, 439, 203.3–203.7, 447, 238.1, D14/251–253, 217, 240, 250, 440;
(Continued)

(56) **References Cited**

U.S. PATENT DOCUMENTS

D574,819 S 8/2008 Andre et al.
D597,089 S * 7/2009 Khan D14/250
(Continued)

OTHER PUBLICATIONS

Spigen, "Installation video of SGP Neo Hybrid Case", <https://www.youtube.com/watch?v=mVASro4MsEg>, Published on Oct. 30, 2009, Downloaded on Feb. 21, 2019.

(Continued)

Primary Examiner — Carla J Wright

(74) *Attorney, Agent, or Firm* — Heedong Chae; Lucem, PC

(57) **CLAIM**

The ornamental design for a case for electronic communications device, as shown and described.

DESCRIPTION

FIG. 1 is a front perspective view of a case for electronic communications device showing my new design; FIG. 2 is a rear perspective view thereof; FIG. 3 is a front elevational view thereof; FIG. 4 is a rear elevational view thereof; FIG. 5 is a left side elevational view thereof; FIG. 6 is a right side elevational view thereof; FIG. 7 is a top plan view thereof; FIG. 8 is a bottom plan view thereof; FIG. 9 is a front perspective view showing the inner shell component of the case in isolation; FIG. 10 is a rear perspective view showing the inner shell component of the case in isolation; FIG. 11 is a front perspective view showing the outer frame component of the case in isolation; FIG. 12 is a rear perspective view showing the outer frame component of the case in isolation; FIG. 13 is an exploded front perspective view showing the components of the case separated; and, FIG. 14 is an exploded rear perspective view thereof.

For clarity of disclosure, the components of the case are shown in isolation in FIGS. 9-12 and separated in FIGS. 13-14. Although the case for electronic communications, in which the claimed design is embodied, consists of a transparent inner shell component and an opaque outer frame component, the claim is directed to the overall ornamental appearance of the case for electronic communications device in its entirety and does not extend to the ornamental appearance of each of the individual components.

The broken lines throughout the drawing figures depict portions of the case that form no part of the claimed design.

1 Claim, 14 Drawing Sheets

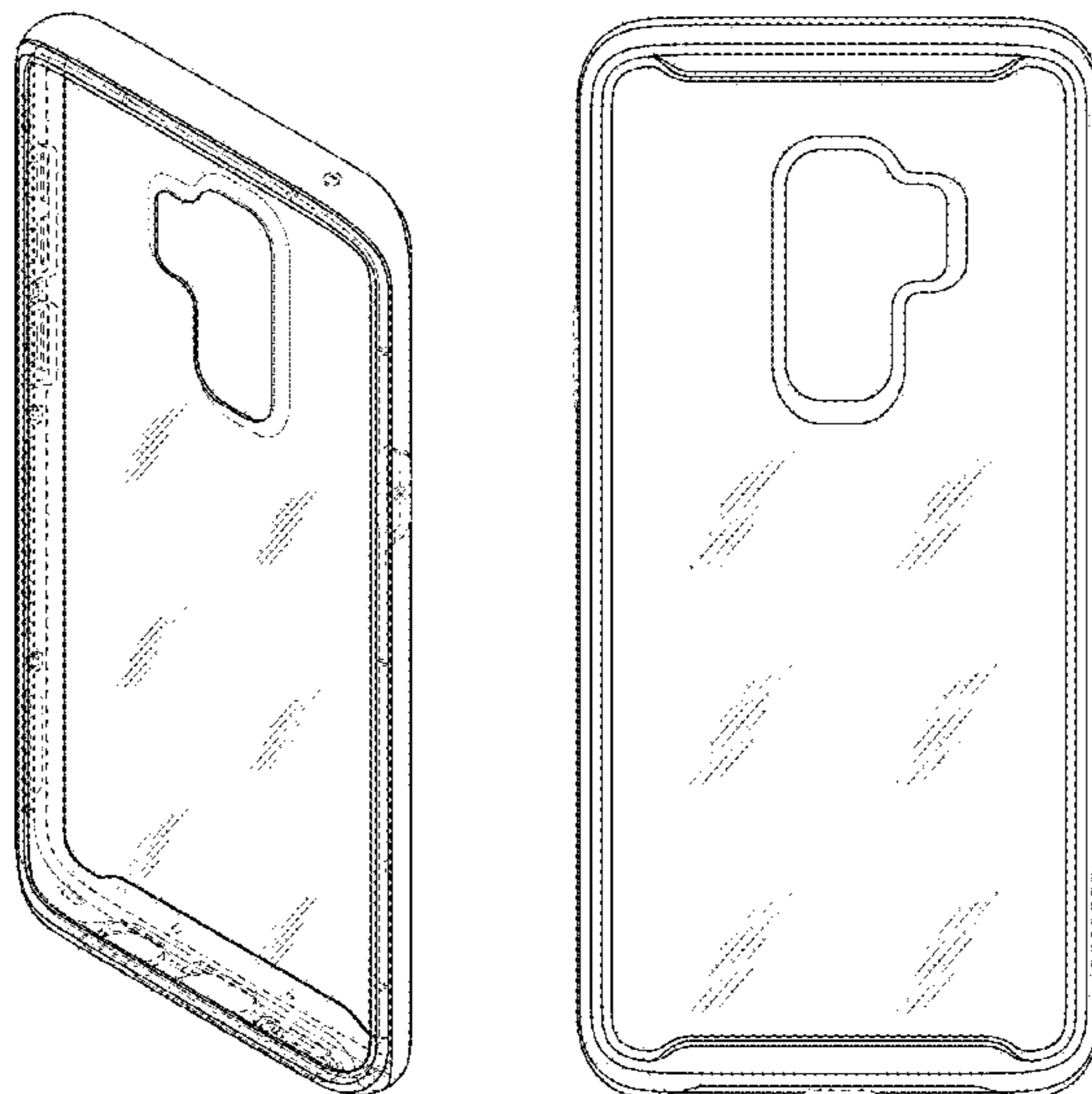

(56)

References Cited

OTHER PUBLICATIONS

“Spigen Neo Hybrid CC Galaxy S6 Case with Flexible Inner Casing and Reinforced Hard Bumper Frame for Galaxy S6 2015—Satin Silver”, <https://www.amazon.com/Spigen-Hybrid-Galaxy-Flexible-Reinforced/dp/B00UMDOZLU>, Earliest review date of Mar. 25, 2015, Downloaded on Dec. 18, 2018.

“Spigen Neo Hybrid CC Galaxy S6 Edge Case with Flexible Inner Casing and Reinforced Hard Bumper Frame for Galaxy S6 Edge 2015—Blue Topaz”, <https://www.amazon.com/Spigen-Hybrid-Galaxy-Flexible-Reinforced/dp/B00USAPGKQ>, Earliest review date of Apr. 4, 2015, Downloaded on Dec. 18, 2018.

“Spigen Neo Hybrid Carbon Galaxy S6 Edge Plus Case with Carbon Fiber Design and Reinforced Hard Bumper Frame for Galaxy S6 Edge Plus 2015—Dante Red”, <https://www.amazon.com/Spigen-Hybrid-Carbon-Galaxy-Reinforced/dp/B010MWHZS0>, Earliest review date of Aug. 18, 2015, Downloaded on Dec. 18, 2018.

“Spigen Neo Hybrid Crystal Galaxy Note 5 Case with Flexible Inner Casing and Reinforced Hard Bumper Frame for Galaxy Note 5 2015—Champagne Gold”, <https://www.amazon.com/Spigen-Hybrid-Crystal-Flexible-Reinforced/dp/B010MWIG1K>, Earliest review date of Aug. 22, 2015, Downloaded on Dec. 18, 2018.

“iPhone 6s Case, Spigen [Neo Hybrid EX] Premium Bumper [Rose Gold] Clear TPU / PC Frame Slim Dual Layer Premium Case for iPhone 6 (2014) / 6s (2015)—Rose Gold (SGP11725)”, <https://www.amazon.com/Spigen-Hybrid-iPhone-Flexible-Reinforced/dp/B012PKV30S>, Earliest review date of Aug. 28, 2015, Downloaded on Dec. 18, 2018.

“Spigen Neo Hybrid Carbon iPhone 6s Case with Carbon Fiber Design and Reinforced Hard Bumper Frame for Apple iPhone 6s / iPhone 6 (2015)—Reventon Yellow”, <https://www.amazon.com/Spigen-Hybrid-Carbon-iPhone-Reinforced/dp/B010MVJ5O8>, Earliest review date of Sep. 1, 2015, Downloaded on Dec. 18, 2018.

“Spigen Neo Hybrid iPhone 6S Case with Flexible Inner Protection and Reinforced Hard Bumper Frame for iPhone 6S 2015—Gunmetal”, <https://www.amazon.com/Spigen-Hybrid-Flexible-Protection-Reinforced/dp/B010MVIZTE>, Earliest review date of Sep. 1, 2015, Downloaded on Dec. 18, 2018.

“Spigen Neo Hybrid EX iPhone 6S Plus Case with Flexible Inner Bumper and Reinforced Hard Frame for iPhone 6S Plus/iPhone 6 Plus—Champagne Gold”, <https://www.amazon.com/Spigen-Hybrid-iPhone-Flexible-Reinforced/dp/B010MVRR16>, Earliest review date of Sep. 4, 2015, Downloaded on Dec. 18, 2018.

“iPhone 6S Plus Case, Caseology [Wavelength Series] Slim Fit Military-Grade Drop Protection [Navy Blue] for Apple iPhone 6S Plus (2015) & iPhone 6 Plus (2014)”, <https://www.amazon.com/iPhone-Caseology-Wavelength-Military-Grade-Protection/dp/B013W2C77G>, Earliest review date of Sep. 10, 2015, Downloaded on Mar. 13, 2018.

“Spigen Neo Hybrid Carbon iPhone 6S Plus Case with Carbon Fiber Design and Reinforced Hard Bumper Frame for iPhone 6S Plus 2015—Gunmetal”, <https://www.amazon.com/Spigen-Hybrid-Carbon-iPhone-Reinforced/dp/B010MVRGMQ>, Earliest review date of Sep. 11, 2015, Downloaded on Dec. 18, 2018.

“iPhone SE Case, for Apple iPhone 5S/5 Case, Rock [Royce] Antiscratch Drop Protection Slim Fit Dual Layered Heavy Duty Armor Hybrid Hard PC + Soft TPU Protective Shell Case—Champagne Gold/Black”, <https://www.amazon.com/ROCK-Antiscratch-Protection-Layered-Protective/dp/B014A8AM71>, Earliest review date of Oct. 16, 2015, Downloaded on Jan. 30, 2017.

“Spigen Neo Hybrid EX Nexus 6P Case with Flexible Inner Bumper and Reinforced Hard Frame for Nexus 6P 2015—Gunmetal”, <https://www.amazon.com/Spigen-Hybrid-Flexible-Bumper-Reinforced/dp/B0184I8Z4W>, Earliest review date of Oct. 20, 2015, Downloaded on Dec. 18, 2018.

George Tinari, “Caseology review: Testing 4 of the nicest iPhone 6s cases available”, <https://www.cultofmac.com/399325/caseology-review>, Published on Nov. 28, 2015, Downloaded on Jan. 30, 2017.

“Spigen Neo Hybrid Crystal Galaxy S7 Edge Case with Flexible Inner Casing and Reinforced Hard Bumper Frame for Samsung Galaxy S7 Edge 2016—Satin Silver”, <https://www.amazon.com/Spigen-Crystal-Flexible-Reinforced-Samsung/dp/B01A7IDQV4>, Earliest review date of Feb. 22, 2016, Downloaded on Dec. 18, 2018.

“Spigen Neo Hybrid Galaxy S7 Case with Flexible Inner Protection and Reinforced Hard Bumper Frame for Samsung Galaxy S7 2016—Gunmetal”, <https://www.amazon.com/Spigen-Flexible-Protection-Reinforced-Samsung/dp/B01B1I6J0E>, Earliest review date of Feb. 27, 2016, Downloaded on Dec. 18, 2018.

“Spigen Neo Hybrid Galaxy S7 Edge Case with Flexible Inner Protection and Reinforced Hard Bumper Frame for Samsung Galaxy S7 Edge 2016—Satin Silver”, <https://www.amazon.com/Spigen-Flexible-Protection-Reinforced-Samsung-x/dp/B01B1I6JMM>, Earliest review date of Feb. 27, 2016, Downloaded on Dec. 18, 2018.

“Spigen Neo Hybrid Crystal Galaxy S7 Case with Flexible Inner Casing and Reinforced Hard Bumper Frame for Samsung Galaxy S7 2016—Champagne Gold”, <https://www.amazon.com/Spigen-Crystal-Flexible-Reinforced-Samsung/dp/B01B29WCOY>, Earliest review date of Mar. 3, 2016, Downloaded on Dec. 18, 2018.

“Gold Apple iPhone 5 5S Hybrid Shockproof Hard Bumper Soft Case Cover Skin”, <https://web.archive.org/web/20160321221419/https://www.nywatchstore.com/goapip55shys.html>, first archived on Mar. 21, 2016 at Wayback Machine, Downloaded on Jan. 22, 2019.

“Rock PC+TPU Neo Hybrid Durable Slim Armor cover case for iPhone X 6S 5S SE Plus”, <https://www.ebay.com/itm/ROCK-PC-TPU-Neo-Hybrid-Durable-Slim-Armor-cover-case-for-iphone-X-6S-5S-SE-Plus-/111952466831>, listing first revised on Mar. 30, 2016, Downloaded on Mar. 9, 2018.

“Spigen Neo Hybrid iPhone SE Case with Flexible Inner Protection and Reinforced Hard Bumper Frame for iPhone SE 2016—Gunmetal”, <https://www.amazon.com/dp/B01BEJBBSK>, Earliest review date of Apr. 6, 2016, Downloaded on Dec. 20, 2018.

“Spigen Neo Hybrid Crystal iPhone SE Case with Flexible Inner Casing and Reinforced Hard Bumper Frame for iPhone SE 2016—Rose Gold”, <https://www.amazon.com/Spigen-Hybrid-Crystal-Flexible-Reinforced/dp/B01BEJB7TI>, Earliest review date of Apr. 7, 2016, Downloaded on Dec. 18, 2018.

“Spigen Neo Hybrid Crystal LG G5 Case with Flexible Inner Casing and Reinforced Hard Bumper Frame for LG G5 2016—Champagne Gold”, <https://www.amazon.com/Spigen-Hybrid-Crystal-Flexible-Reinforced/dp/B01B1GQKIC>, Earliest review date of Apr. 17, 2016, Downloaded on Dec. 18, 2018.

“Spigen Neo Hybrid OnePlus 3 Case/OnePlus 3T Case with Flexible Inner Protection and Reinforced Hard Bumper Frame for OnePlus 3 2016—Gunmetal”, <https://www.amazon.com/Spigen-OnePlus-Flexible-Protection-Reinforced/dp/B01H3PF76Q>, Earliest review date of Aug. 9, 2016, Downloaded on Dec. 18, 2018.

“Rock Royce Hybrid Case for Apple iPhone 5 5S & SE Iron Grey”, <https://www.gadgetwear.co.uk/products/rock-royce-hybrid-case-for-apple-iphone-5-5s-se-iron-grey>, Earliest review date of Aug. 26, 2016, Downloaded on Mar. 9, 2018.

“Spigen Neo Hybrid Crystal iPhone 7 Plus Case with Flexible Casing and Hard Bumper Frame for Apple iPhone 7 Plus 2016—Champagne Gold”, <https://www.amazon.com/Spigen-Hybrid-Crystal-iPhone-Flexible/dp/B01GIWHKXI>, Earliest review date of Sep. 8, 2016, Downloaded on Dec. 18, 2018.

“Spigen Neo Hybrid iPhone 7 Case with Flexible Inner Protection and Reinforced Hard Bumper Frame for iPhone 7 2016—Gunmetal”, <https://www.amazon.com/Spigen-Hybrid-Flexible-Protection-Reinforced/dp/B01GIVXKUG>, Earliest review date of Sep. 8, 2016, Downloaded on Dec. 18, 2018.

“Caseology Parallax Series iPhone 7 Plus / 8 Plus Cover Case with Design Slim Protective for Apple iPhone 7 Plus (2016)/ iPhone 8 Plus (2017)—Matte Black”, https://www.amazon.com/dp/B01LY50PST/ref=sspa_dk_detail_2?psc=1&pd_rd_i=B01LY50PST, Earliest review date of Sep. 9, 2016, Downloaded on Mar. 13, 2018.

“Spigen Neo Hybrid Crystal iPhone 7 Case with Flexible Inner Casing and Reinforced Hard Bumper Frame for iPhone 7 2016—Rose Gold”, <https://www.amazon.com/Spigen-Hybrid-Crystal-Flexible-Reinforced/dp/B01GIVXVN2>, Earliest review date of Sep. 14, 2016, Downloaded on Dec. 18, 2018.

“Spigen Neo Hybrid iPhone 7 Plus Case with Flexible Inner Protection and Hard Bumper Frame for Apple iPhone 7 Plus (2016)—Gunmetal”, <https://www.amazon.com/Spigen-Hybrid-iPhone->

(56)

References Cited

OTHER PUBLICATIONS

Flexible-Protection/dp/B01GIWH6H8, Earliest review date of Sep. 14, 2016, Downloaded on Dec. 18, 2018.

“Spigen Neo Hybrid Google Pixel XL Case with Flexible Inner Protection and Reinforced Hard Bumper Frame for Google Pixel XL 2016—Satin Silver”, <https://www.amazon.com/Spigen-Hybrid-Flexible-Protection-Reinforced/dp/B01LZW1LW3>, Earliest review date of Oct. 23, 2016, Downloaded on Dec. 18, 2018.

“Spigen Neo Hybrid Crystal Google Pixel Case with Flexible Inner Casing and Reinforced Hard Bumper Frame for Google Pixel 2016—Gunmetal”, <https://www.amazon.com/dp/B01M03SL8Y>, Earliest review date of Dec. 14, 2016, Downloaded on Dec. 18, 2018.

“Spigen Neo Hybrid Crystal Google Pixel XL Case with Flexible Inner Casing and Reinforced Hard Bumper Frame for Google Pixel XL 2016—Gunmetal”, <https://www.amazon.com/Spigen-Hybrid-Crystal-Flexible-Reinforced/dp/B01LZS6PON>, Earliest review date of Dec. 15, 2016, Downloaded on Dec. 18, 2018.

“Spigen Neo Hybrid Google Pixel Case with Flexible Inner Protection and Reinforced Hard Bumper Frame for Google Pixel 2016—Blue”, <https://www.amazon.com/Spigen-Hybrid-Flexible-Protection-Reinforced/dp/B01N3VR9EA>, Earliest review date of Jan. 10, 2017, Downloaded on Dec. 10, 2018.

“Spigen Neo Hybrid Huawei Y6 Case with Flexible Inner Protection and Reinforced Hard Bumper Frame for Huawei Y6 2015—Champagne Gold”, <https://www.amazon.com/Spigen-Hybrid-Flexible-Protection-Reinforced/dp/B0182SKWUO>, Earliest review date of Feb. 13, 2017, Downloaded on Dec. 18, 2018.

* cited by examiner

FIG. 1

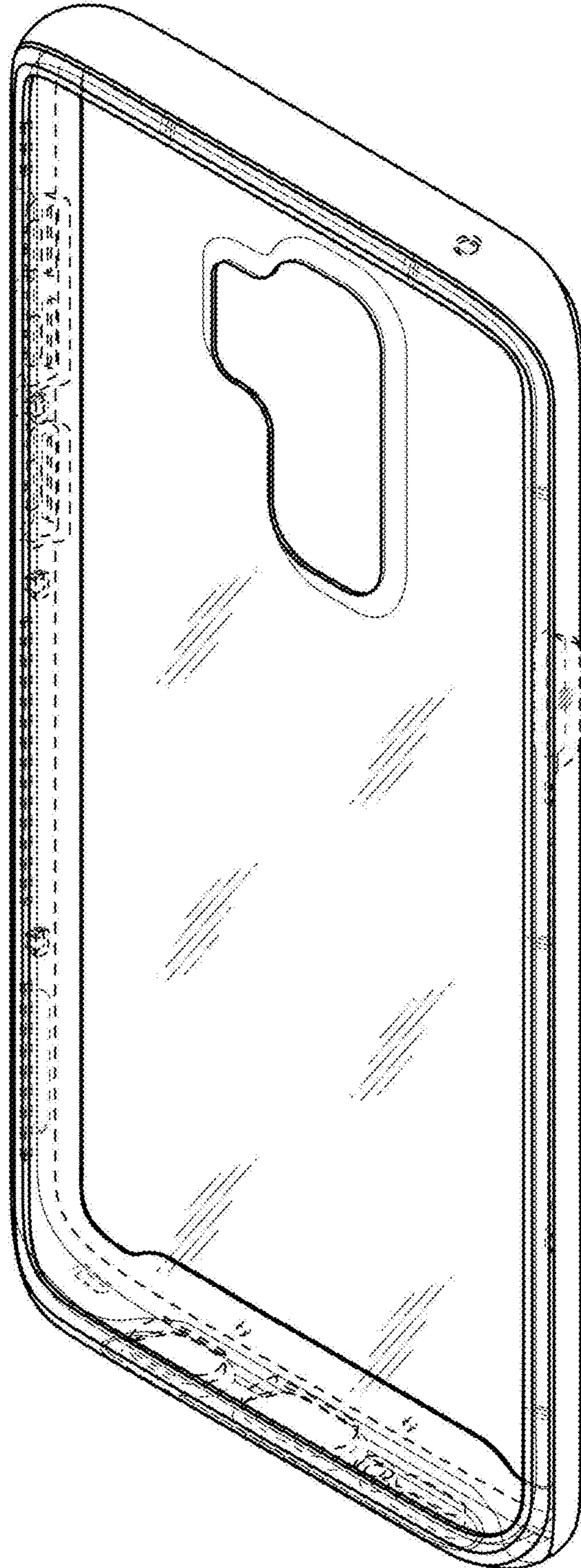

FIG. 2

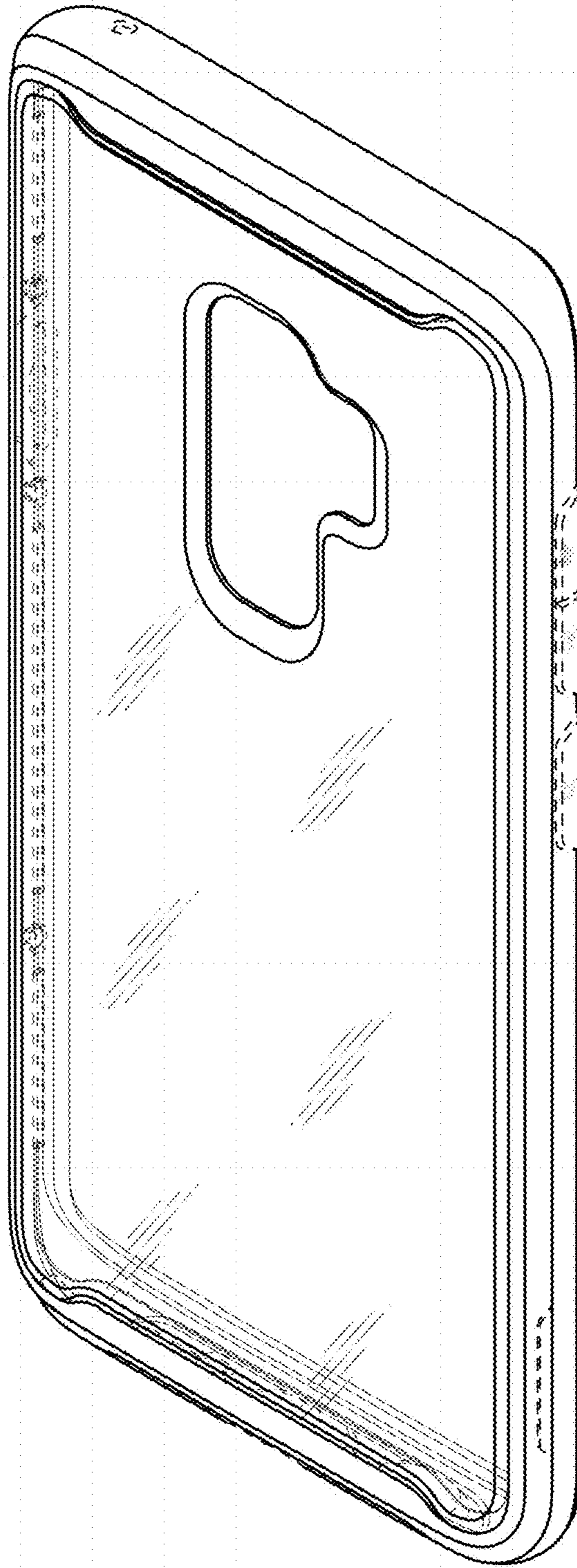

FIG. 3

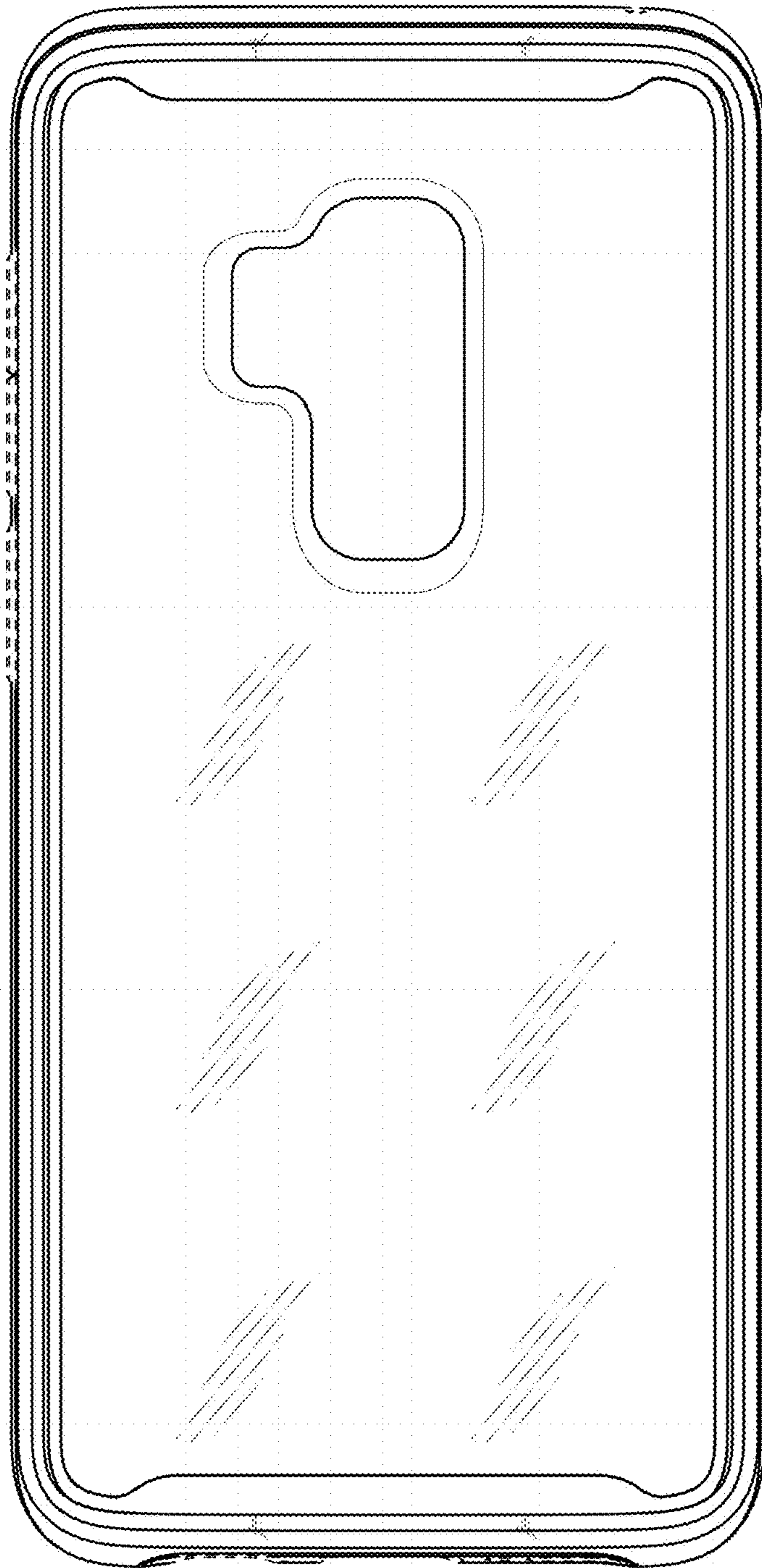

FIG. 4

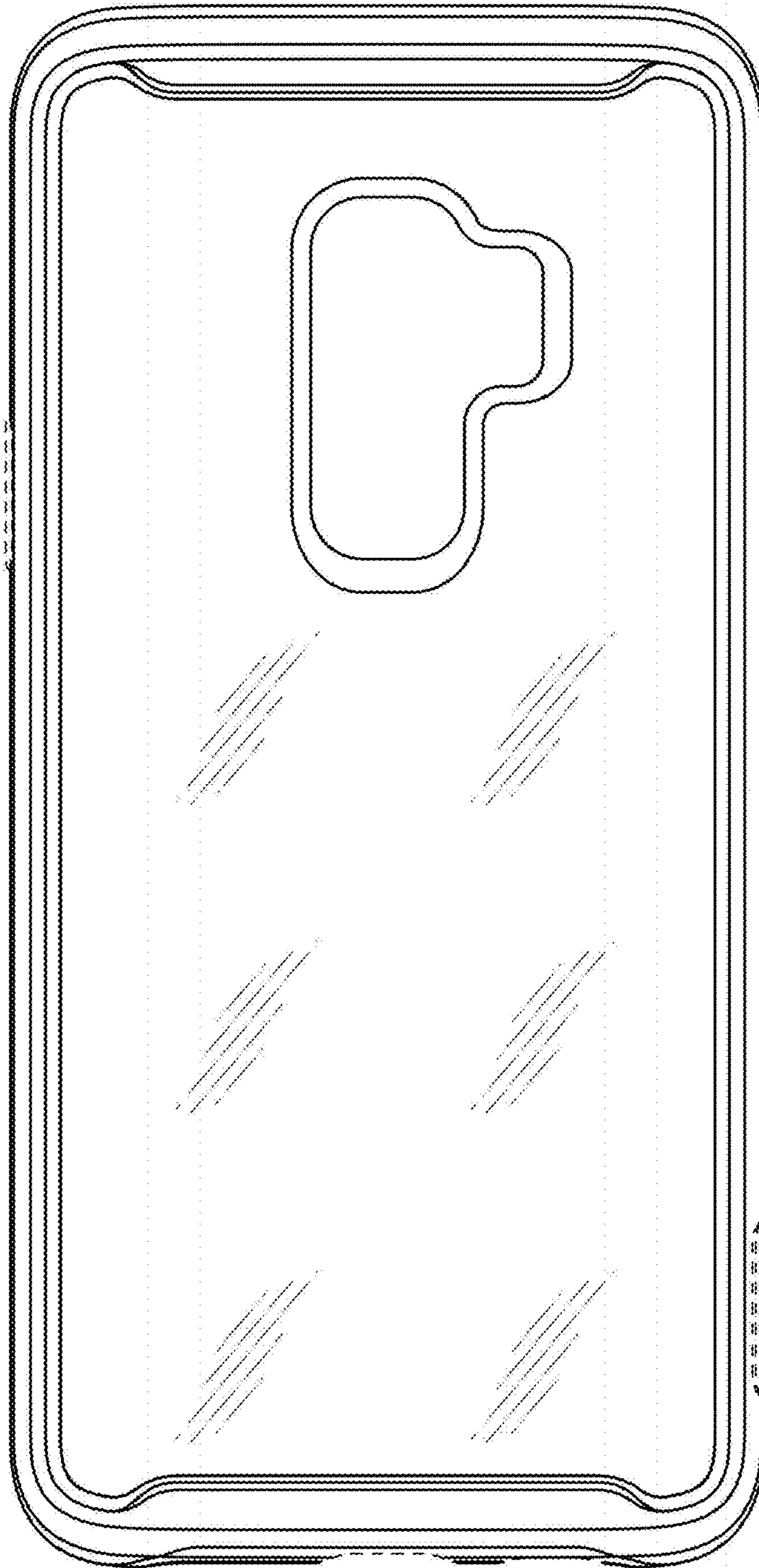

FIG. 5

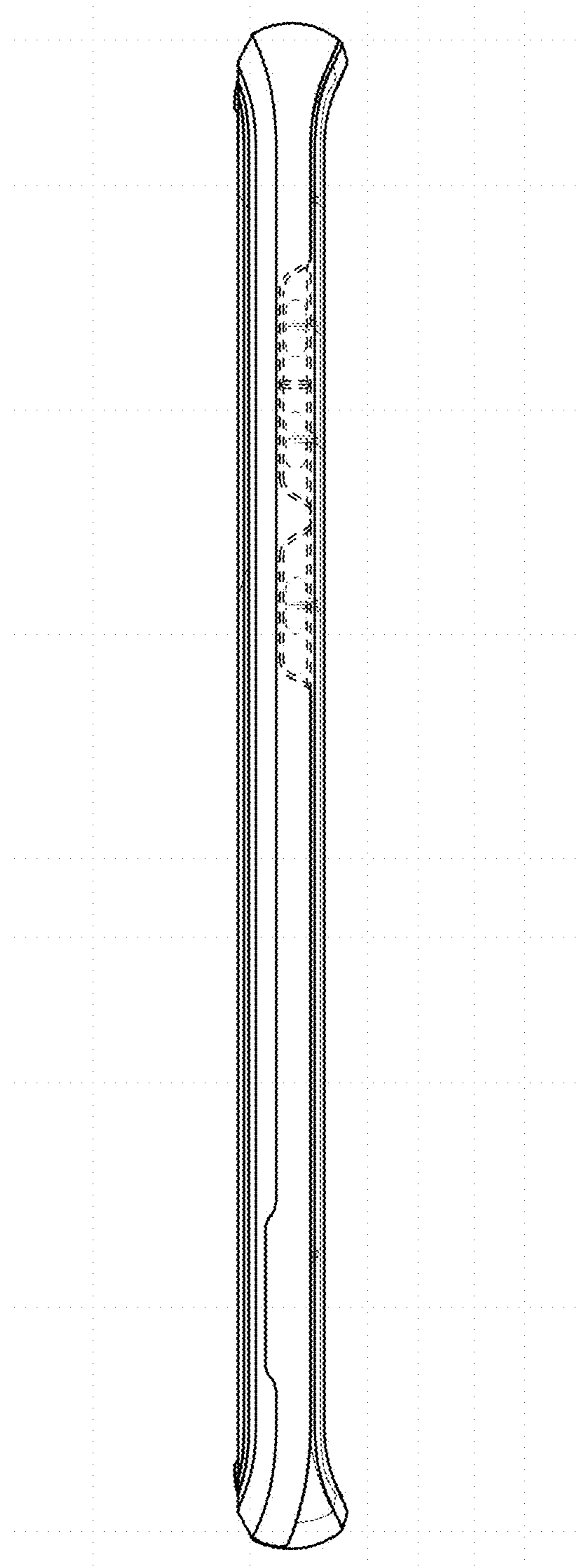

FIG. 6

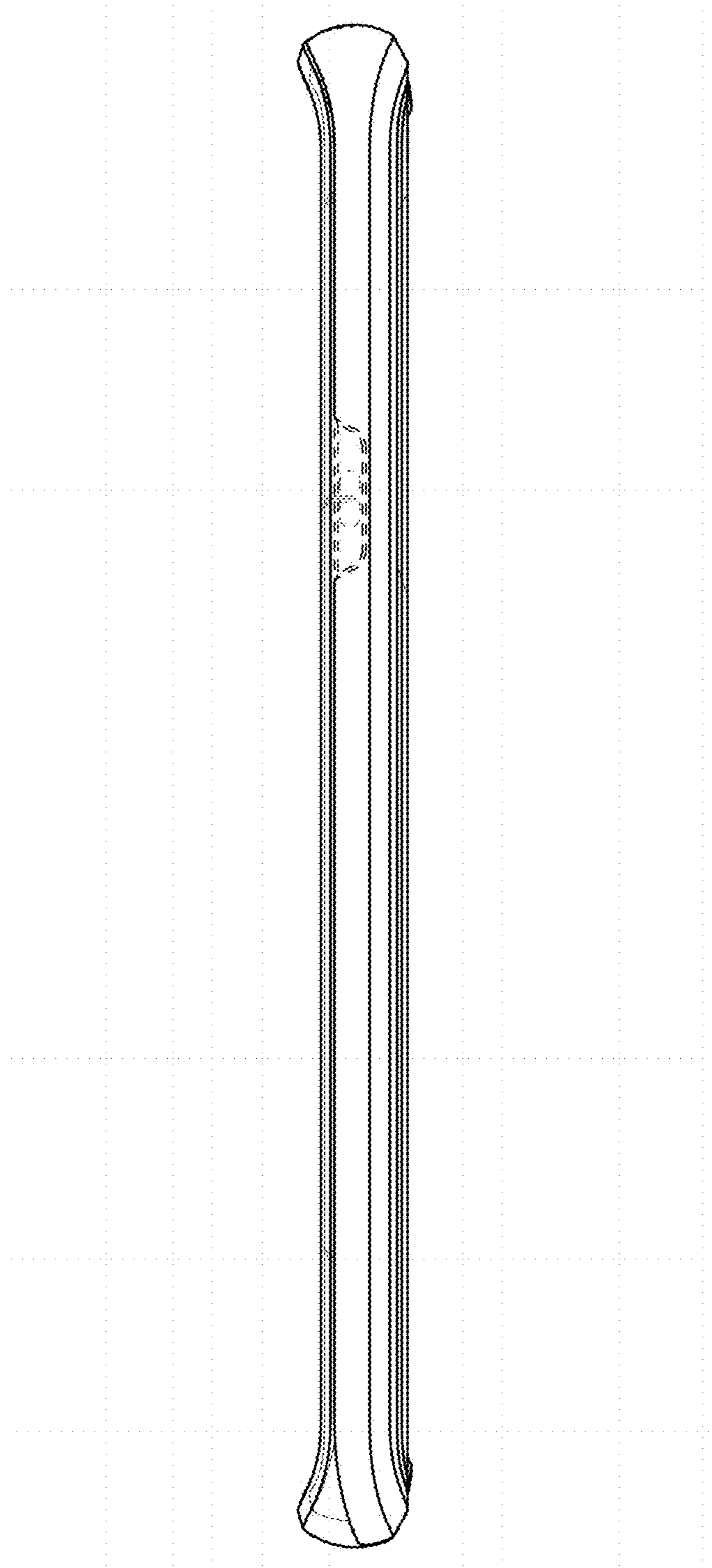

FIG. 7

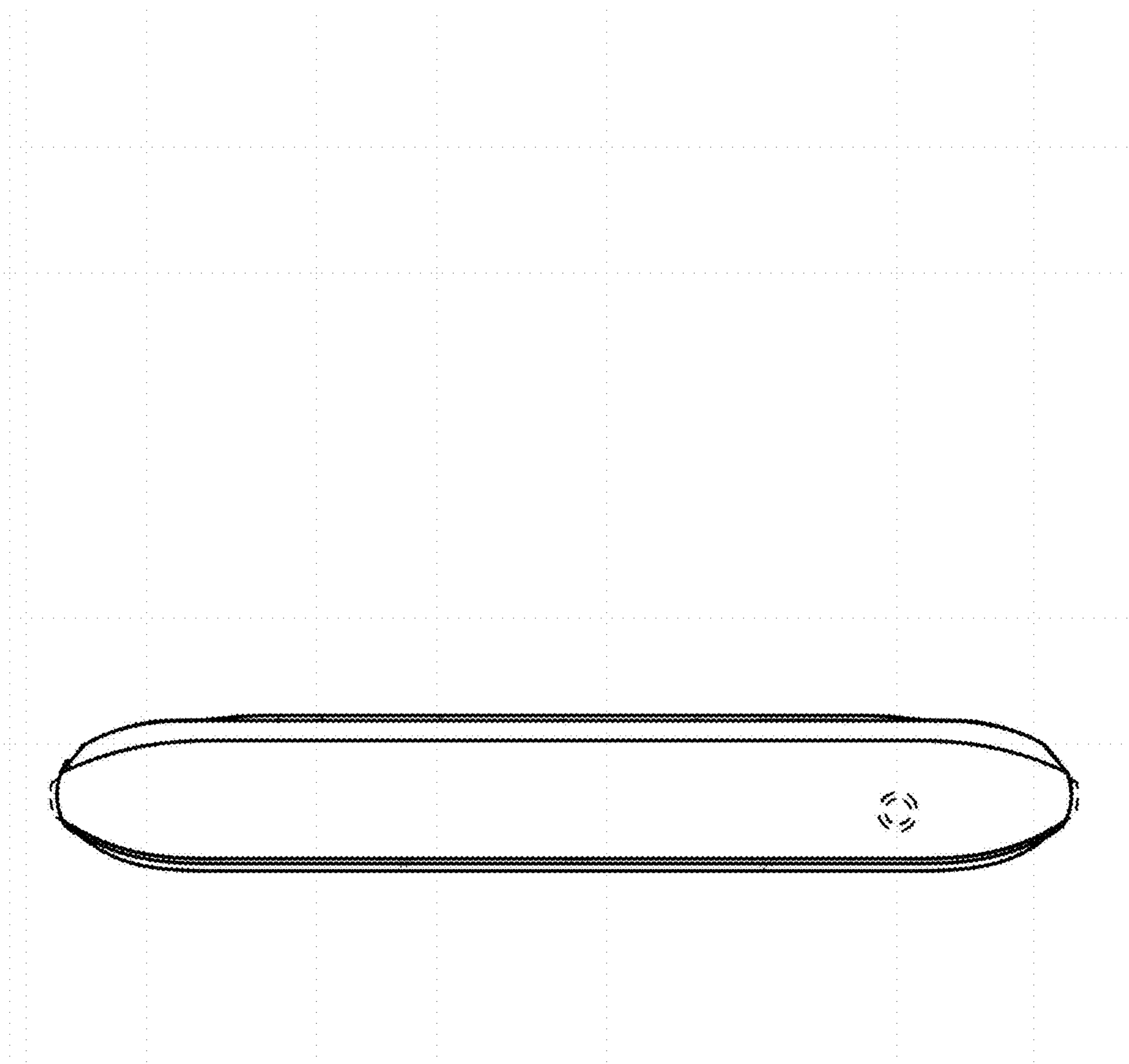

FIG. 8

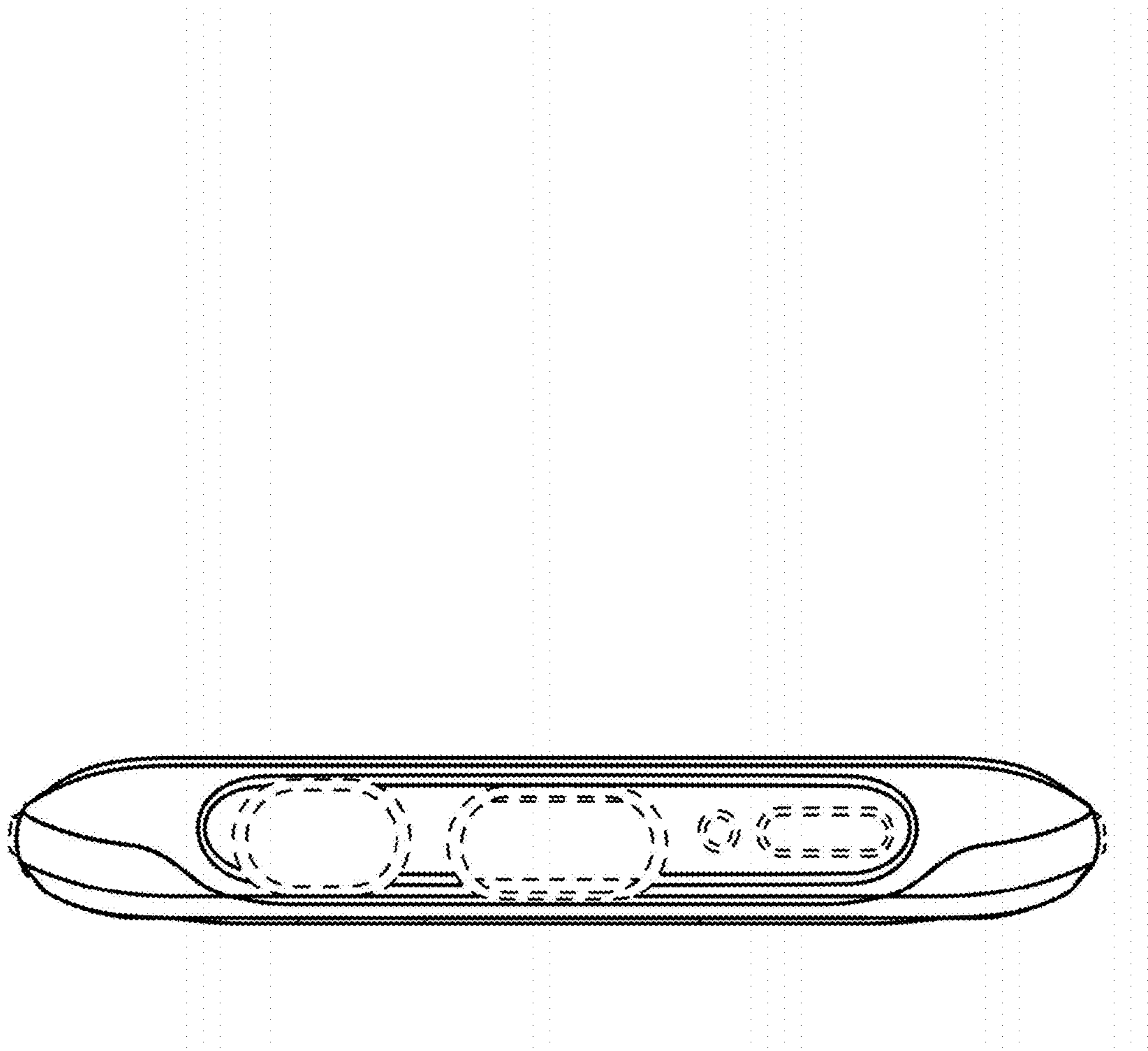

FIG. 9

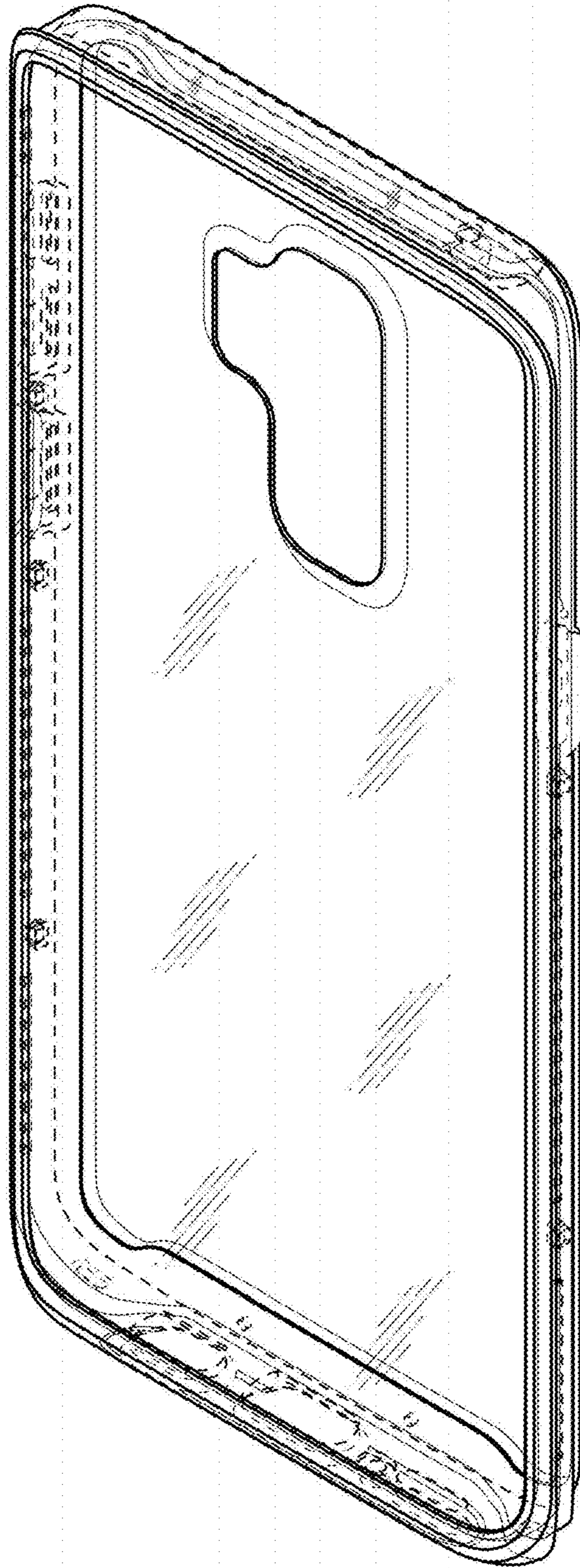

FIG. 10

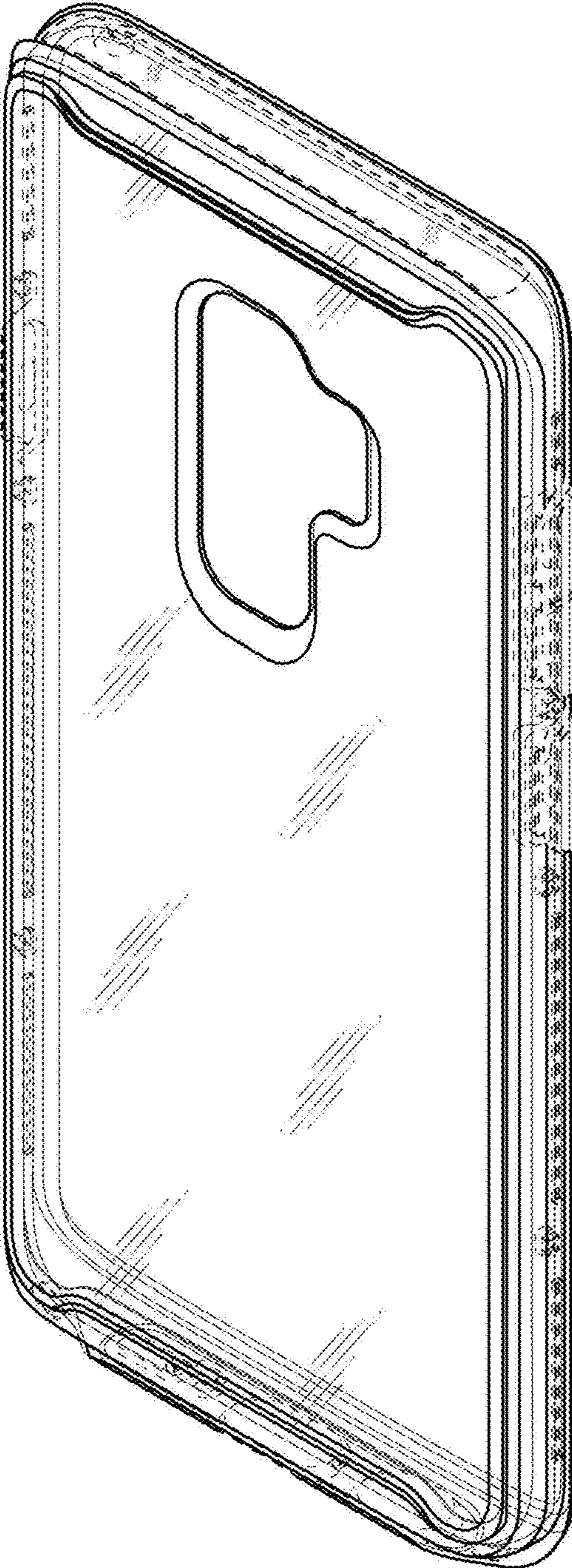

FIG. 11

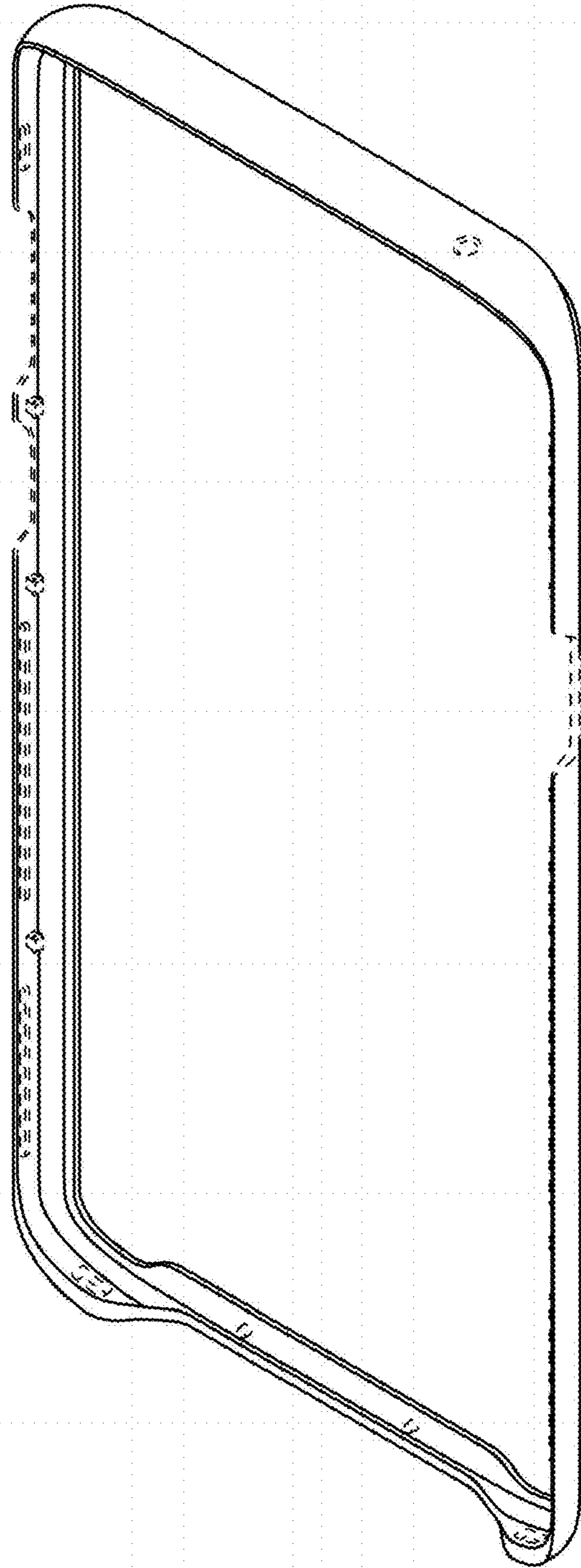

FIG. 12

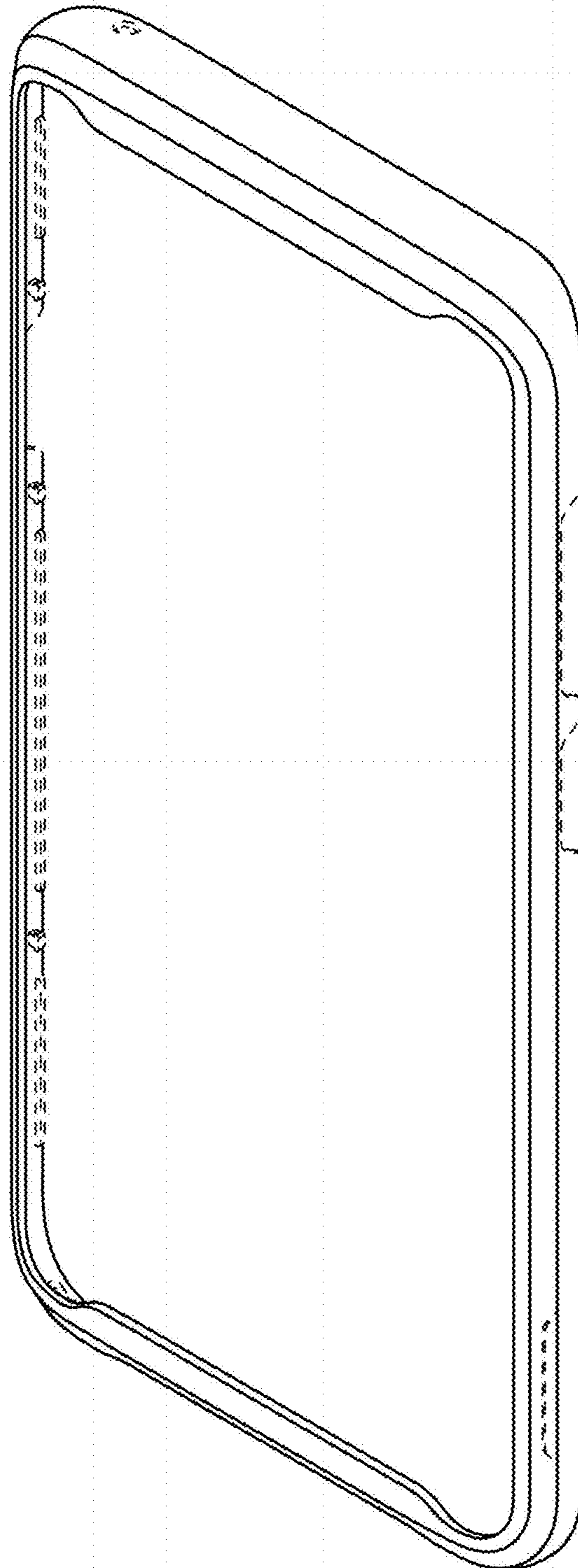

FIG. 13

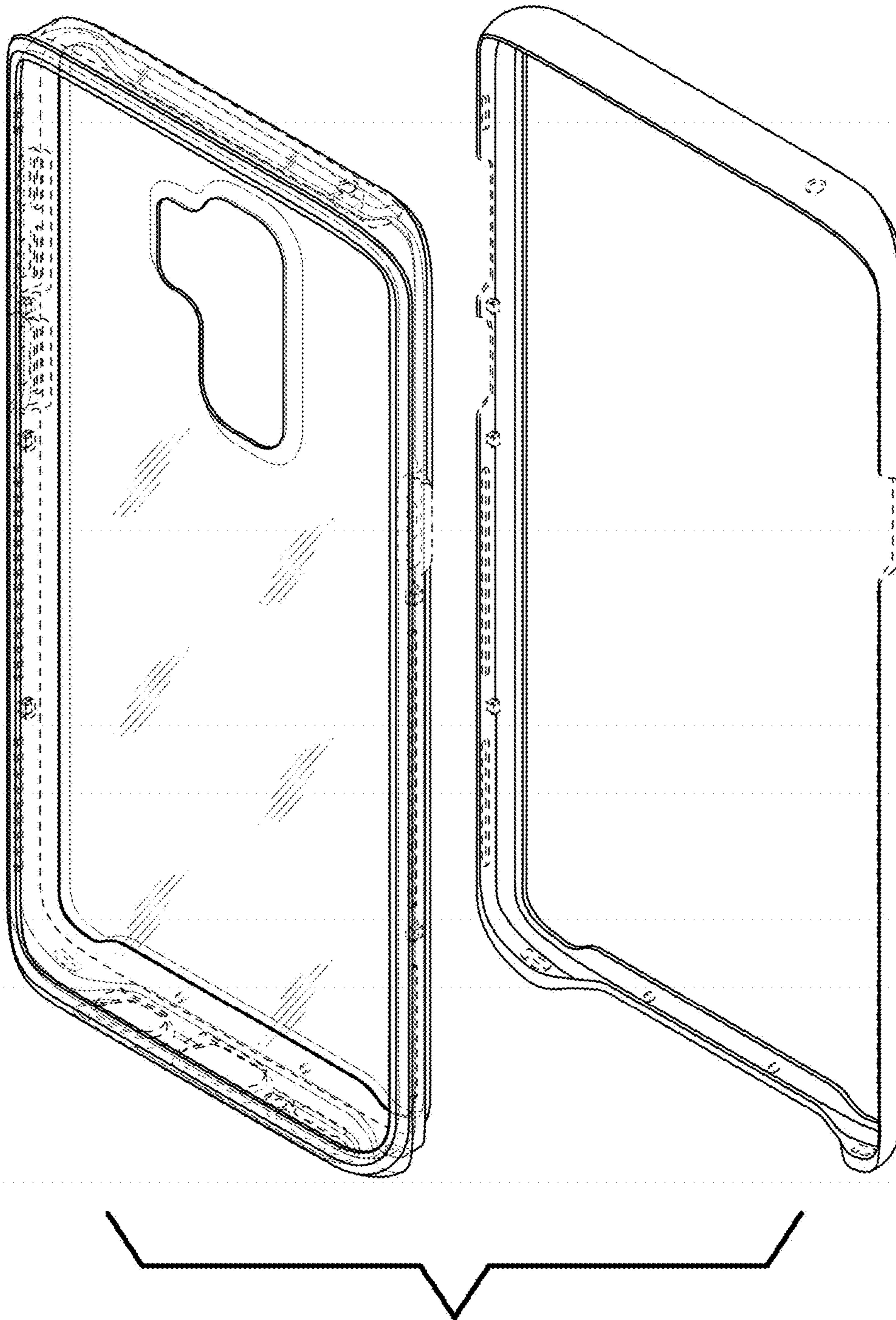

FIG. 14

