



US00D865705S

(12) **United States Design Patent**  
**Distefano**

(10) **Patent No.:** **US D865,705 S**

(45) **Date of Patent:** **\*\* Nov. 5, 2019**

(54) **LOUDSPEAKER**

(71) Applicant: **Harman International Industries, Incorporated**, Northridge, CA (US)

(72) Inventor: **Dario Distefano**, Shenzhen (CN)

(73) Assignee: **Harman International Industries, Incorporated**, Northridge, CA (US)

(\*\*) Term: **15 Years**

(21) Appl. No.: **29/628,769**

(22) Filed: **Dec. 7, 2017**

(51) **LOC (12) Cl.** ..... **14-01**

(52) **U.S. Cl.**  
USPC ..... **D14/204**

(58) **Field of Classification Search**  
USPC ..... D14/167, 168, 170–172, 188, 194–198,  
D14/204, 207, 209.1, 210–216, 219, 221,  
(Continued)

(56) **References Cited**

**U.S. PATENT DOCUMENTS**

D551,656 S \* 9/2007 Ritsher ..... D14/216  
D566,730 S \* 4/2008 Lee ..... D14/188

(Continued)

**FOREIGN PATENT DOCUMENTS**

CN 201674658 \* 12/2010 ..... H04R 9/02

**OTHER PUBLICATIONS**

JBL Xtreme Portable Wireless Bluetooth Speaker (Black), Amazon.com, Date first listed Amazon: Sep. 1, 2015, [online], [site visited May 23, 2019]. URL: <https://www.amazon.com/JBL-Portable-Wireless-Bluetooth-Speaker/dp/B014QQAM8I> (Year: 2015).\*

(Continued)

*Primary Examiner* — T Chase Nelson  
*Assistant Examiner* — Jonathan J. Han

(74) *Attorney, Agent, or Firm* — Plumsea Law Group, LLC

(57) **CLAIM**

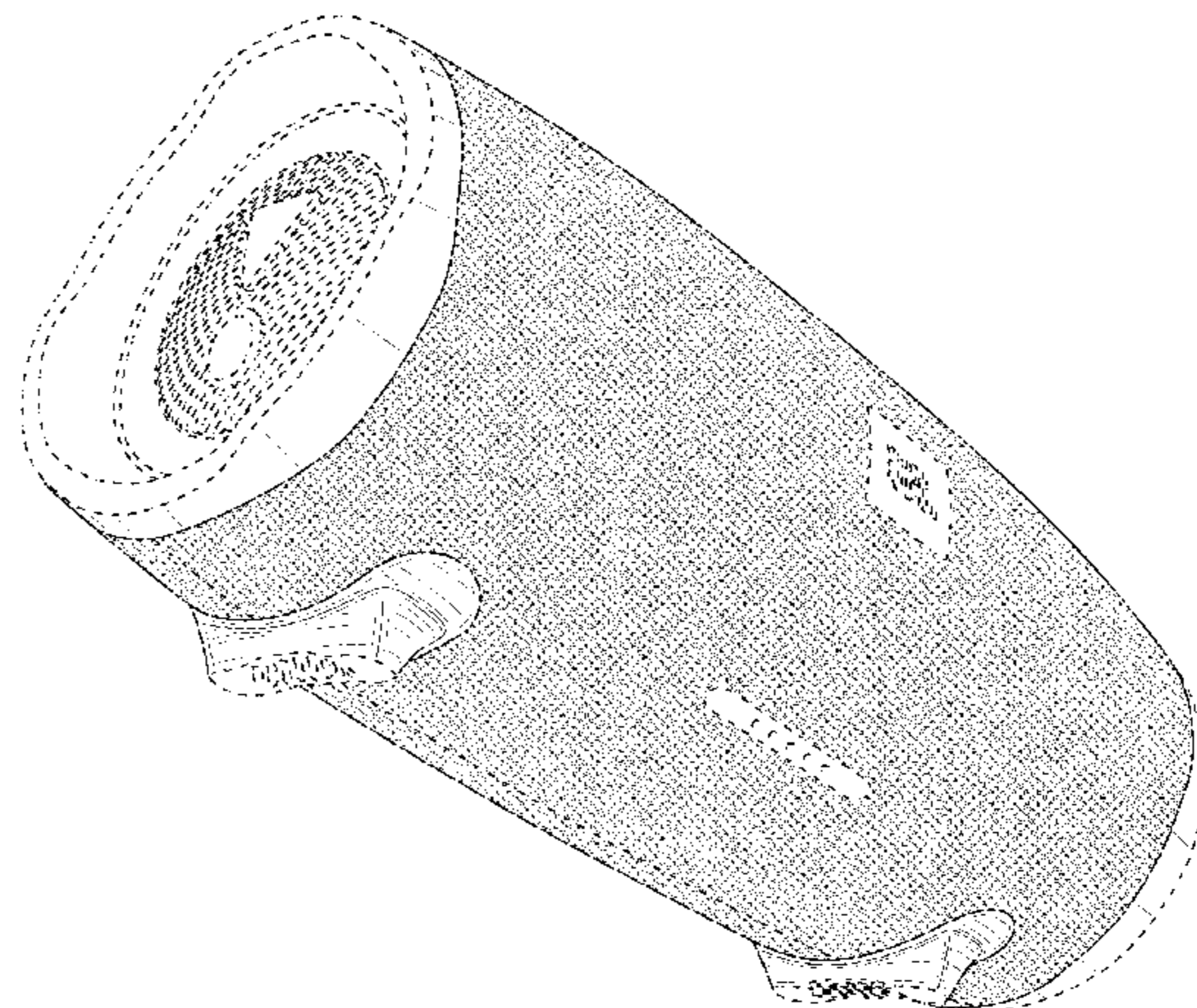
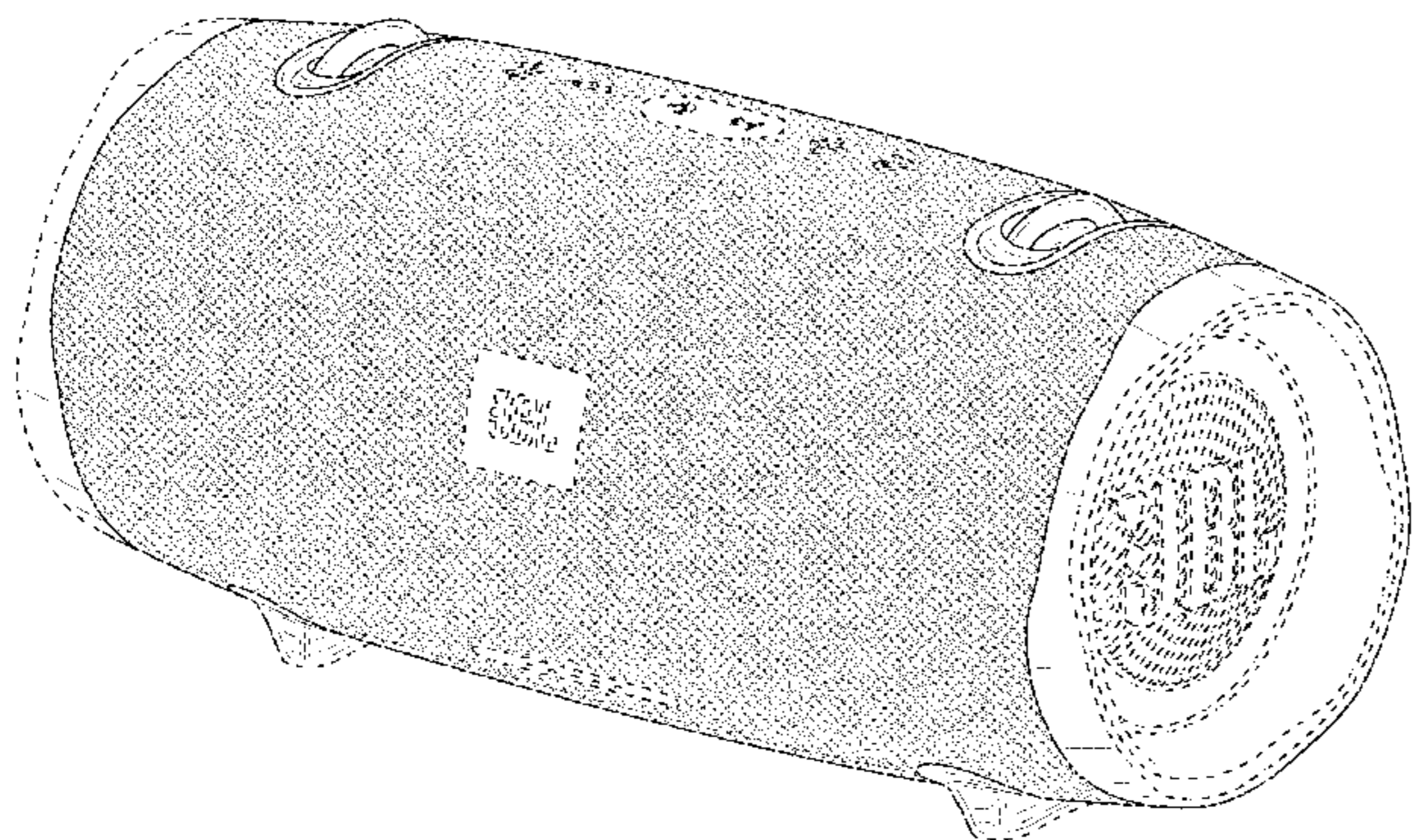
The ornamental design for a loudspeaker, as shown and described.

**DESCRIPTION**

FIG. 1 is a perspective view of a loudspeaker showing the new design;  
FIG. 2 is another perspective view thereof;  
FIG. 3 is a front elevational view thereof;  
FIG. 4 is a rear elevational view thereof;  
FIG. 5 is a side elevational view thereof;  
FIG. 6 is an opposite side elevational view thereof;  
FIG. 7 is a top view thereof;  
FIG. 8 is a bottom view thereof;  
FIG. 9 is a perspective view of another embodiment of a loudspeaker showing the new design;  
FIG. 10 is another perspective view thereof;  
FIG. 11 is a front elevational view thereof;  
FIG. 12 is a rear elevational view thereof;  
FIG. 13 is a side elevational view thereof;  
FIG. 14 is an opposite side elevational view thereof;  
FIG. 15 is a top view thereof; and,  
FIG. 16 is a bottom view thereof.

The broken lines and unshaded areas form no part of the claimed design. In FIGS. 1-8, the shading on the loudspeaker is provided merely to represent contours of the design and does not connote the character of the surfaces such as any specific texture, material, gloss, translucence, transparency, surface treatment, or surface decoration. In FIGS. 9-14, the shading on the top hook covers and the bottom feet represents translucent material, with the features (e.g., the bar) inside shown in broken lines; all other shading on the loudspeaker in FIGS. 9-14 is provided merely to represent contours of the design and does not connote the character of the surfaces such as any specific texture, material, gloss, translucence, transparency, surface treatment, or surface decoration.

**1 Claim, 16 Drawing Sheets**



(58) **Field of Classification Search**

USPC ..... D14/222, 224, 496; 181/143, 144, 147,  
181/148, 150, 153, 157, 198, 199;  
369/6–12; 381/300–303, 306, 332–334,  
381/336, 345, 361–364, 386–388  
CPC ..... B60R 11/0217; G06F 1/1688; G10K 9/22;  
G10K 11/004; H03F 1/327; H04M 1/03;  
H04M 1/035; H04N 5/642; H04N  
21/4852; H04S 3/00; H04S 7/30; H04R  
1/02; H04R 1/06; H04R 1/021; H04R  
1/025; H04R 1/026; H04R 1/028; H04R  
1/105; H04R 1/323; H04R 1/403; H04R  
1/2803; H04R 1/2834; H04R 5/02; H04R  
7/20; H04R 9/06; H04R 9/025; H04R  
2201/021; H04R 2400/00; H04R 2400/07;  
H04R 2499/11; H04R 2499/13; H04R  
2499/15

See application file for complete search history.

(56) **References Cited**

U.S. PATENT DOCUMENTS

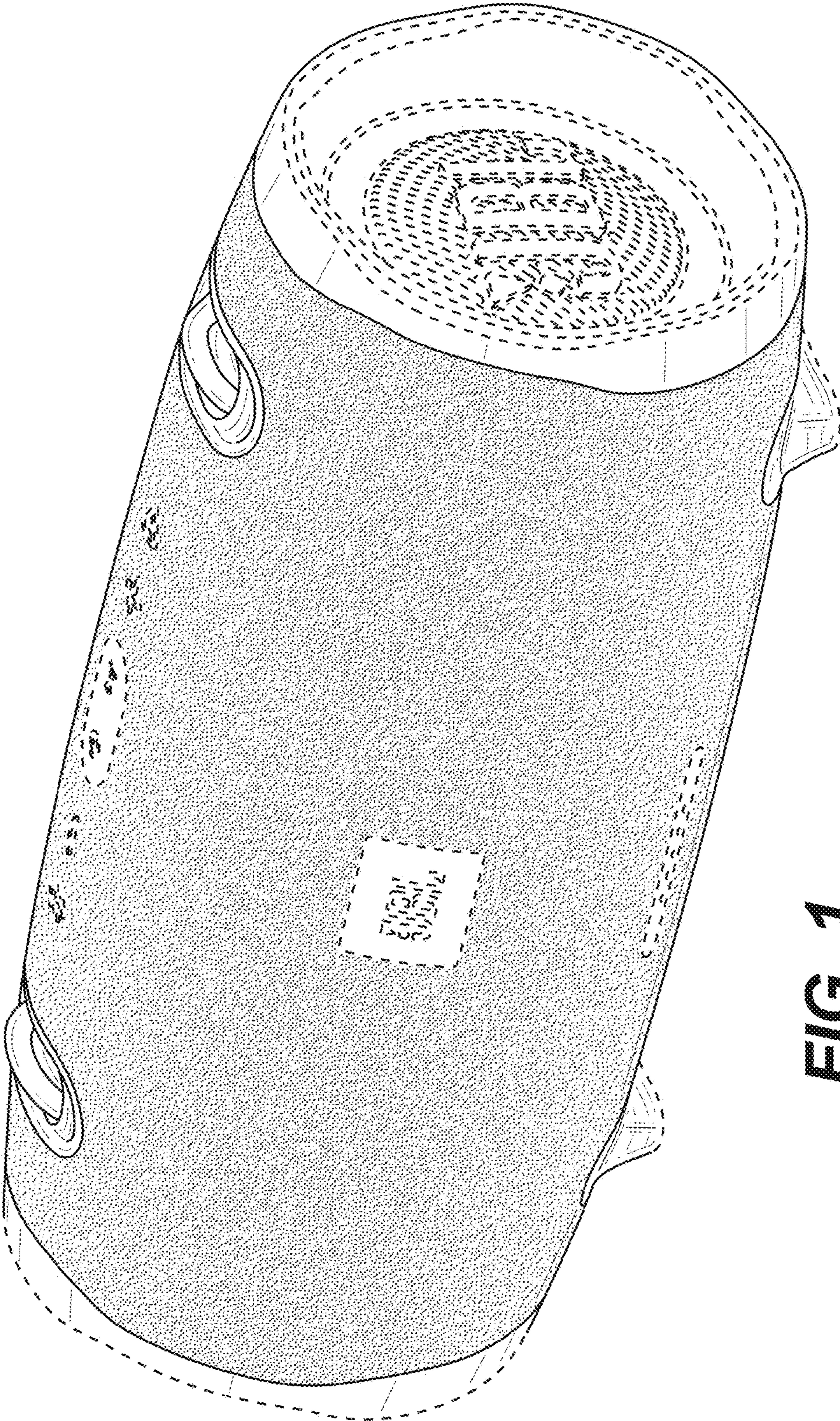
D570,847 S \* 6/2008 Chern ..... D14/434  
D571,359 S \* 6/2008 Chang ..... D14/216  
D573,579 S \* 7/2008 Yamaguchi ..... D14/168  
D598,899 S \* 8/2009 Tkachuk ..... D14/216  
D607,878 S \* 1/2010 Murray ..... D14/216  
D611,450 S \* 3/2010 Miyazaki ..... D14/209.1  
D616,420 S \* 5/2010 Morimoto ..... D14/216  
D644,206 S \* 8/2011 Ponnert ..... D14/216  
D670,271 S \* 11/2012 Tzeng ..... D14/216  
D685,765 S 7/2013 Yagihashi et al.  
D698,753 S 2/2014 Yiu et al.  
D715,262 S 10/2014 Nakamura  
D718,279 S 11/2014 Yoon et al.  
D719,137 S \* 12/2014 Cheng ..... D14/216  
D722,595 S 2/2015 Mackiewicz et al.  
D726,155 S 4/2015 Cheng et al.  
D726,684 S 4/2015 Schmiedbauer  
D726,686 S 4/2015 Yoon  
D727,298 S \* 4/2015 Chang ..... D14/216  
D730,323 S \* 5/2015 Brunner ..... D14/216

D731,467 S \* 6/2015 Brunner ..... D14/216  
D742,358 S 11/2015 Alves et al.  
D748,074 S 1/2016 Schmiedbauer  
D748,076 S 1/2016 Yoon  
D750,597 S 3/2016 Fischer et al.  
D753,630 S 4/2016 Kim  
D755,161 S \* 5/2016 Brunner ..... D14/216  
D758,348 S \* 6/2016 Lukic ..... D14/216  
D759,632 S 6/2016 Fischer et al.  
D762,621 S 8/2016 Bolton  
D763,831 S 8/2016 Cherry, II  
D778,956 S 2/2017 Langhammer et al.  
D780,153 S \* 2/2017 Lukic ..... D14/204  
D788,070 S 5/2017 Lukic et al.  
D793,993 S \* 8/2017 Song ..... D14/214  
D798,268 S \* 9/2017 Fang ..... D14/216  
D800,699 S 10/2017 Fisher et al.  
D801,310 S \* 10/2017 Kachwalla ..... D14/216  
D803,813 S \* 11/2017 Rouffiat ..... D14/216  
D805,059 S 12/2017 Fisher et al.  
D811,367 S \* 2/2018 Vaclavik ..... D14/216  
D811,368 S \* 2/2018 Fischer ..... D14/216  
D816,064 S \* 4/2018 Wei ..... D14/215  
D828,323 S \* 9/2018 Demin ..... D14/172  
D831,002 S \* 10/2018 Distefano ..... D14/216  
D834,001 S \* 11/2018 Jeon ..... D14/216  
D839,855 S \* 2/2019 Park ..... D14/216  
D842,275 S \* 3/2019 Brunner ..... D14/216

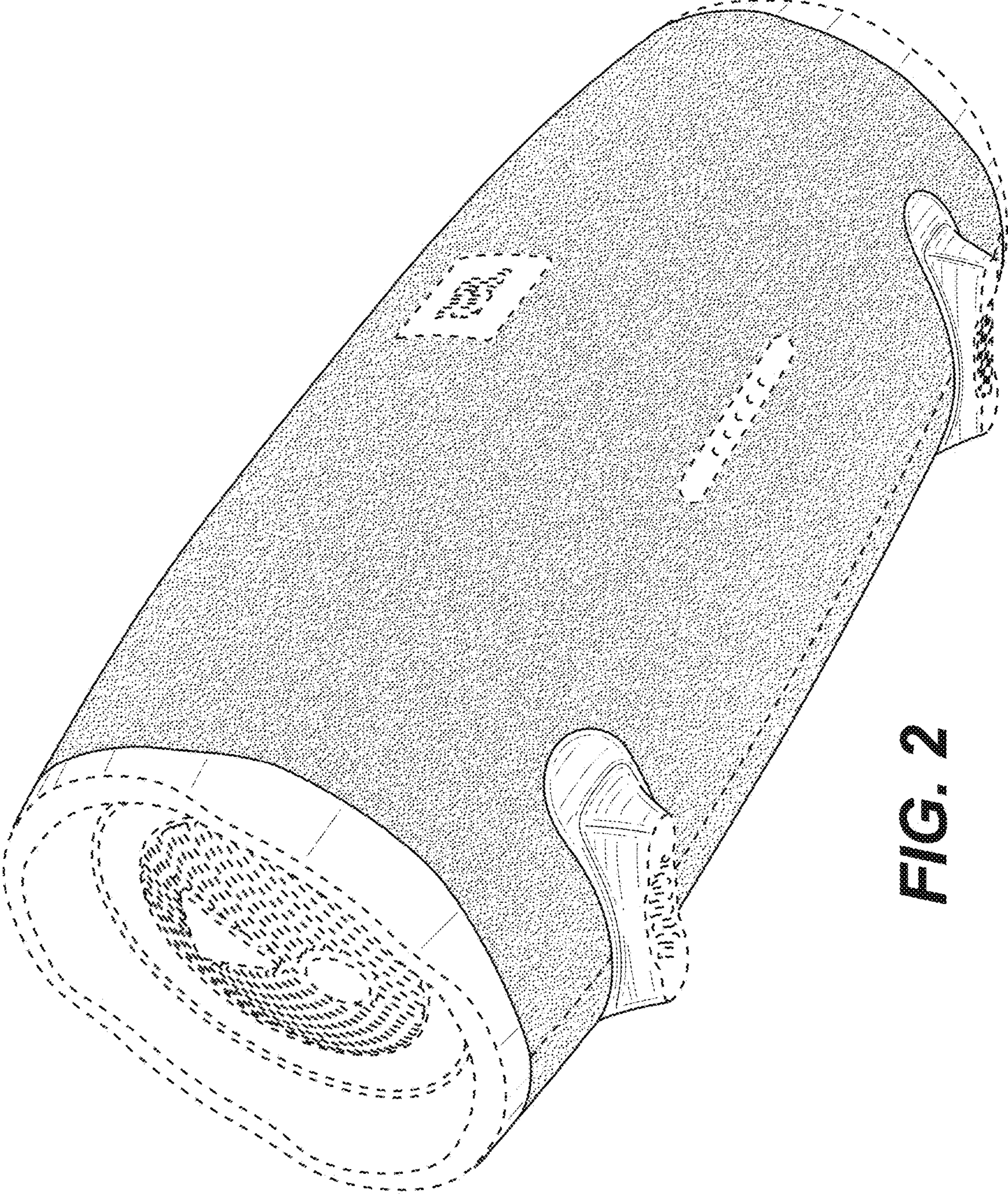
OTHER PUBLICATIONS

JBL Lifestyle Xtreme 2 Portable Bluetooth Speaker—Black, Amazon.com, Date first listed on Amazon: May 4, 2018, [online], [site visited May 23, 2019]. URL: [https://www.amazon.com/dp/B07CVPZJTV/ref=psdc\\_689637011\\_t2\\_B01I46V564](https://www.amazon.com/dp/B07CVPZJTV/ref=psdc_689637011_t2_B01I46V564) (Year: 2018).\*  
Bump Speaker, BumpSpeakers.com, [online], [site visited May 23, 2019]. URL: <https://bumpspeakers.com/products/sale> (Year: 2019).\*  
Red Bluetooth Speaker Super Bass Pill Style Speaker USB Charge Outdoor Speaker, More.com, [online], [site visited May 23, 2019]. URL: <https://www.more.com/shop/amazingforless-red-bluetooth-speaker-super-bass-pill-style-speaker-usb-charge-outdoor-speaker-p0c44d408d9f8e115aaba824cd86a757d.html> (Year: 2019).\*  
JBL Xtreme Quick Start Guide, JBL by Harman, 2015.  
JBL Xtreme Specification Sheet, JBL by Harman, 2015.

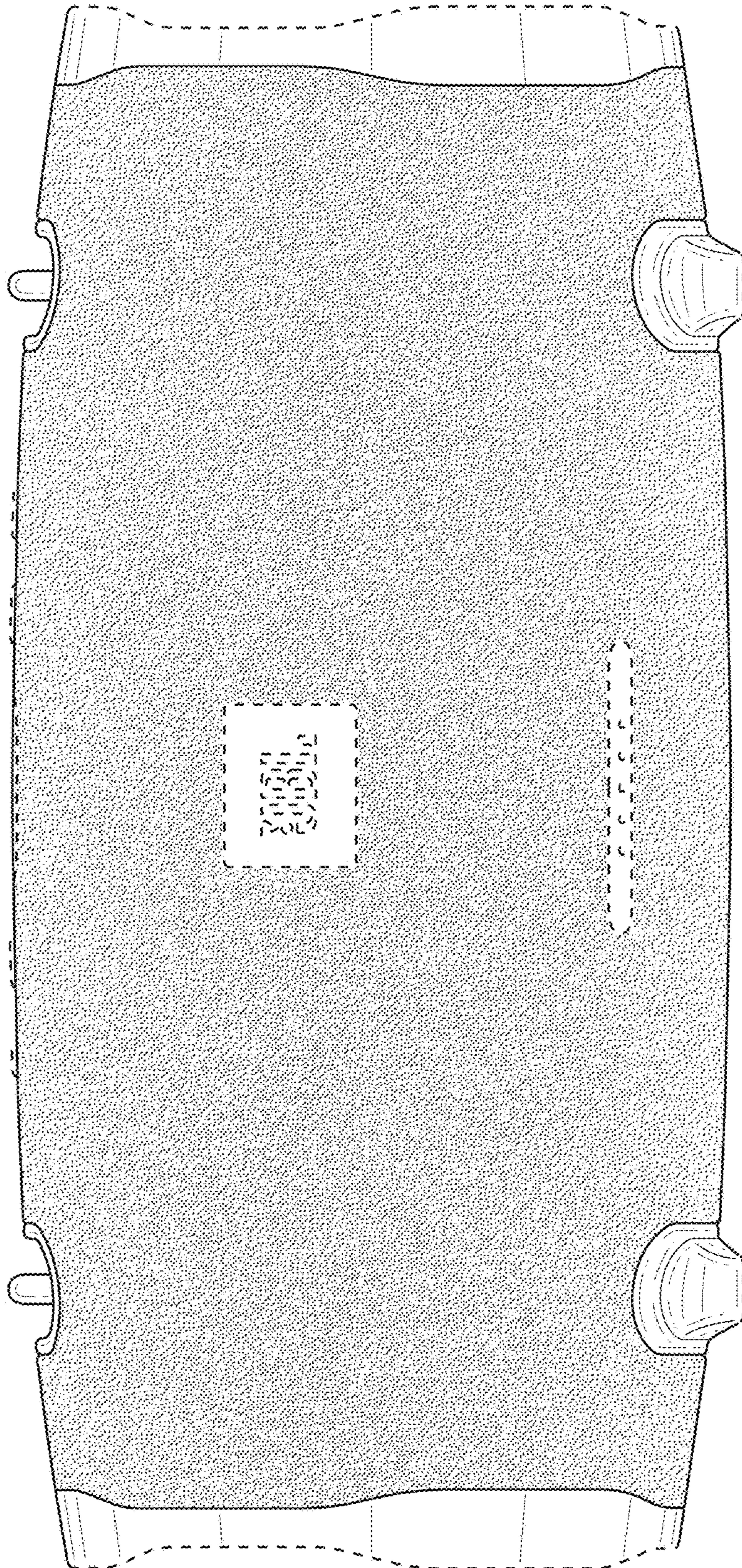
\* cited by examiner



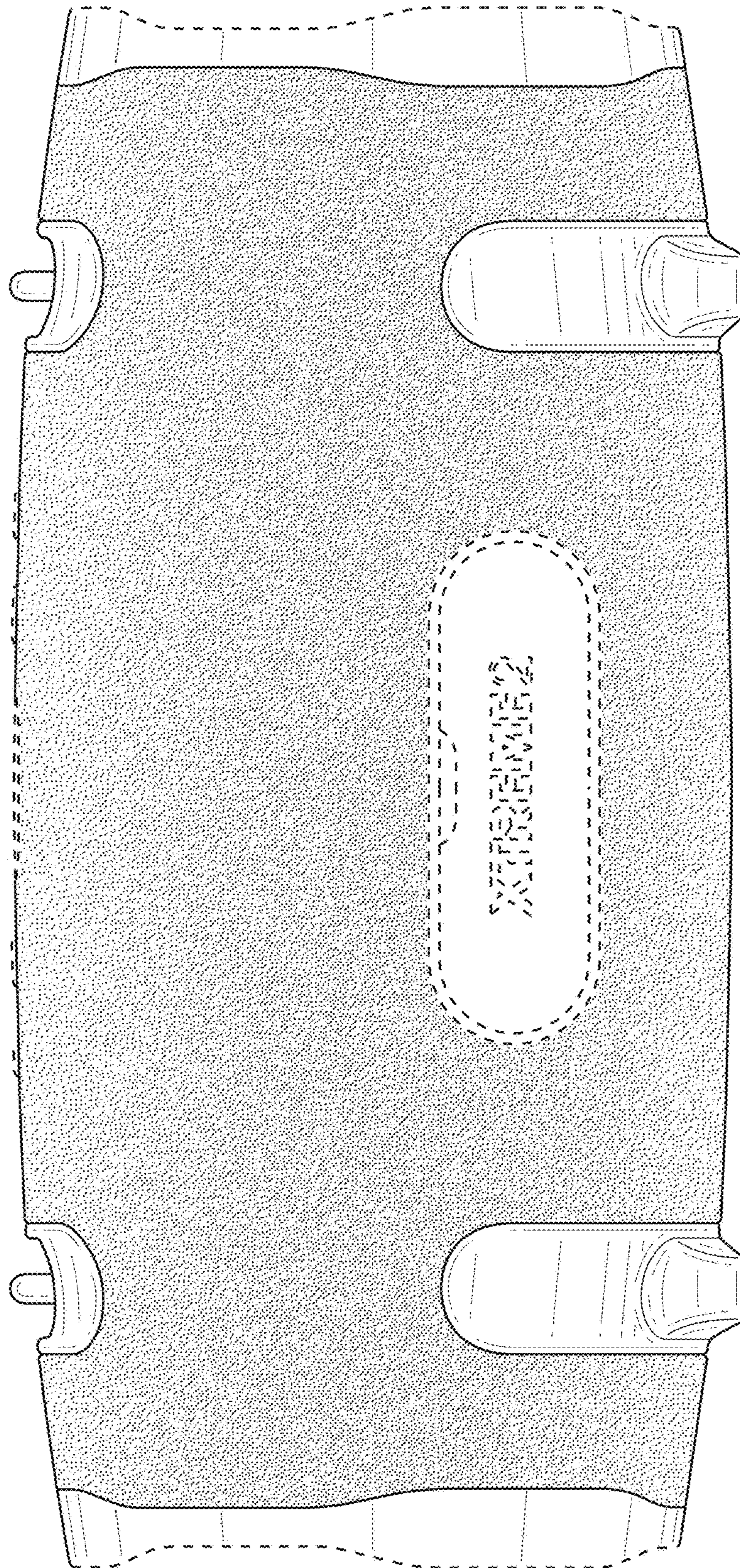
**FIG. 1**



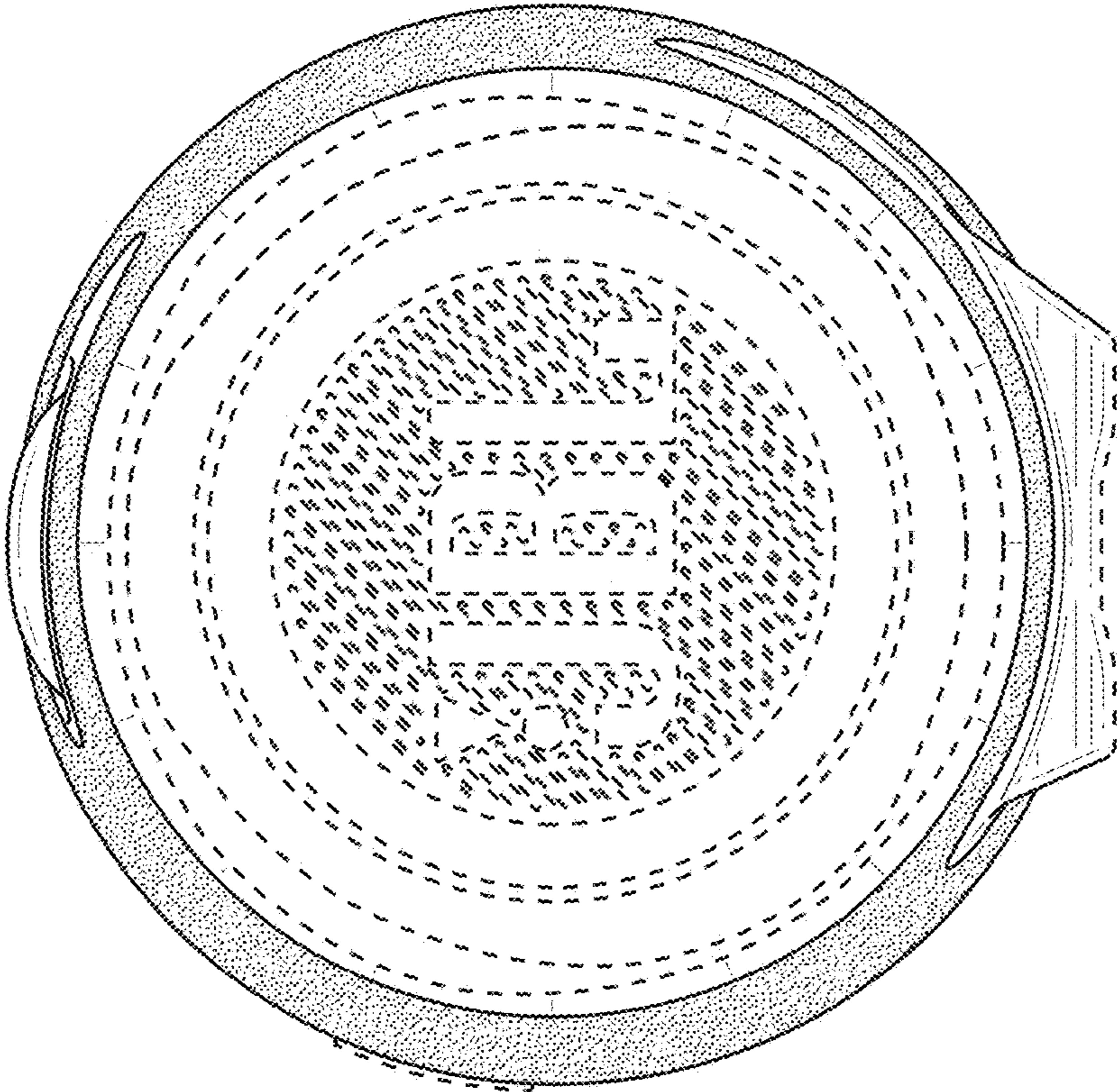
**FIG. 2**



**FIG. 3**



**FIG. 4**



**FIG. 5**

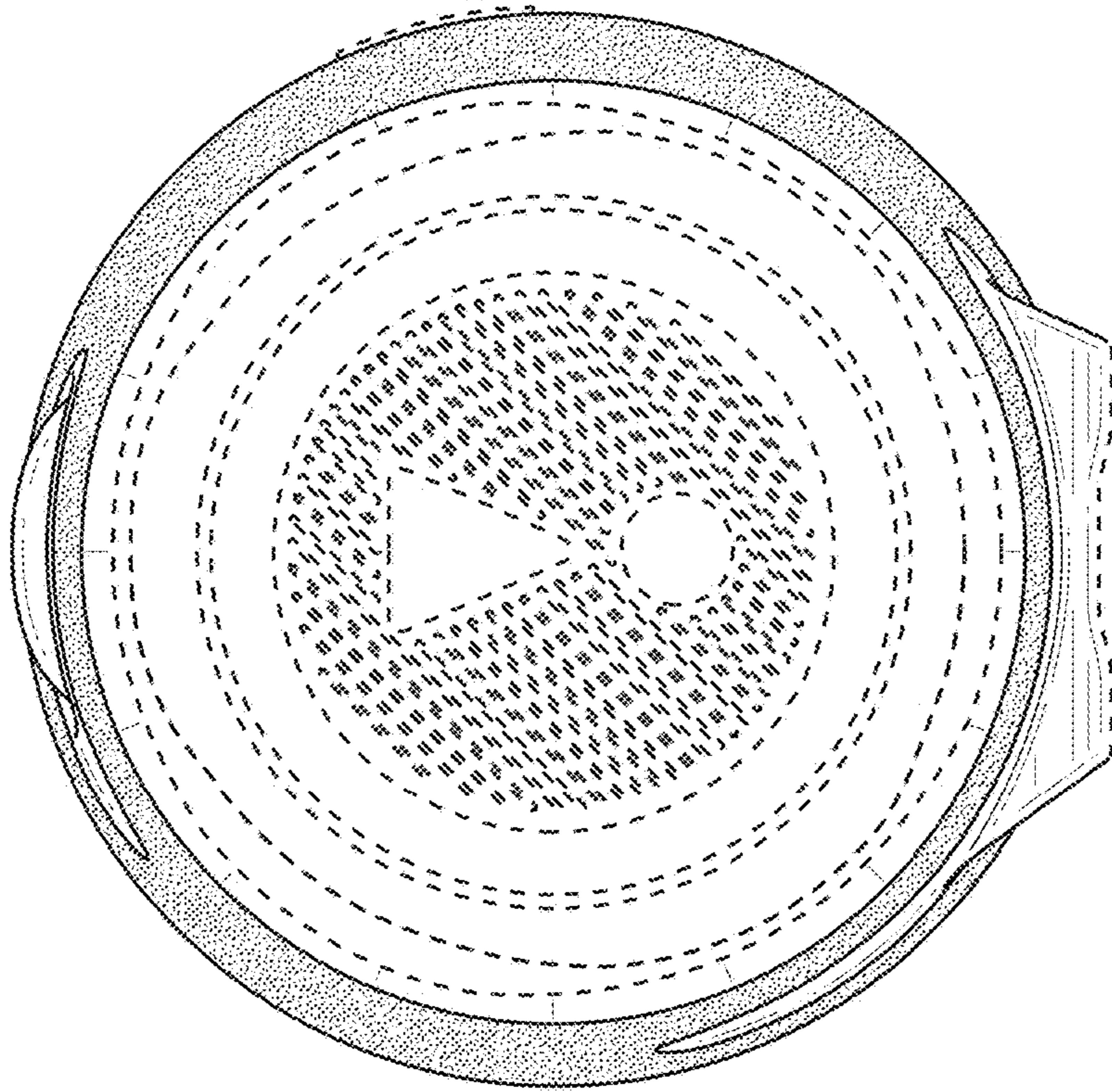
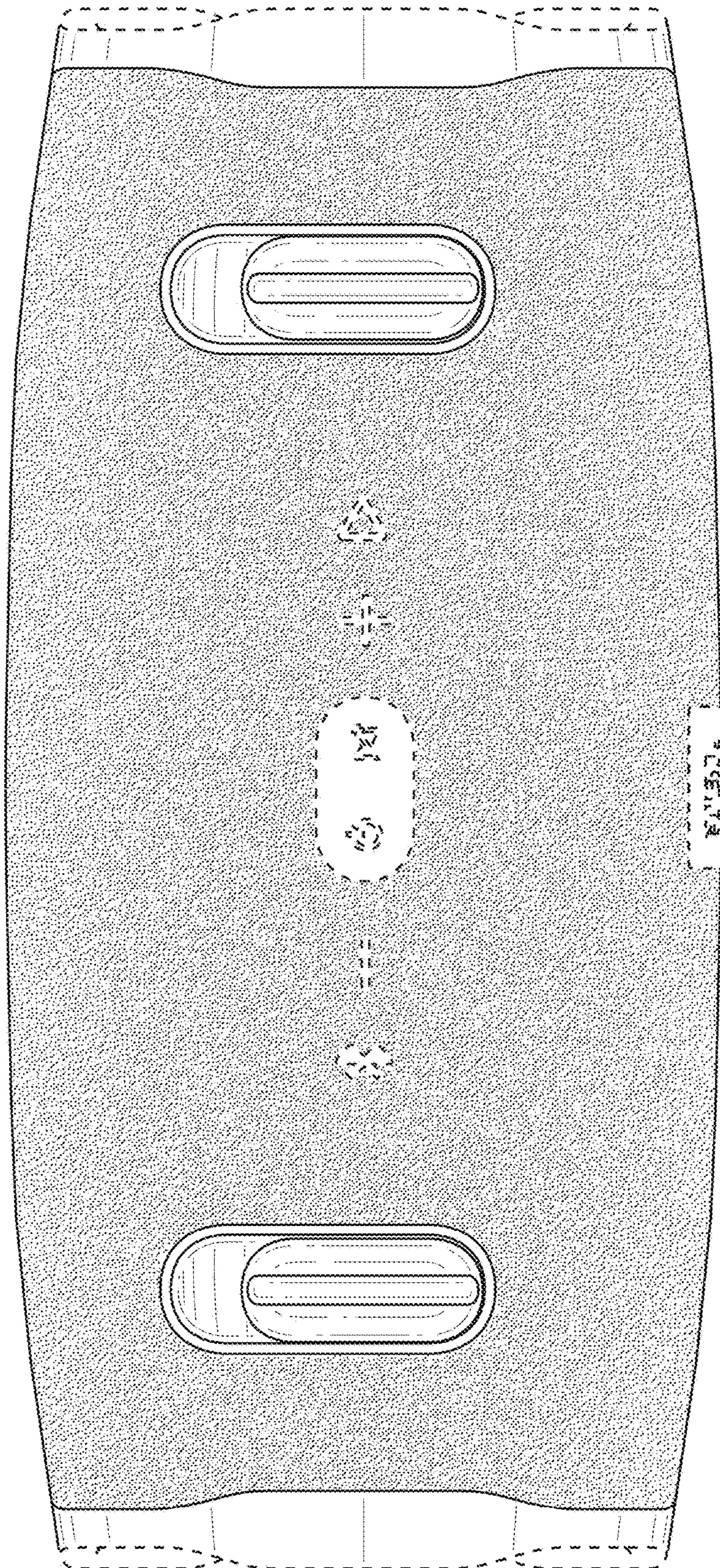


FIG. 6





**FIG. 7**

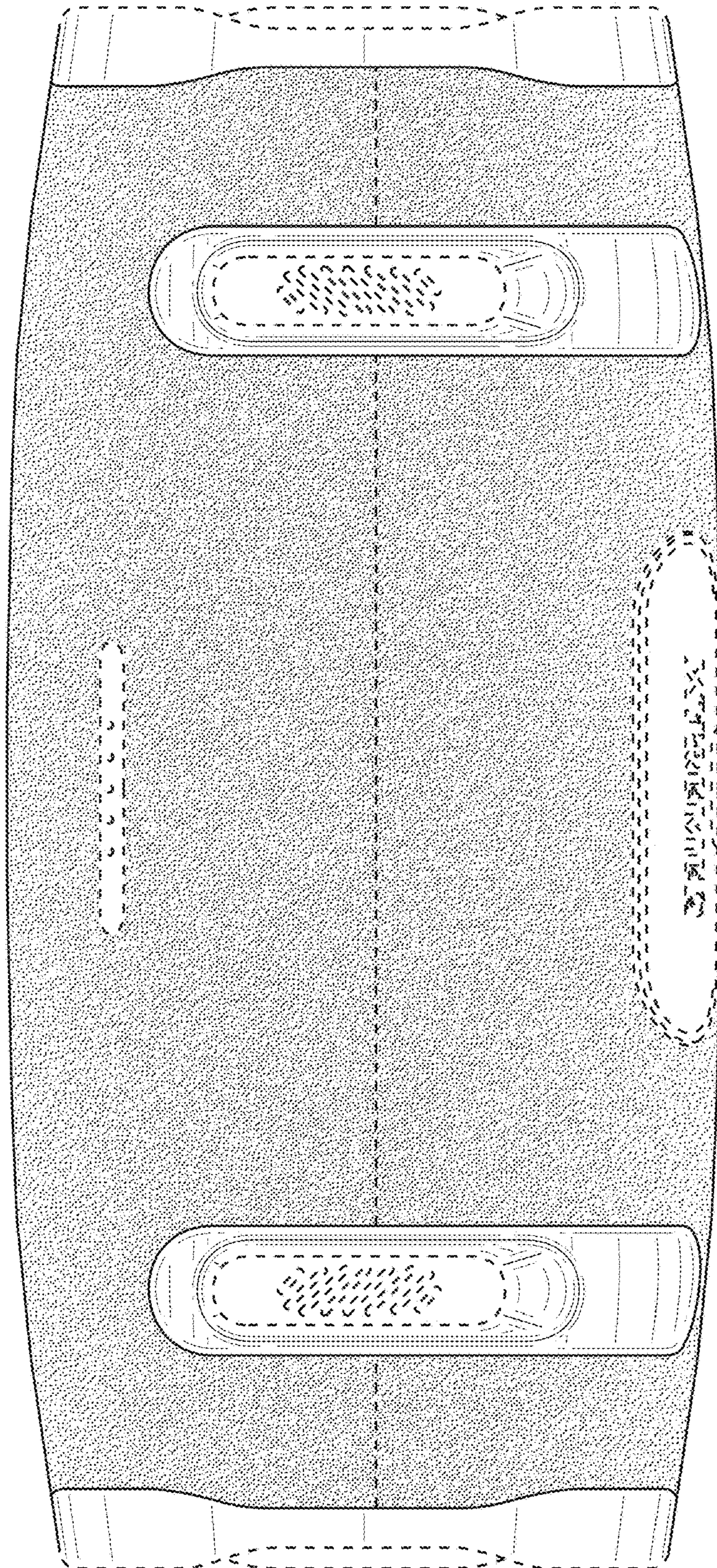
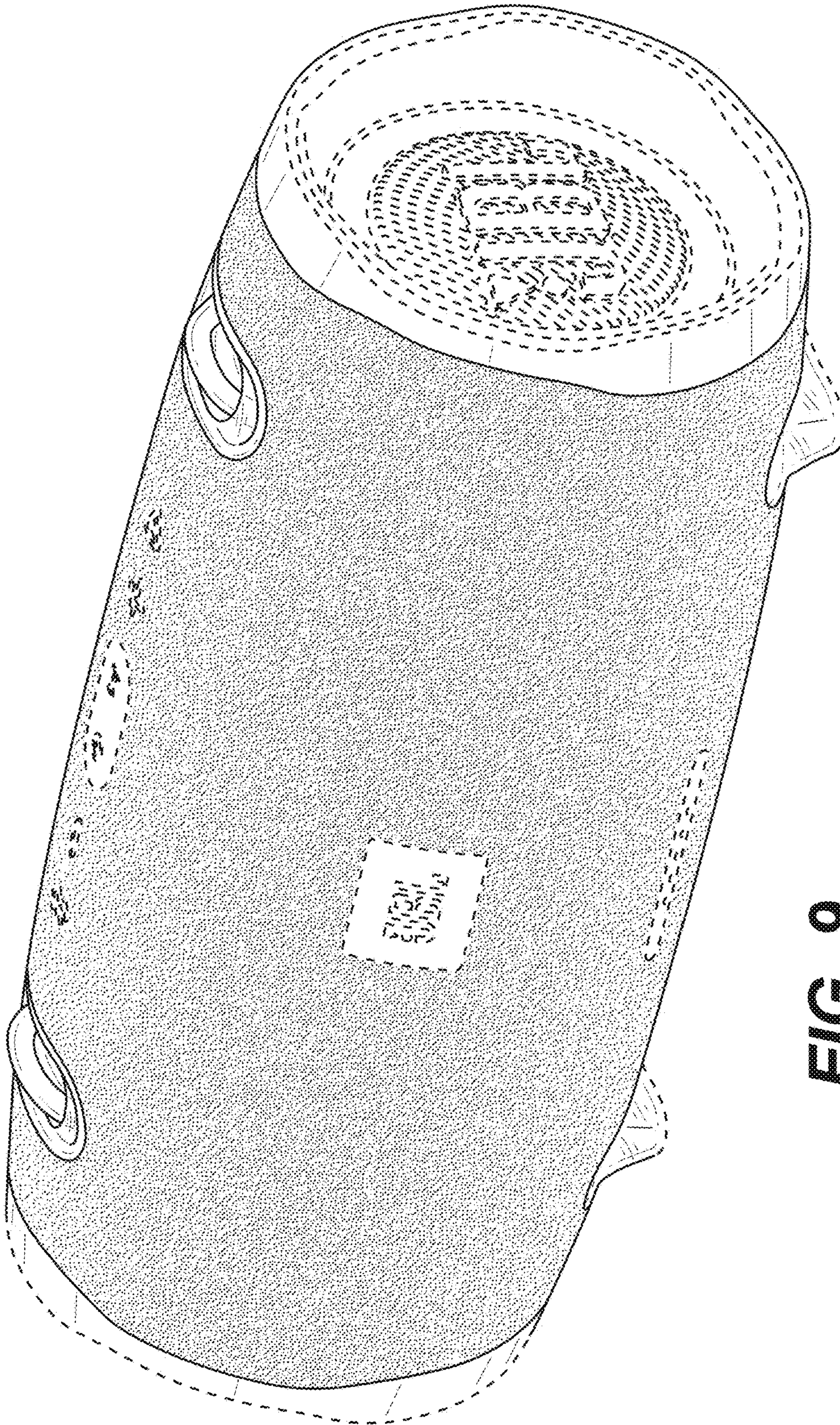
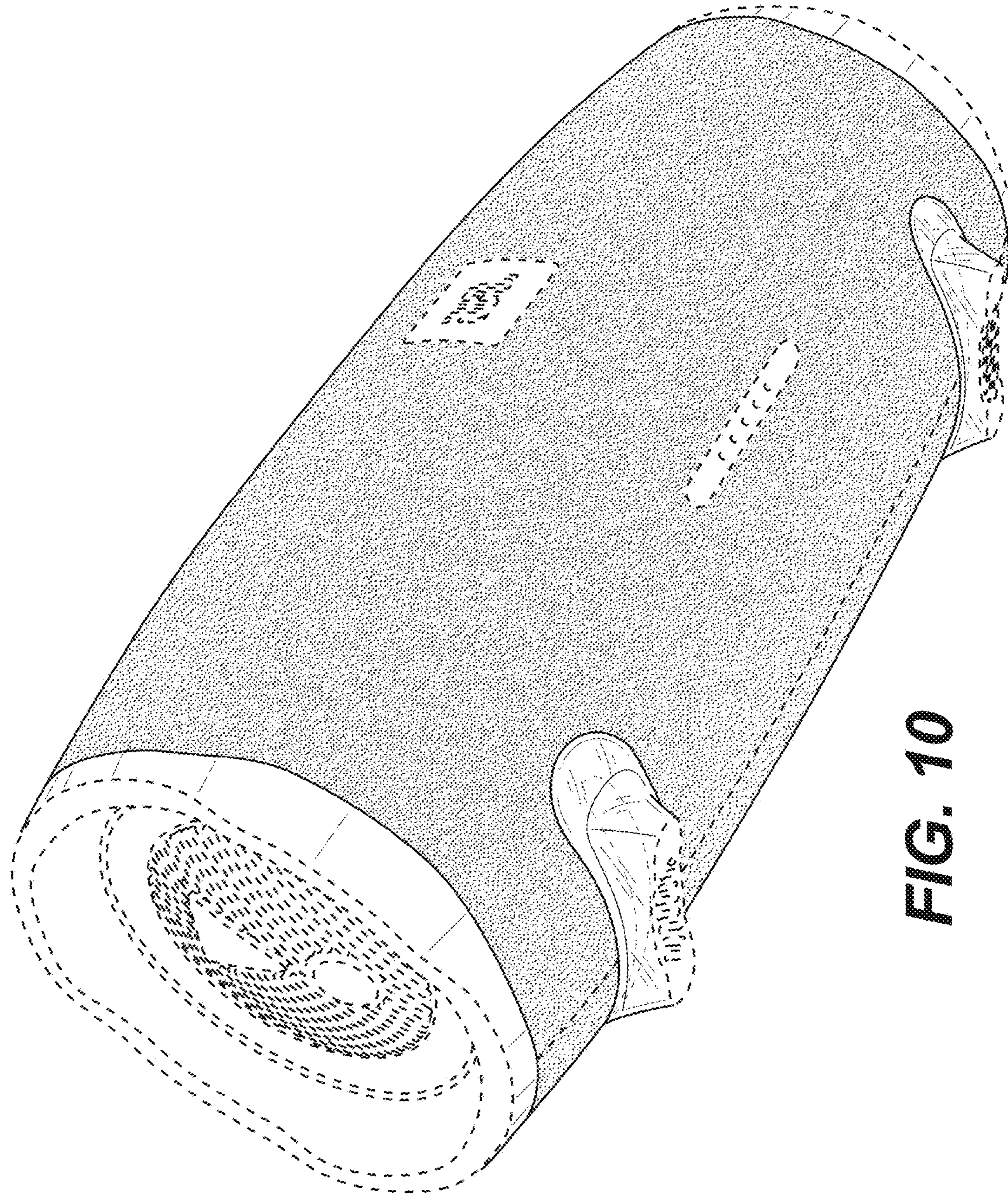


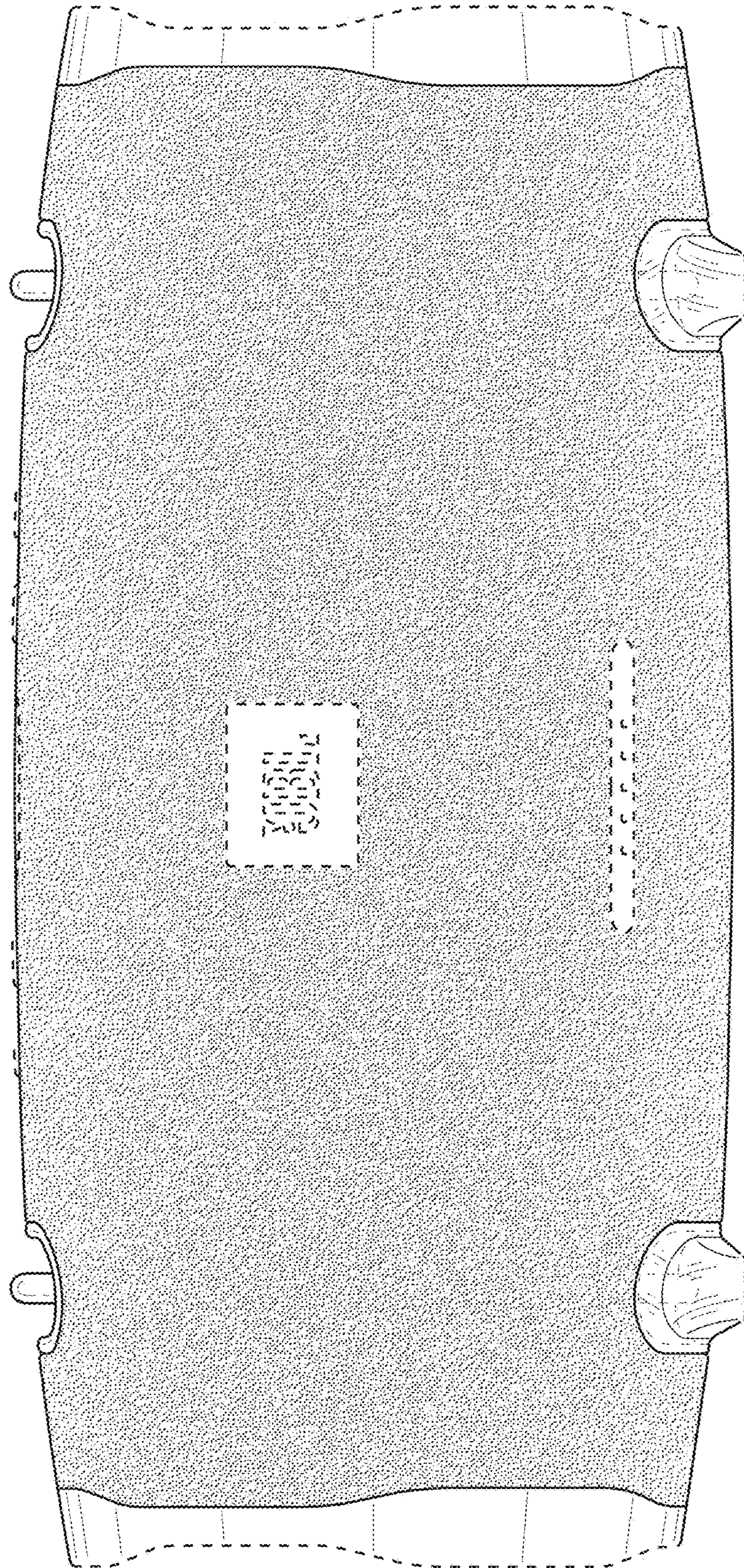
FIG. 8



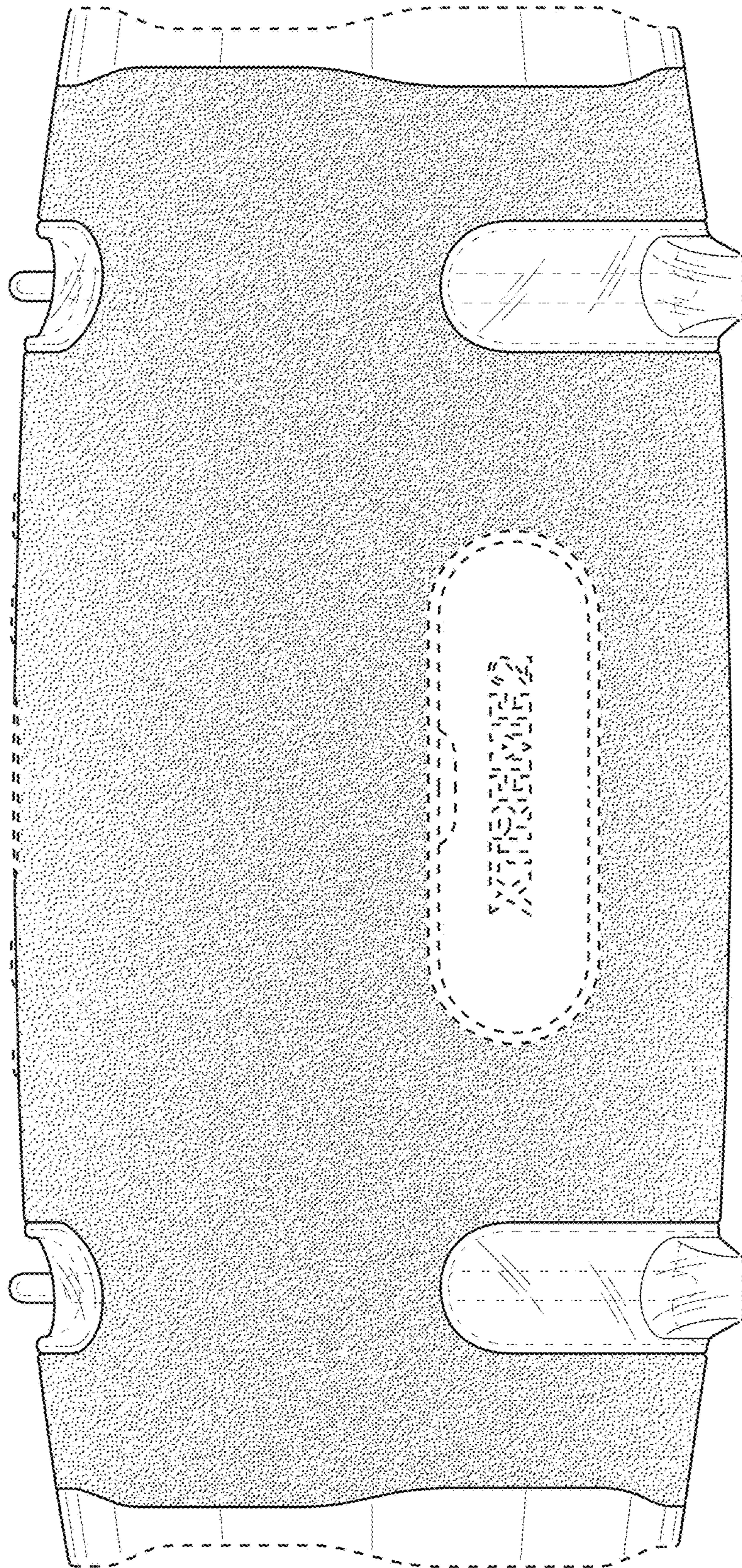
**FIG. 9**



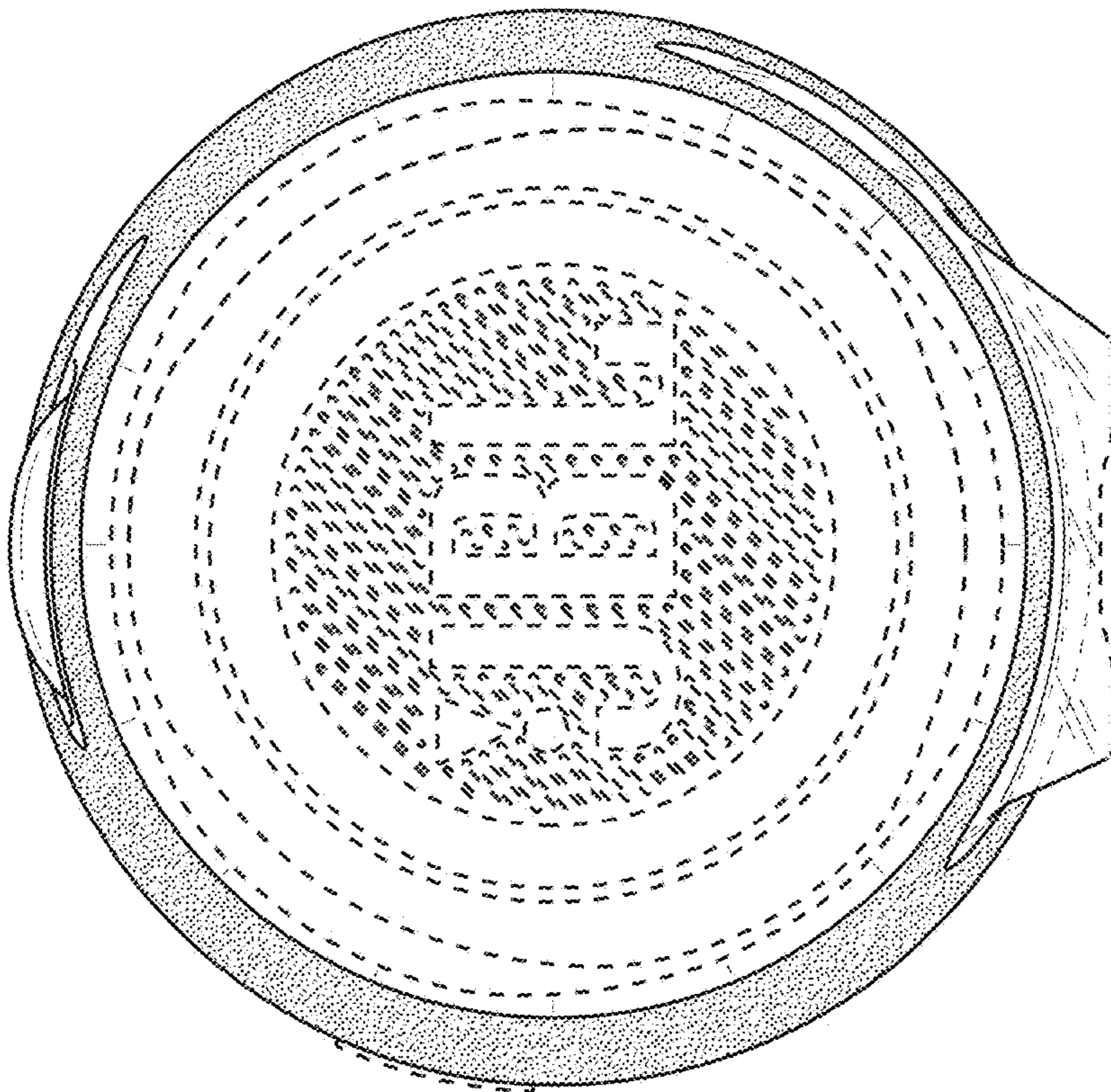
**FIG. 10**



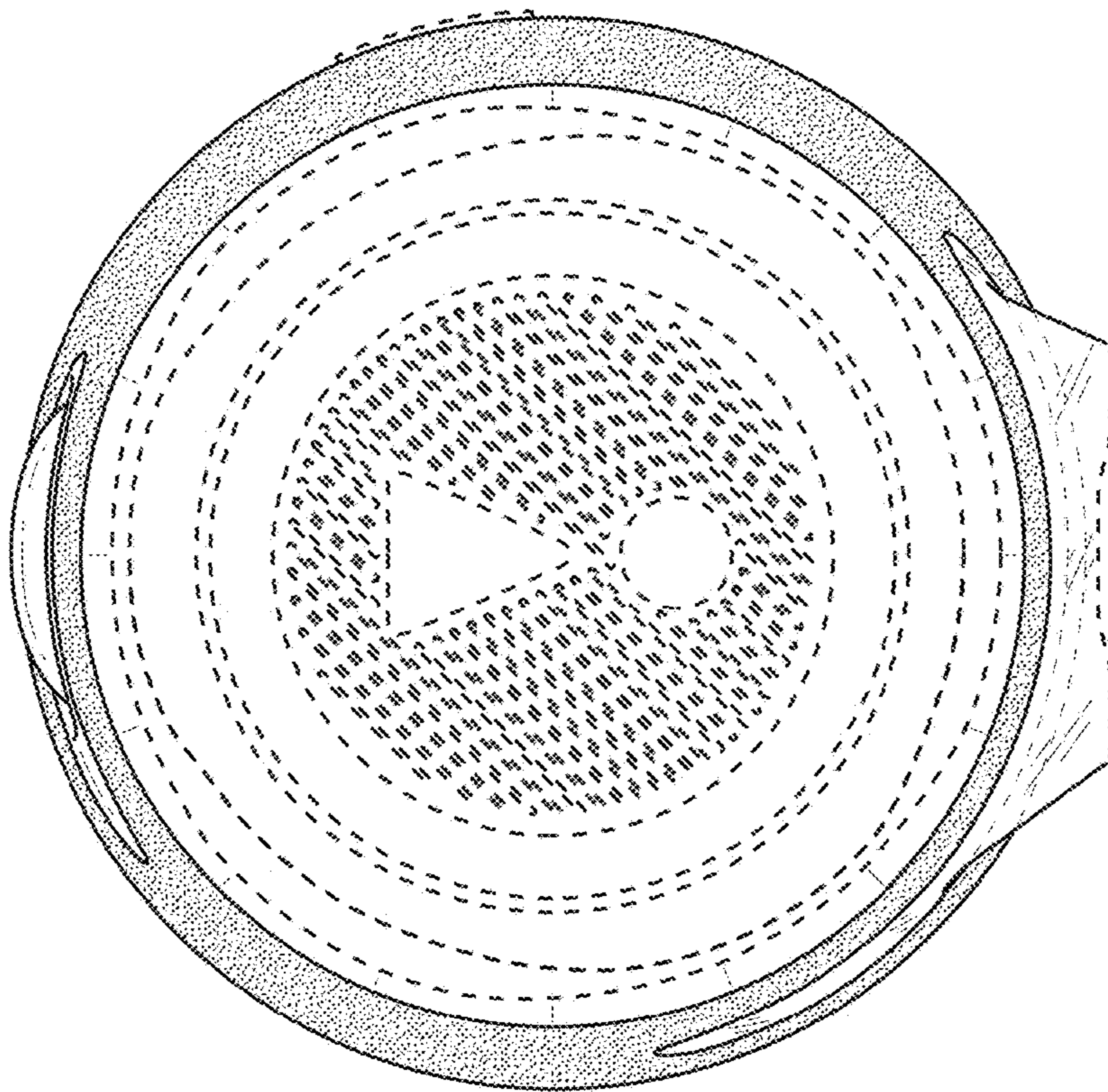
**FIG. 11**



**FIG. 12**

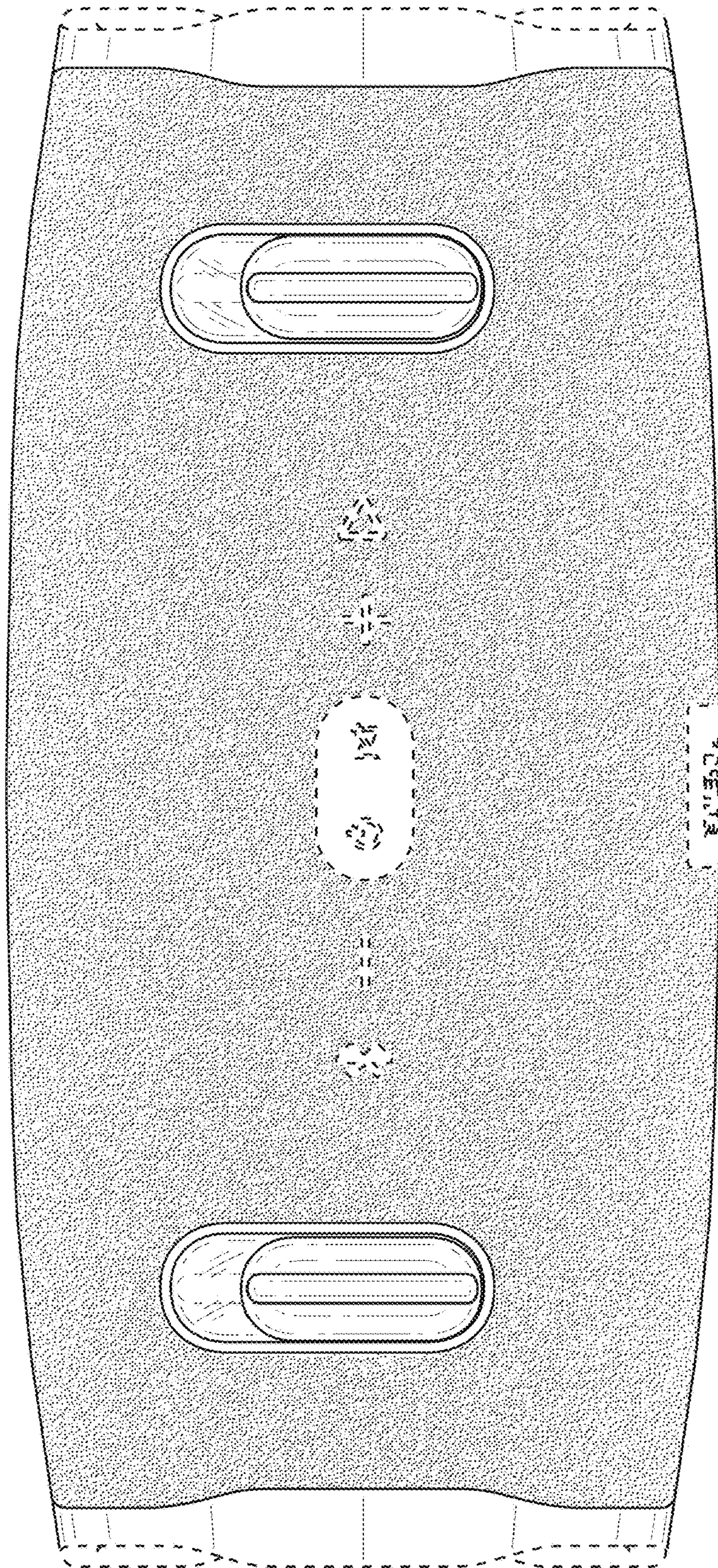


**FIG. 13**

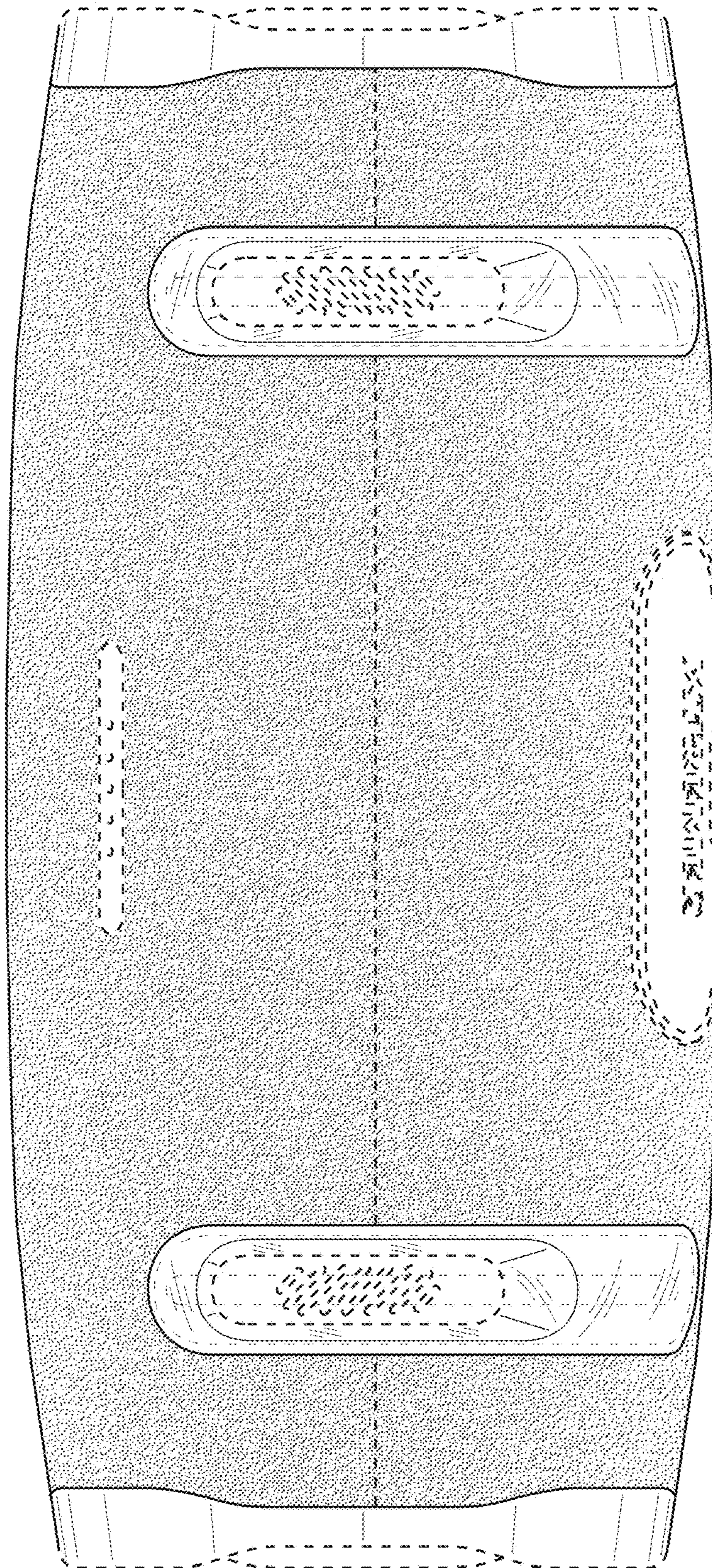


**FIG. 14**





**FIG. 15**



**FIG. 16**